

## HWD2108 Audio Power Amplifier

### Dual 105 mW Headphone Amplifier

#### General Description

The HWD2108 is a dual audio power amplifier capable of delivering 105mW per channel of continuous average power into a 16Ω load with 0.1% (THD+N) from a 5V power supply. audio power amplifiers were designed specifically to provide high quality output power with a minimal amount of external components using surface mount packaging. Since the HWD2108 does not require bootstrap capacitors or snubber networks, it is optimally suited for low-power portable systems.

The unity-gain stable HWD2108 can be configured by external gain-setting resistors.

#### Key Specifications

- THD+N at 1kHz at 105mW continuous average output power into 16Ω 0.1% (typ)
- THD+N at 1kHz at 70mW continuous average output power into 32Ω 0.1% (typ)
- Output power at 0.1% THD+N at 1kHz into 32Ω 70mW (typ)

#### Features

- LLP, MSOP, and SOP surface mount packaging
- Switch on/off click suppression
- Excellent power supply ripple rejection
- Unity-gain stable
- Minimum external components

#### Applications

- Headphone Amplifier
- Personal Computers
- Portable electronic devices

### Typical Application

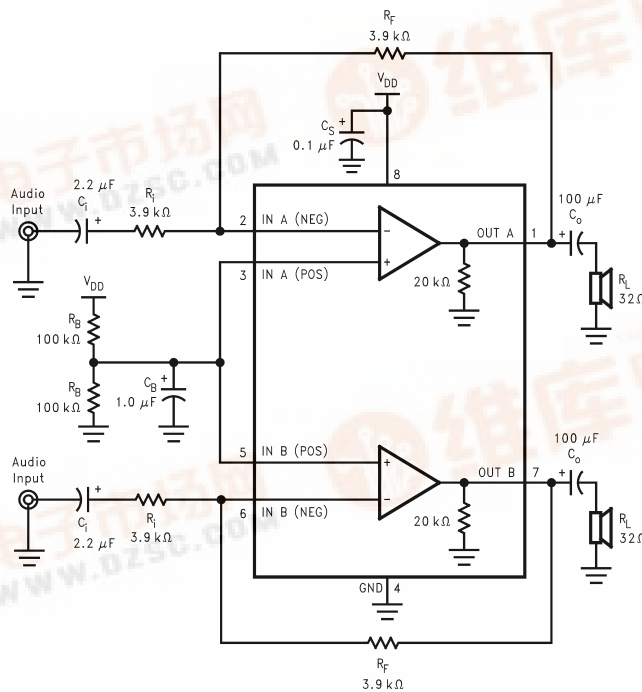

\*Refer to the **Application Information** Section for information concerning proper selection of the input and output coupling capacitors.

FIGURE 1. Typical Audio Amplifier Application Circuit

## Connection Diagrams

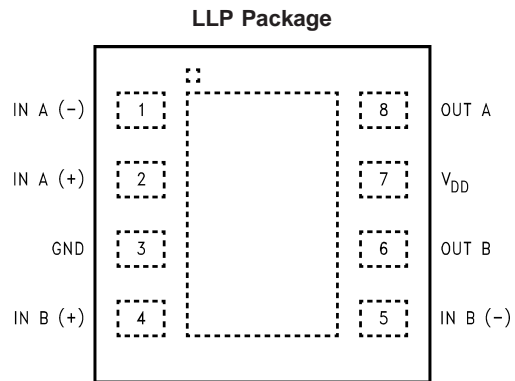

**Top View**  
Order Number HWD2108LD

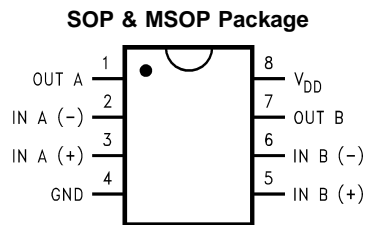

**Top View**  
Order Number HWD2108M, HWD2108MM

## Typical Application

## Absolute Maximum Ratings (Note 3)

If Military/Aerospace specified devices are required, please contact the CSMSC Semiconductor Sales Office/ Distributors for availability and specifications.

Supply Voltage	6.0V
Storage Temperature	-65°C to +150°C
Input Voltage	-0.3V to $V_{DD} + 0.3V$
Power Dissipation (Note 4)	Internally limited
ESD Susceptibility (Note 5)	3500V
ESD Susceptibility (Note 6)	250V
Junction Temperature	150°C
Soldering Information (Note 1)	
Small Outline Package	
Vapor Phase (60 seconds)	215°C
Infrared (15 seconds)	220°C
Thermal Resistance	

$\theta_{JC}$ (MSOP)	56°C/W
$\theta_{JA}$ (MSOP)	210°C/W
$\theta_{JC}$ (SOP)	35°C/W
$\theta_{JA}$ (SOP)	170°C/W
$\theta_{JC}$ (LLP)	15°C/W
$\theta_{JA}$ (LLP)	117°C/W (Note 9)
$\theta_{JA}$ (LLP)	150°C/W (Note 10)

## Operating Ratings

Temperature Range	$T_{MIN} \leq T_A \leq T_{MAX}$	-40°C $\leq T_A \leq$ 85°C
Supply Voltage		$2.0V \leq V_{DD} \leq 5.5V$

**Note 1:** See AN-450 "Surface Mounting and their Effects on Product Reliability" for other methods of soldering surface mount devices.

## Electrical Characteristics (Notes 2, 3)

The following specifications apply for  $V_{DD} = 5V$  unless otherwise specified, limits apply to  $T_A = 25^\circ C$ .

Symbol	Parameter	Conditions	HWD2108		Units (Limits)
			Typ (Note 7)	Limit (Note 8)	
$V_{DD}$	Supply Voltage			2.0 5.5	V (min) V (max)
$I_{DD}$	Supply Current	$V_{IN} = 0V, I_O = 0A$	1.2	3.0	mA (max)
$P_{tot}$	Total Power Dissipation	$V_{IN} = 0V, I_O = 0A$	6	16.5	mW (max)
$V_{OS}$	Input Offset Voltage	$V_{IN} = 0V$	10	50	mV (max)
$I_{bias}$	Input Bias Current		10		pA
$V_{CM}$	Common Mode Voltage		0		V
			4.3		V
$G_V$	Open-Loop Voltage Gain	$R_L = 5k\Omega$	67		dB
$I_O$	Max Output Current	THD+N < 0.1 %	70		mA
$R_O$	Output Resistance		0.1		$\Omega$
$V_O$	Output Swing	$R_L = 32\Omega, 0.1\% \text{ THD+N, Min}$	.3		V
		$R_L = 32\Omega, 0.1\% \text{ THD+N, Max}$	4.7		
PSRR	Power Supply Rejection Ratio	$C_b = 1.0\mu F, V_{ripple} = 100mV_{pp}, f = 100Hz$	89		dB
Crosstalk	Channel Separation	$R_L = 32\Omega$	75		dB
THD+N	Total Harmonic Distortion + Noise	$f = 1 \text{ kHz}$			
		$R_L = 16\Omega, V_O = 3.5V_{pp}$ (at 0 dB)	0.05		%
		$R_L = 16\Omega, V_O = 3.5V_{pp}$ (at 0 dB)	66		dB
		$R_L = 32\Omega, V_O = 3.5V_{pp}$ (at 0 dB)	0.05		%
		$R_L = 32\Omega, V_O = 3.5V_{pp}$ (at 0 dB)	66		dB
SNR	Signal-to-Noise Ratio	$V_O = 3.5V_{pp}$ (at 0 dB)	105		dB
$f_G$	Unity Gain Frequency	Open Loop, $R_L = 5k\Omega$	5.5		MHz
$P_O$	Output Power	THD+N = 0.1%, $f = 1 \text{ kHz}$			
		$R_L = 16\Omega$	105		mW
		$R_L = 32\Omega$	70	60	mW
		THD+N = 10%, $f = 1 \text{ kHz}$			
		$R_L = 16\Omega$	150		mW
		$R_L = 32\Omega$	90		mW
$C_I$	Input Capacitance		3		pF

## Electrical Characteristics (Notes 2, 3) (Continued)

The following specifications apply for  $V_{DD} = 5V$  unless otherwise specified, limits apply to  $T_A = 25^\circ C$ .

Symbol	Parameter	Conditions	HWD2108		Units (Limits)
			Typ (Note 7)	Limit (Note 8)	
$C_L$	Load Capacitance			200	pF
SR	Slew Rate	Unity Gain Inverting	3		V/ $\mu$ s

## Electrical Characteristics (Notes 2, 3)

The following specifications apply for  $V_{DD} = 3.3V$  unless otherwise specified, limits apply to  $T_A = 25^\circ C$ .

Symbol	Parameter	Conditions	Conditions		Units (Limits)
			Typ (Note 7)	Limit (Note 8)	
$I_{DD}$	Supply Current	$V_{IN} = 0V, I_O = 0A$	1.0		mA (max)
$V_{OS}$	Input Offset Voltage	$V_{IN} = 0V$	7		mV (max)
$P_o$	Output Power	THD+N = 0.1%, f = 1 kHz			
		$R_L = 16\Omega$	40		mW
		$R_L = 32\Omega$	28		mW
		THD+N = 10%, f = 1 kHz			
		$R_L = 16\Omega$	56		mW
		$R_L = 32\Omega$	38		mW

## Electrical Characteristics (Notes 2, 3)

The following specifications apply for  $V_{DD} = 2.6V$  unless otherwise specified, limits apply to  $T_A = 25^\circ C$ .

Symbol	Parameter	Conditions	Conditions		Units (Limits)
			Typ (Note 7)	Limit (Note 8)	
$I_{DD}$	Supply Current	$V_{IN} = 0V, I_O = 0A$	0.9		mA (max)
$V_{OS}$	Input Offset Voltage	$V_{IN} = 0V$	5		mV (max)
$P_o$	Output Power	THD+N = 0.1%, f = 1 kHz			
		$R_L = 16\Omega$	20		mW
		$R_L = 32\Omega$	16		mW
		THD+N = 10%, f = 1 kHz			
		$R_L = 16\Omega$	31		mW
		$R_L = 32\Omega$	22		mW

**Note 2:** All voltages are measured with respect to the ground pin, unless otherwise specified.

**Note 3:** *Absolute Maximum Ratings* indicate limits beyond which damage to the device may occur. *Operating Ratings* indicate conditions for which the device is functional, but do not guarantee specific performance limits. *Electrical Characteristics* state DC and AC electrical specifications under particular test conditions which guarantee specific performance limits. This assumes that the device is within the Operating Ratings. Specifications are not guaranteed for parameters where no limit is given, however, the typical value is a good indication of device performance.

**Note 4:** The maximum power dissipation must be derated at elevated temperatures and is dictated by  $T_{JMAX}$ ,  $\theta_{JA}$ , and the ambient temperature  $T_A$ . The maximum allowable power dissipation is  $P_{DMAX} = (T_{JMAX} - T_A) / \theta_{JA}$ . For the HWD2108,  $T_{JMAX} = 150^\circ C$ , and the typical junction-to-ambient thermal resistance, when board mounted, is 210°C/W for package MUA08A and 170°C/W for package M08A.

**Note 5:** Human body model, 100 pF discharged through a 1.5 k $\Omega$  resistor.

**Note 6:** Machine Model, 220 pF–240 pF discharged through all pins.

**Note 7:** Typicals are measured at 25°C and represent the parametric norm.

**Note 8:** Tested limits are guaranteed to CSMSC's AOQL (Average Outgoing Quality Level). Datasheet min/max specification limits are guaranteed by design, test, or statistical analysis.

**Note 9:** The given  $\theta_{JA}$  is for an HWD2108 packaged in an LDA08B with the Exposed-DAP soldered to a printed circuit board copper pad with an area equivalent to that of the Exposed-DAP itself.

**Note 10:** The given  $\theta_{JA}$  is for an HWD2108 packaged in an LDA08B with the Exposed-DAP not soldered to any printed circuit board copper.

## External Components Description *(Figure 1)*

Components	Functional Description
1. $R_i$	The inverting input resistance, along with $R_f$ , set the closed-loop gain. $R_i$ , along with $C_i$ , form a high pass filter with $f_c = 1/(2\pi R_i C_i)$ .
2. $C_i$	The input coupling capacitor blocks DC voltage at the amplifier's input terminals. $C_i$ , along with $R_i$ , create a highpass filter with $f_c = 1/(2\pi R_i C_i)$ . Refer to the section, <b>Selecting Proper External Components</b> , for an explanation of determining the value of $C_i$ .
3. $R_f$	The feedback resistance, along with $R_i$ , set closed-loop gain.
4. $C_S$	This is the supply bypass capacitor. It provides power supply filtering. Refer to the <b>Application Information</b> section for proper placement and selection of the supply bypass capacitor.
5. $C_B$	This is the half-supply bypass pin capacitor. It provides half-supply filtering. Refer to the section, <b>Selecting Proper External Components</b> , for information concerning proper placement and selection of $C_B$ .
6. $C_O$	This is the output coupling capacitor. It blocks the DC voltage at the amplifier's output and forms a high pass filter with $R_L$ at $f_o = 1/(2\pi R_L C_O)$
7. $R_B$	This is the resistor which forms a voltage divider that provides $1/2 V_{DD}$ to the non-inverting input of the amplifier.

## Typical Performance Characteristics

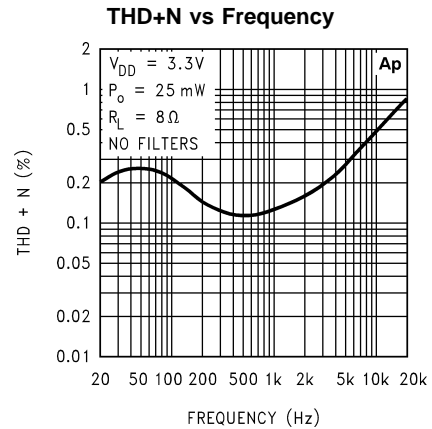
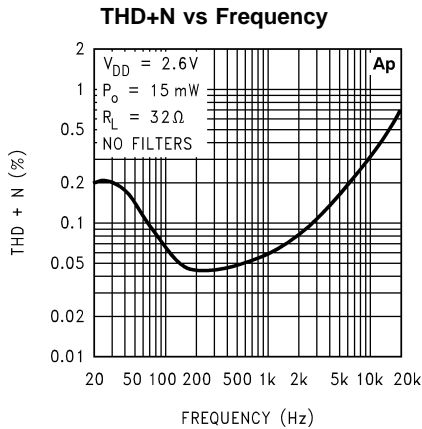
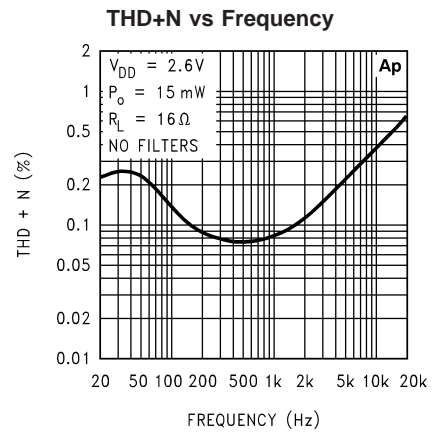
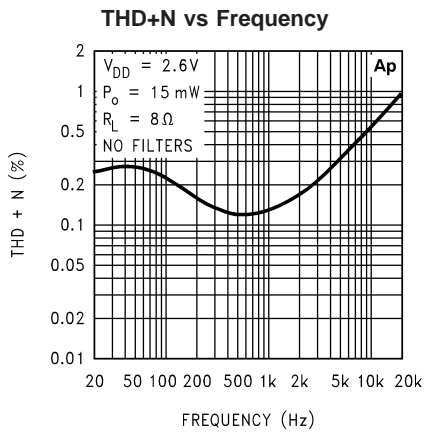

# Typical Performance Characteristics (Continued)

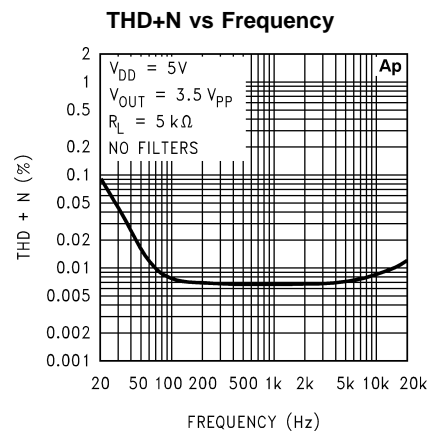
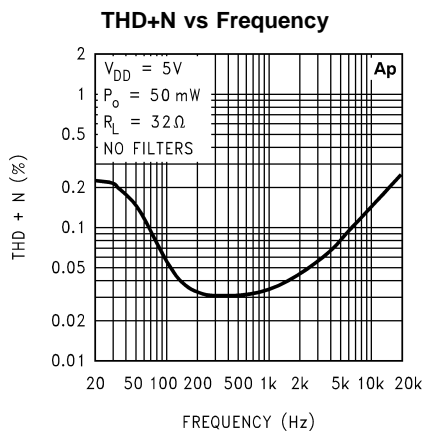
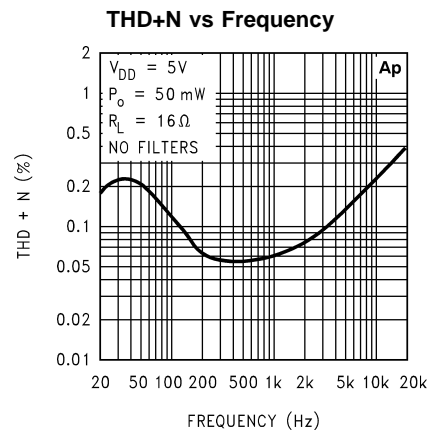
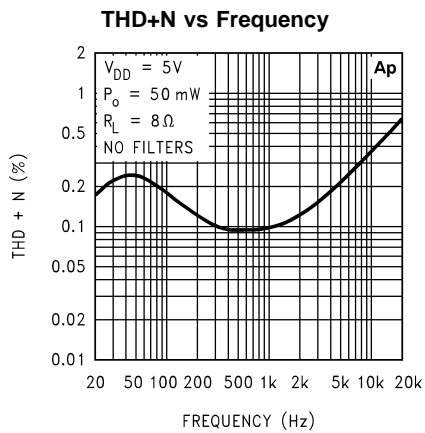
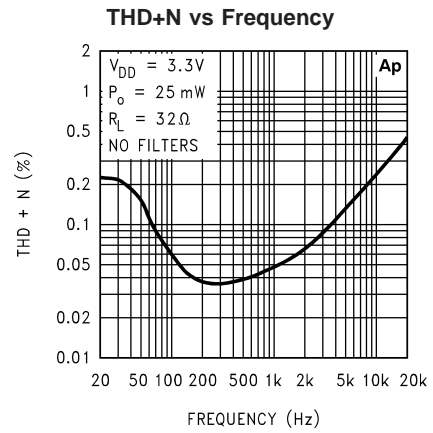
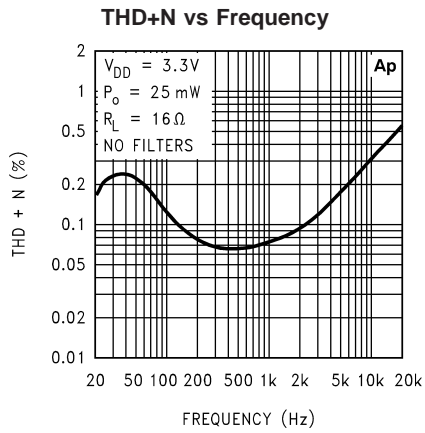

# Typical Performance Characteristics (Continued)

**THD+N vs Output Power**

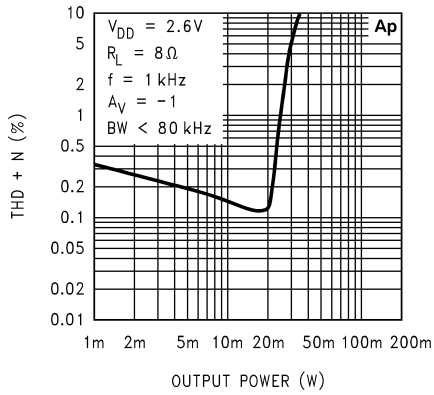

**THD+N vs Output Power**

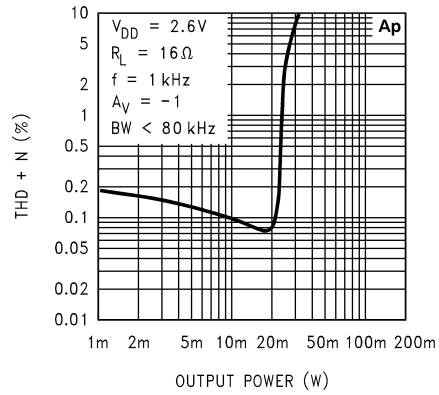

**THD+N vs Output Power**

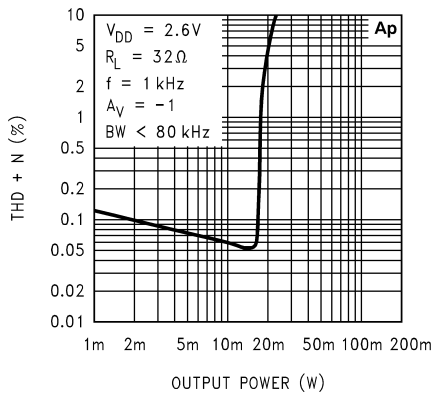

**THD+N vs Output Power**

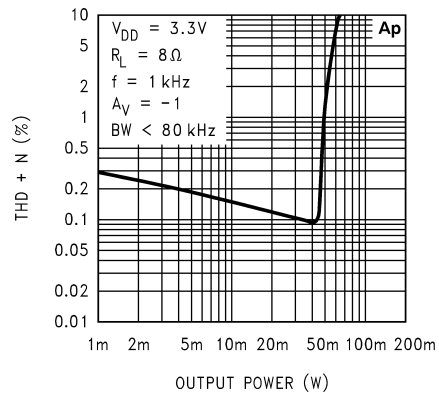

**THD+N vs Output Power**

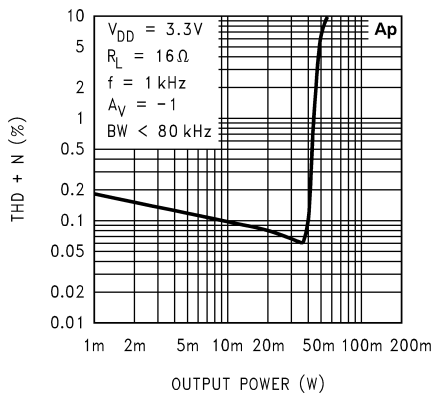

**THD+N vs Output Power**

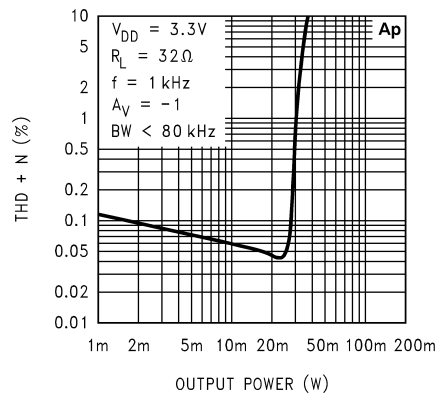

# Typical Performance Characteristics (Continued)

**THD+N vs Output Power**

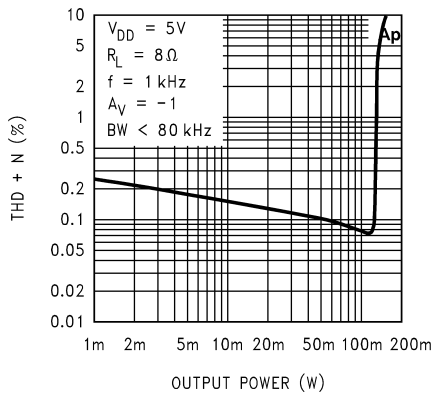

**THD+N vs Output Power**

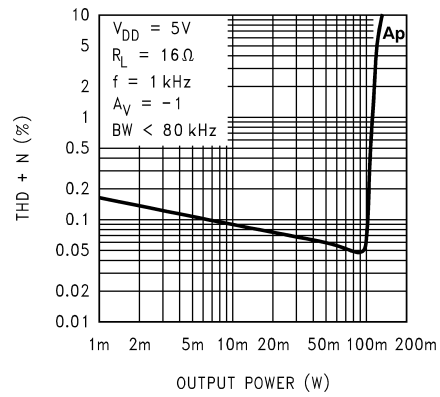

**THD+N vs Output Power**

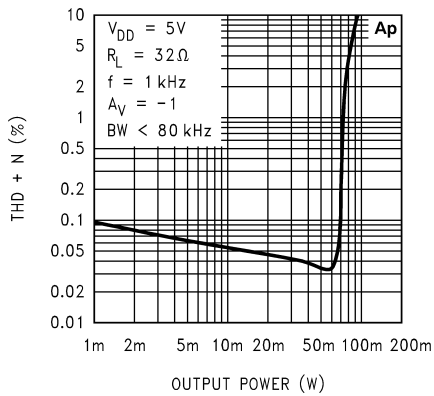

**Output Power vs Load Resistance**

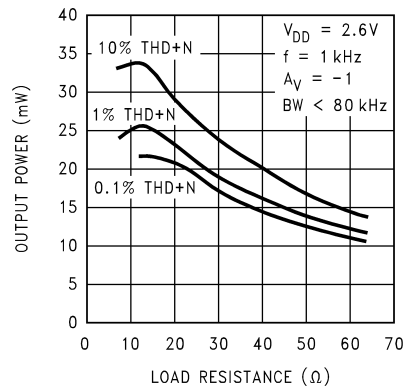

**Output Power vs Load Resistance**

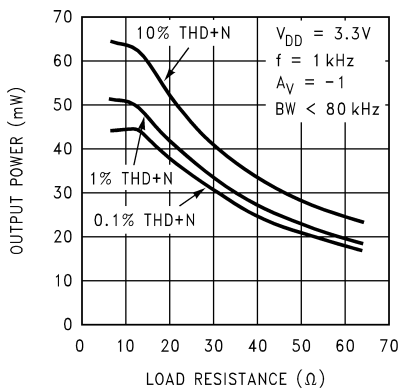

**Output Power vs Load Resistance**

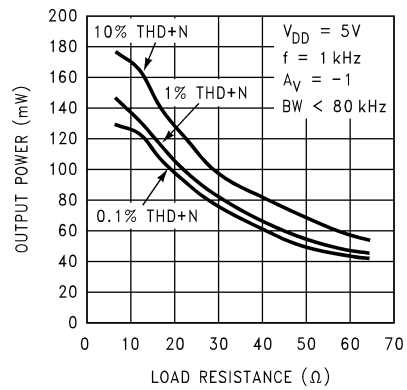



# Typical Performance Characteristics (Continued)

**Output Power vs Supply Voltage**

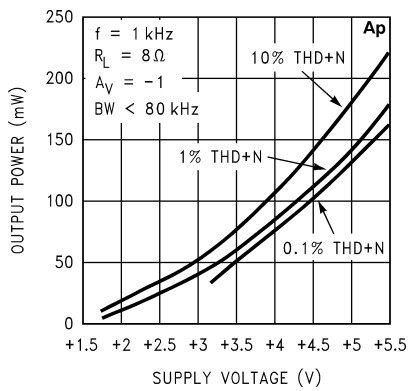

**Output Power vs Power Supply**

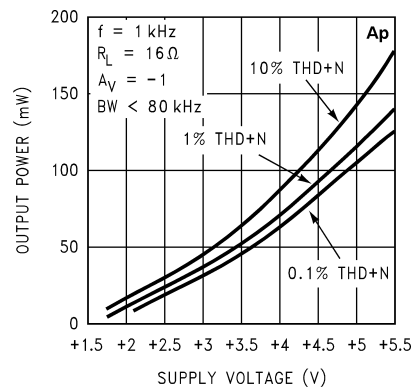

**Output Power vs Power Supply**

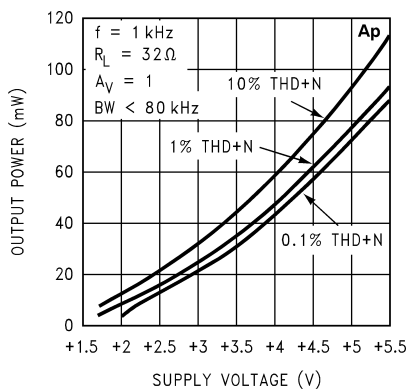

**Clipping Voltage vs Supply Voltage**

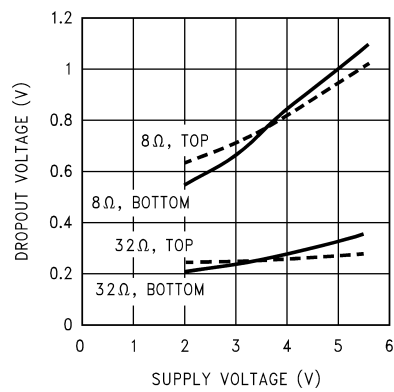

**Power Dissipation vs Output Power**

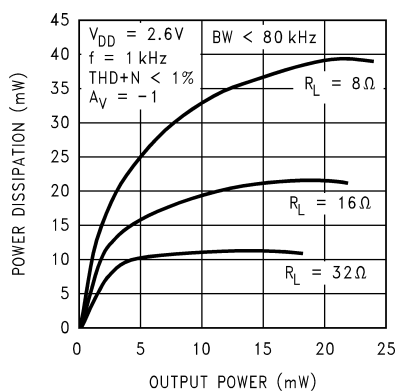

**Power Dissipation vs Output Power**

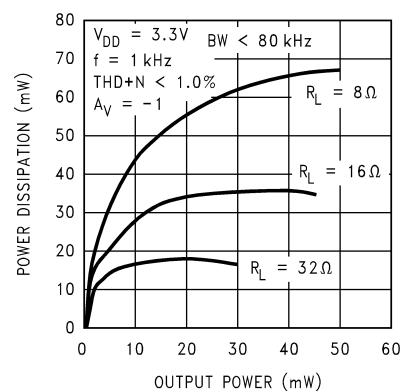

# Typical Performance Characteristics (Continued)

**Power Dissipation vs Output Power**

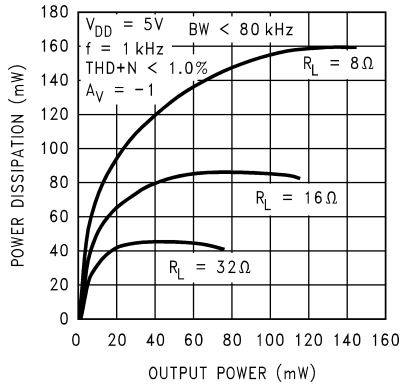

**Channel Separation**

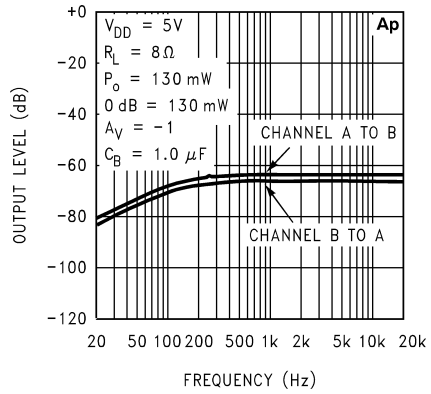

**Channel Separation**

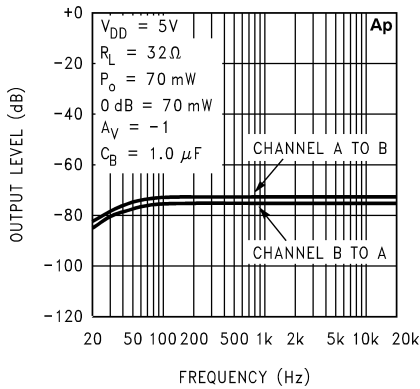

**Noise Floor**

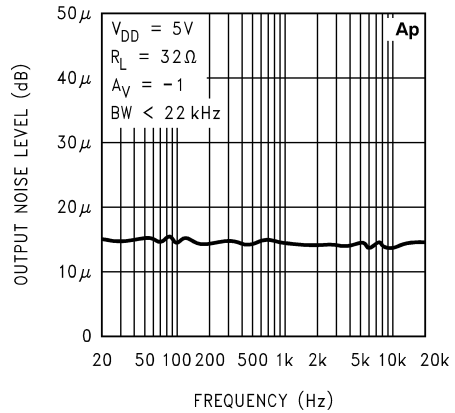

**Power Supply Rejection Ratio**

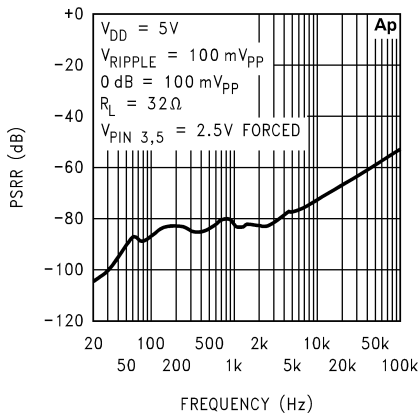

**Open Loop Frequency Response**

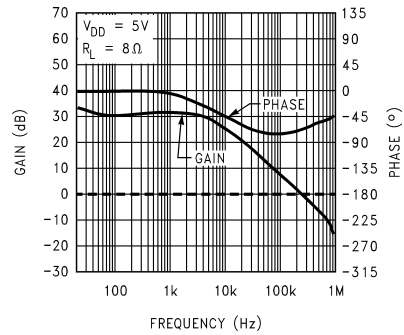

# Typical Performance Characteristics (Continued)

**Open Loop Frequency Response**

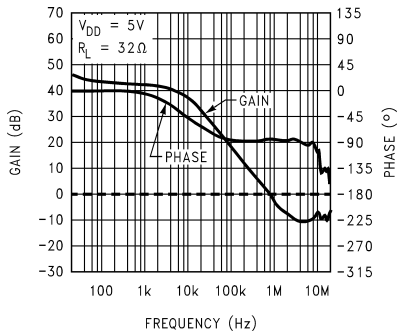

**Open Loop Frequency Response**

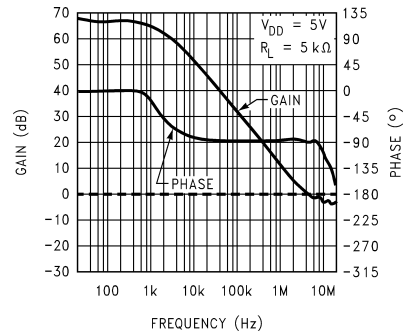

**Supply Current vs Supply Voltage**

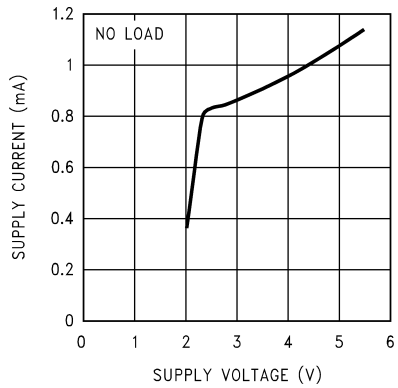

**Frequency Response vs Output Capacitor Size**

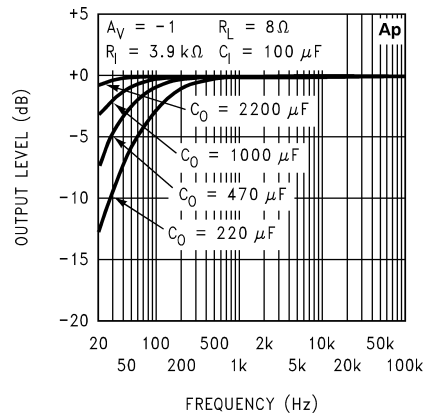

**Frequency Response vs Output Capacitor Size**

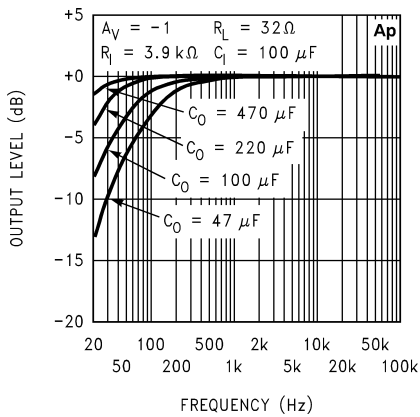

**Frequency Response vs Output Capacitor Size**

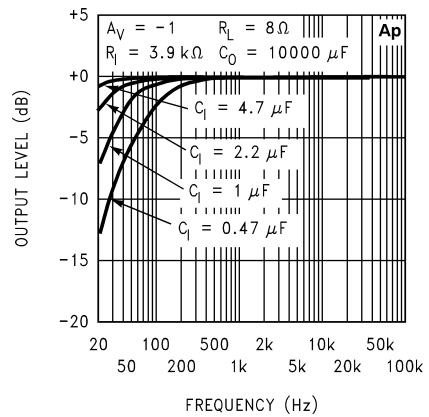

# Typical Performance Characteristics (Continued)

**Typical Application  
Frequency Response**

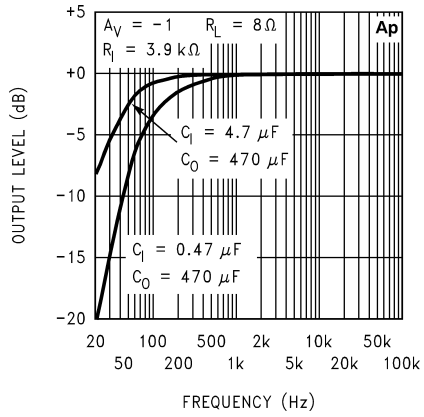

**Typical Application  
Frequency Response**

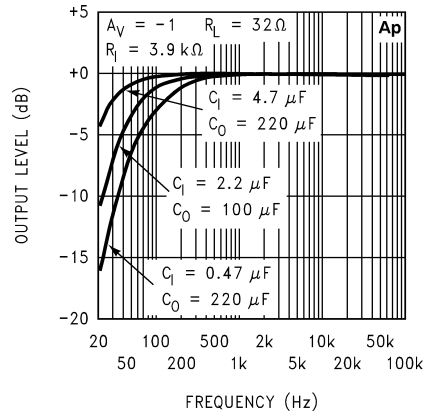

## Application Information

### EXPOSED-DAP PACKAGE PCB MOUNTING CONSIDERATION

The HWD2108's exposed-dap (die attach paddle) package (LD) provides a low thermal resistance between the die and the PCB to which the part is mounted and soldered. This allows rapid heat transfer from the die to the surrounding PCB copper traces, ground plane, and surrounding air.

The LD package should have its DAP soldered to a copper pad on the PCB. The DAP's PCB copper pad may be connected to a large plane of continuous unbroken copper. This plane forms a thermal mass, heat sink, and radiation area.

However, since the HWD2108 is designed for headphone applications, connecting a copper plane to the DAP's PCB copper pad is not required. The HWD2108's Power Dissipation vs Output Power Curve in the **Typical Performance Characteristics** shows that the maximum power dissipated is just 45mW per amplifier with a 5V power supply and a 32Ω load. Further detailed and specific information concerning PCB layout, fabrication, and mounting an LD (LLP) package is available from CSMSC Semiconductor's Package Engineering Group under application note AN1187.

### POWER DISSIPATION

Power dissipation is a major concern when using any power amplifier and must be thoroughly understood to ensure a successful design. Equation 1 states the maximum power dissipation point for a single-ended amplifier operating at a given supply voltage and driving a specified output load.

$$P_{DMAX} = (V_{DD})^2 / (2\pi^2 R_L) \quad (1)$$

Since the HWD2108 has two operational amplifiers in one package, the maximum internal power dissipation point is twice that of the number which results from Equation 1. Even with the large internal power dissipation, the HWD2108 does not require heat sinking over a large range of ambient temperature. From Equation 1, assuming a 5V power supply and a 32Ω load, the maximum power dissipation point is 40mW per amplifier. Thus the maximum package dissipation point is 80mW. The maximum power dissipation point obtained must not be greater than the power dissipation that results from Equation 2:

$$P_{DMAX} = (T_{JMAX} - T_A) / \theta_{JA} \quad (2)$$

For package MUA08A,  $\theta_{JA} = 210^\circ\text{C/W}$ .  $T_{JMAX} = 150^\circ\text{C}$  for the HWD2108. Depending on the ambient temperature,  $T_A$  of the system surroundings, Equation 2 can be used to find the maximum internal power dissipation supported by the IC packaging. If the result of Equation 1 is greater than that of Equation 2, then either the supply voltage must be decreased, the load impedance increased or  $T_A$  reduced. For the typical application of a 5V power supply, with a 32Ω load, the maximum ambient temperature possible without violating the maximum junction temperature is approximately 133.2°C provided that device operation is around the maximum power dissipation point. Power dissipation is a function of output power and thus, if typical operation is not around the maximum power dissipation point, the ambient temperature may be increased accordingly. Refer to the **Typical Performance Characteristics** curves for power dissipation information for lower output powers.

### POWER SUPPLY BYPASSING

As with any power amplifier, proper supply bypassing is critical for low noise performance and high power supply rejection. Applications that employ a 5V regulator typically use a 10μF in parallel with a 0.1μF filter capacitors to stabilize the regulator's output, reduce noise on the supply line, and improve the supply's transient response. However, their presence does not eliminate the need for a local 0.1μF supply bypass capacitor,  $C_S$ , connected between the HWD2108's supply pins and ground. Keep the length of leads and traces that connect capacitors between the HWD2108's power supply pin and ground as short as possible. Connecting a 1.0μF capacitor,  $C_B$ , between the IN A(+) / IN B(+) node and ground improves the internal bias voltage's stability and improves the amplifier's PSRR. The PSRR improvements increase as the bypass pin capacitor value increases. Too large, however, increases the amplifier's turn-on time. The selection of bypass capacitor values, especially  $C_B$ , depends on desired PSRR requirements, click and pop performance (as explained in the section, **Selecting Proper External Components**), system cost, and size constraints.

### SELECTING PROPER EXTERNAL COMPONENTS

Optimizing the HWD2108's performance requires properly selecting external components. Though the HWD2108 operates well when using external components with wide tolerances, best performance is achieved by optimizing component values.

The HWD2108 is unity-gain stable, giving a designer maximum design flexibility. The gain should be set to no more than a given application requires. This allows the amplifier to achieve minimum THD+N and maximum signal-to-noise ratio. These parameters are compromised as the closed-loop gain increases. However, low gain demands input signals with greater voltage swings to achieve maximum output power. Fortunately, many signal sources such as audio CODECs have outputs of  $1V_{RMS}$  (2.83 $V_{P-P}$ ). Please refer to the **Audio Power Amplifier Design** section for more information on selecting the proper gain.

### Input and Output Capacitor Value Selection

Amplifying the lowest audio frequencies requires high value input and output coupling capacitors ( $C_I$  and  $C_O$  in *Figure 1*). A high value capacitor can be expensive and may compromise space efficiency in portable designs. In many cases, however, the speakers used in portable systems, whether internal or external, have little ability to reproduce signals below 150Hz. Applications using speakers with this limited frequency response reap little improvement by using high value input and output capacitors.

Besides affecting system cost and size,  $C_I$  has an effect on the HWD2108's click and pop performance. The magnitude of the pop is directly proportional to the input capacitor's size. Thus, pops can be minimized by selecting an input capacitor value that is no higher than necessary to meet the desired -3dB frequency.

As shown in *Figure 1*, the input resistor,  $R_I$  and the input capacitor,  $C_I$ , produce a -3dB high pass filter cutoff frequency that is found using Equation (3). In addition, the output load  $R_L$ , and the output capacitor  $C_O$ , produce a -3dB high pass filter cutoff frequency defined by Equation (4).

$$f_{I-3db} = 1/2\pi R_I C_I \quad (3)$$

$$f_{O-3db} = 1/2\pi R_L C_O \quad (4)$$

## Application Information (Continued)

Also, careful consideration must be taken in selecting a certain type of capacitor to be used in the system. Different types of capacitors (tantalum, electrolytic, ceramic) have unique performance characteristics and may affect overall system performance.

### Bypass Capacitor Value

Besides minimizing the input capacitor size, careful consideration should be paid to the value of the bypass capacitor,  $C_B$ . Since  $C_B$  determines how fast the HWD2108 settles to quiescent operation, its value is critical when minimizing turn-on pops. The slower the HWD2108's outputs ramp to their quiescent DC voltage (nominally  $1/2 V_{DD}$ ), the smaller the turn-on pop. Choosing  $C_B$  equal to  $1.0\mu\text{F}$  or larger, will minimize turn-on pops. As discussed above, choosing  $C_i$  no larger than necessary for the desired bandwidth helps minimize clicks and pops.

## AUDIO POWER AMPLIFIER DESIGN

### Design a Dual 70mW/32Ω Audio Amplifier

Given:

Power Output	70mW
Load Impedance	32Ω
Input Level	1Vrms (max)
Input Impedance	20kΩ
Bandwidth	100Hz–20kHz $\pm$ 0.50dB

The design begins by specifying the minimum supply voltage necessary to obtain the specified output power. One way to find the minimum supply voltage is to use the Output Power vs Supply Voltage curve in the **Typical Performance Characteristics** section. Another way, using Equation (5), is to calculate the peak output voltage necessary to achieve the desired output power for a given load impedance. To account for the amplifier's dropout voltage, two additional voltages, based on the Dropout Voltage vs Supply Voltage in the **Typical Performance Characteristics** curves, must be added to the result obtained by Equation (5). For a single-ended application, the result is Equation (6).

$$V_{\text{opeak}} = \sqrt{(2R_L P_O)} \quad (5)$$

$$V_{DD} \geq (2V_{\text{OPEAK}} + (V_{\text{ODTOP}} + V_{\text{ODBOT}})) \quad (6)$$

The Output Power vs Supply Voltage graph for a 32Ω load indicates a minimum supply voltage of 4.8V. This is easily met by the commonly used 5V supply voltage. The additional voltage creates the benefit of headroom, allowing the HWD2108 to produce peak output power in excess of 70mW without clipping or other audible distortion. The choice of supply voltage must also not create a situation that violates maximum power dissipation as explained above in the **Power Dissipation** section. Remember that the maximum power dissipation point from Equation (1) must be multiplied by two since there are two independent amplifiers inside the

package. Once the power dissipation equations have been addressed, the required gain can be determined from Equation (7).

$$A_V \geq \sqrt{(P_O R_L)} / (V_{IN}) = V_{\text{orms}} / V_{\text{inrms}} \quad (7)$$

Thus, a minimum gain of 1.497 allows the HWD2108 to reach full output swing and maintain low noise and THD+N performance. For this example, let  $A_V=1.5$ .

The amplifiers overall gain is set using the input ( $R_i$ ) and feedback ( $R_f$ ) resistors. With the desired input impedance set at 20kΩ, the feedback resistor is found using Equation (8).

$$A_V = R_f / R_i \quad (8)$$

The value of  $R_f$  is 30kΩ.

The last step in this design is setting the amplifier's -3db frequency bandwidth. To achieve the desired  $\pm 0.25\text{dB}$  pass band magnitude variation limit, the low frequency response must extend to at least one-fifth the lower bandwidth limit and the high frequency response must extend to at least five times the upper bandwidth limit. The gain variation for both response limits is 0.17dB, well within the  $\pm 0.25\text{dB}$  desired limit. The results are an

$$f_L = 100\text{Hz}/5 = 20\text{Hz} \quad (9)$$

and a

$$f_H = 20\text{kHz} * 5 = 100\text{kHz} \quad (10)$$

As stated in the **External Components** section, both  $R_f$  in conjunction with  $C_i$ , and  $C_o$  with  $R_L$ , create first order high-pass filters. Thus to obtain the desired low frequency response of 100Hz within  $\pm 0.5\text{dB}$ , both poles must be taken into consideration. The combination of two single order filters at the same frequency forms a second order response. This results in a signal which is down 0.34dB at five times away from the single order filter -3dB point. Thus, a frequency of 20Hz is used in the following equations to ensure that the response is better than 0.5dB down at 100Hz.

$$C_i \geq 1 / (2\pi * 20 \text{ k}\Omega * 20 \text{ Hz}) = 0.397\mu\text{F}; \text{ use } 0.39\mu\text{F}.$$

$$C_o \geq 1 / (2\pi * 32\Omega * 20 \text{ Hz}) = 249\mu\text{F}; \text{ use } 330\mu\text{F}.$$

The high frequency pole is determined by the product of the desired high frequency pole,  $f_H$ , and the closed-loop gain,  $A_V$ . With a closed-loop gain of 1.5 and  $f_H = 100\text{kHz}$ , the resulting GBWP = 150kHz which is much smaller than the HWD2108's GBWP of 900kHz. This figure displays that if a designer has a need to design an amplifier with a higher gain, the HWD2108 can still be used without running into bandwidth limitations.

# Demonstration Board Layout

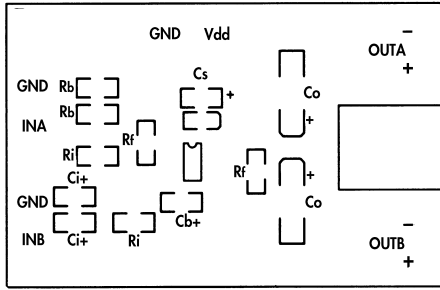

Recommended SO PC Board Layout:  
Top Silkscreen

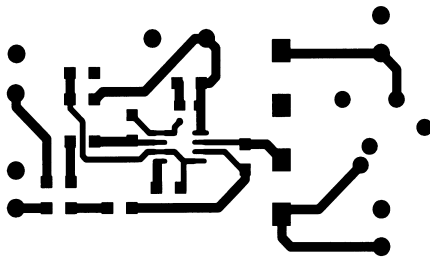

Recommended SOP PC Board Layout:  
Top Layer

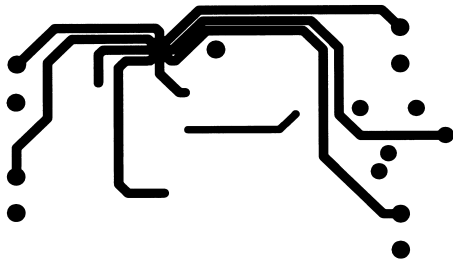

Recommended SOP PC Board Layout:  
Bottom Layer

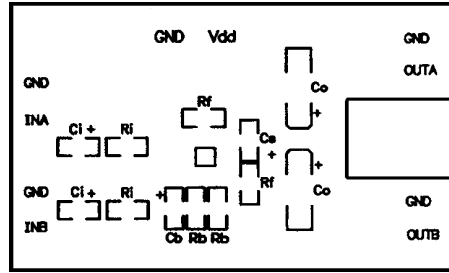

Recommended LD PC Board Layout:  
Top Silkscreen

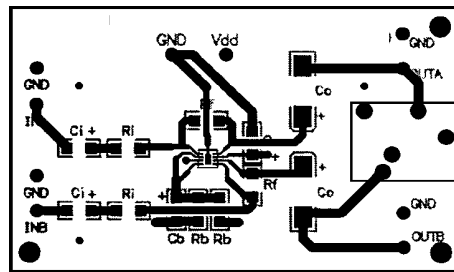

Recommended LD PC Board Layout:  
Top Layer

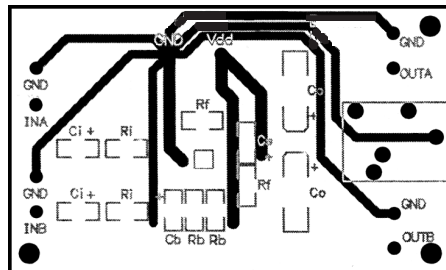

Recommended LD PC Board Layout:  
Bottom Layer

# Physical Dimensions inches (millimeters)

unless otherwise noted

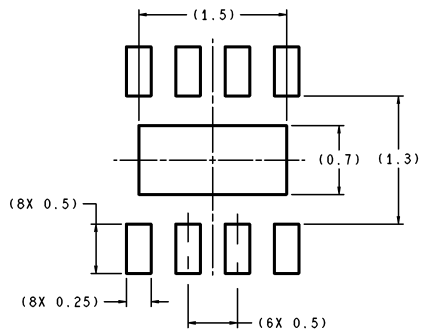

DIMENSIONS ARE IN MILLIMETERS

RECOMMENDED LAND PATTERN  
1:1 RATIO WITH PKG SOLDER PADS

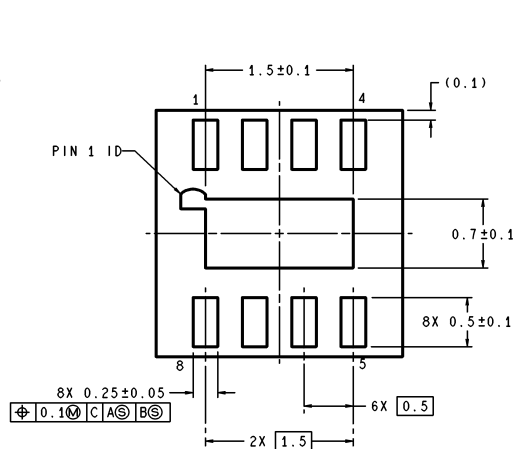
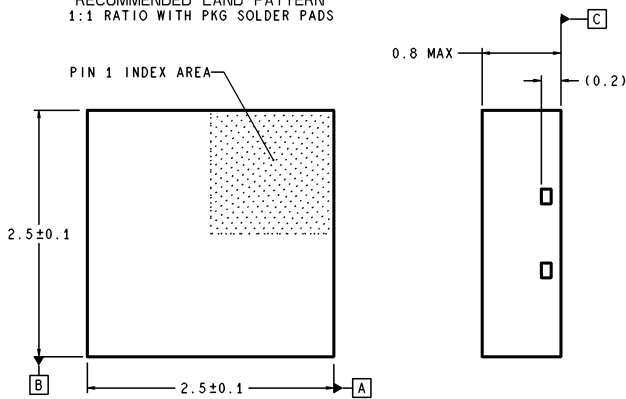

LDA08B (Rev A)

Order Number HWD2108LD

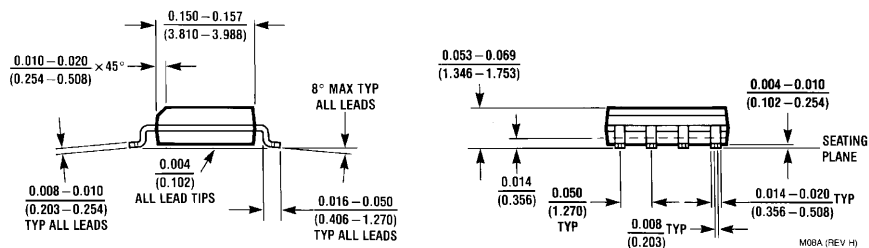
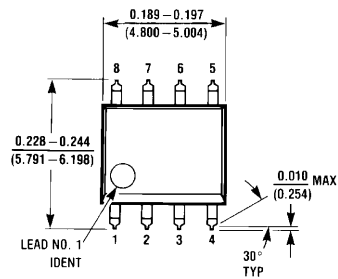

MOBA (REV H)

Order Number HWD2108M



**Physical Dimensions** inches (millimeters) unless otherwise noted (Continued)

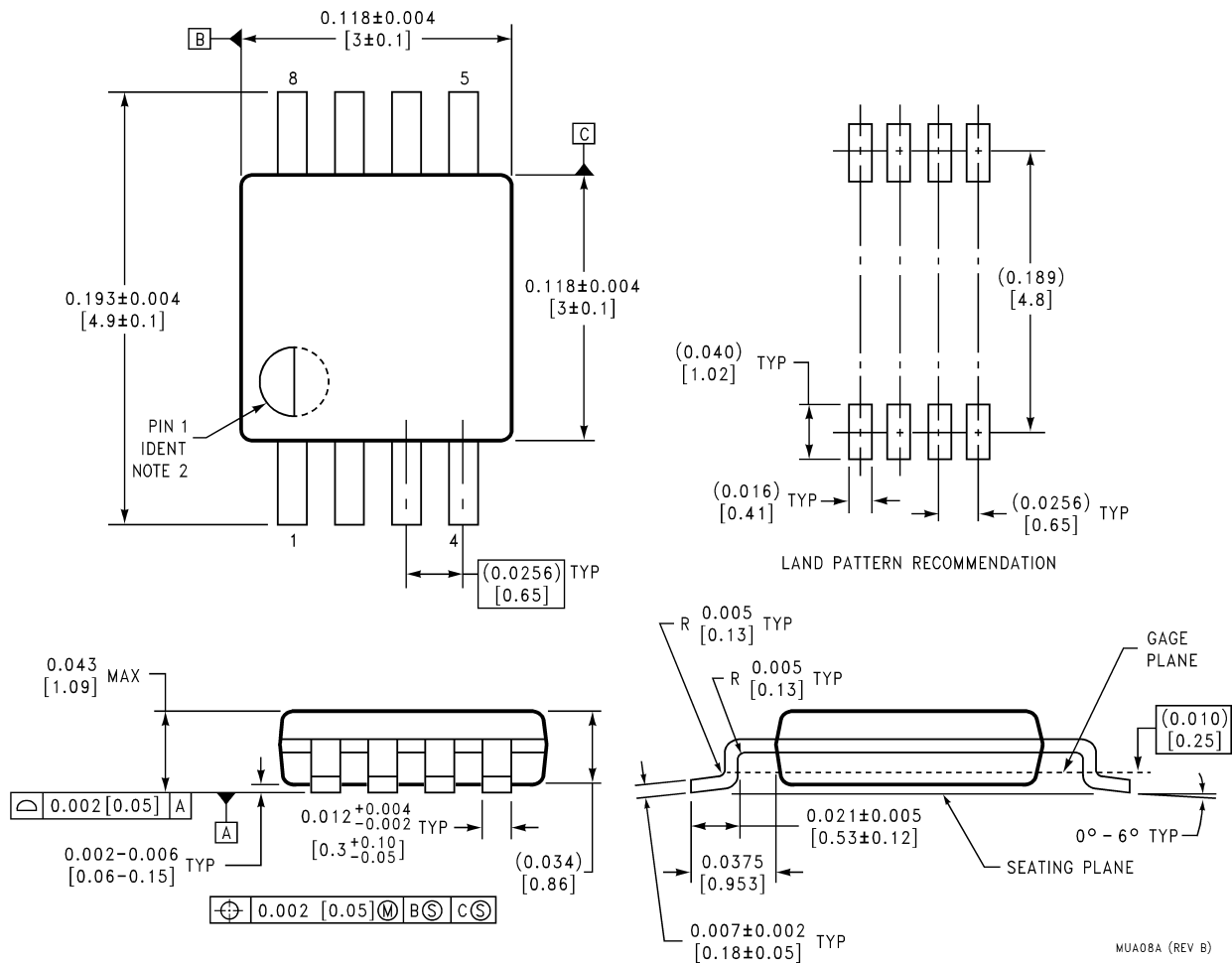

**Order Number HWD2108MM**

MUA08A (REV B)

---

Chengdu Sino Microelectronics System Co.,Ltd

([Http://www.csmsc.com](http://www.csmsc.com))



**Headquarters of CSMISC:**

Address: 2nd floor, Building D,  
Science & Technology  
Industrial Park, 11 Gaopeng  
Avenue, Chengdu High-Tech  
Zone, Chengdu City, Sichuan  
Province, P. R. China

PC: 610041

Tel: +86-28-8517-7737

Fax: +86-28-8517-5097

**Beijing Office:**

Address: Room 505, No. 6 Building,  
Zijin Garden, 68 Wanquanhe  
Rd., Haidian District,  
Beijing, P. R. China

PC: 100000

Tel: +86-10-8265-8662

Fax: +86-10-8265-86

**Shenzhen Office:**

Address: Room 1015, Building B,  
Zhongshen Garden,  
Caitian Rd, Futian District,  
Shenzhen, P. R. China

PC: 518000

Tel : +86-775-8299-5149

+86-775-8299-5147

+86-775-8299-6144

Fax: +86-775-8299-6142