

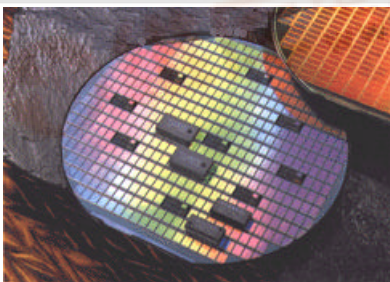

DRAM & SRAM Memory

HYUNDAI	
HY62256A-(I) Series	
32Kx8bit CMOS SRAM	
Description	Features
<p>The HY62256A/HY62256A-I is a high-speed, low power and 32,786 x 8-bits CMOS Static Random Access Memory fabricated using Hyundai's high performance CMOS process technology. The HY62256A/HY62256A-I has a data retention mode that guarantees data to remain valid at the minimum power supply voltage of 2.0 volt. Using the CMOS technology, supply voltages from 2.0 to 5.5 volt has little effect on supply current in the data retention mode. The HY62256A/HY62256A-I is suitable for use in low voltage operation and battery back-up application.</p>	<ul style="list-style-type: none"> ● Fully static operation and Tri-state outputs ● TTL compatible inputs and outputs ● Low power consumption -2.0V(min.) data retention ● Standard pin configuration <ul style="list-style-type: none"> -28 pin 600 mil PDIP -28 pin 330 mil SOP -28 pin 8x13.4 mm TSOP-1 (standard and reversed)

Product No.	Voltage (V)	Speed (ns)	Operation Current(mA)	Standby Current(uA)			Temperature (°C)
					L	LL	
HY62256A	5.0	55/70/85	50	1mA	100	25	0-70(Normal)
HY62256A-I	5.0	55/70/85	50	1mA	100	-	-40-85(E.T.)
Note 1. E T. Extended Temperature, Normal: Normal Temperature 2. Current value is max.							
Features Pins Ratings Timing Package Ordering							

3101 North First Street, San Jose, CA 95134
 Phone: 408-232-8000 URL: <http://www.hea.com/>

[SRAM Data Sheets](#) | [Memory Products](#) | [email: DRAMSRAMmemory@hea.com](mailto:DRAMSRAMmemory@hea.com)

Copyright © 1997 Hyundai Electronics America.



HYUNDAI ELECTRONICS AMERICA HY62256A-(I) Series 32Kx8bit CMOS SRAM	PIN INFORMATION
---	------------------------

PIN CONNECTION

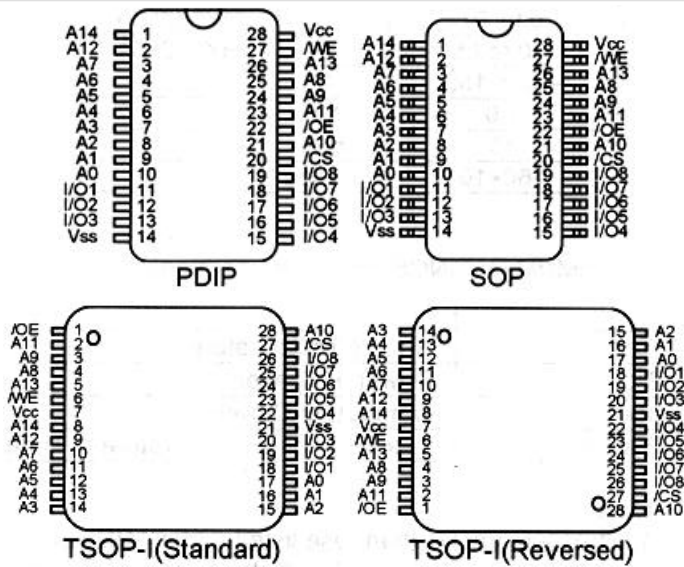

BLOCK DIAGRAM

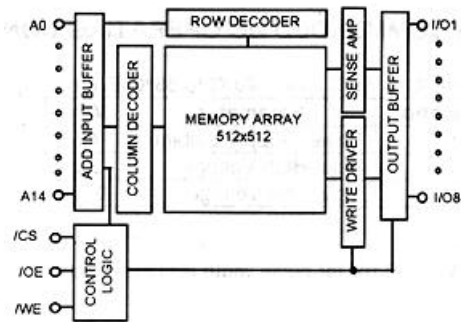

PIN DESCRIPTION	
Pin Name	Pin Function
/CS	Chip Select
/WE	Write Enable
/OE	Output Enable
A0-A14	Address Inputs
I/O1-I/O8	Data Input/Output
Vcc	Power(+5.0V)
Vss	Ground
Features Pins Ratings Timing Package Ordering	

Phone: 408-232-8000 URL: <http://www.hea.com/>

[SRAM Data Sheets](#) | [Memory Products](#) | [email: DRAMSRAMmemory@hea.com](mailto:DRAMSRAMmemory@hea.com)

Copyright © 1997 Hyundai Electronics America.



HYUNDAI ELECTRONICS AMERICA HY62256A-(I) Series 32Kx8bit CMOS SRAM	RATINGS INFORMATION
---	----------------------------

ABSOLUTE MAXIMUM RATING (1)				
Symbol	Parameter	Rating	Unit	Remark
V _{CC} V _{IN} V _{OUT}	Power Supply Input/Output Voltage	-0.5 to 7.0	V	
T _A	Operating Temperature	0 to 70	°C	HY62256A
		-40 to 85	°C	HY62256A-I
T _{STG}	Storage Temperature	-65 to 150	°C	
P _D	Power Dissipation	1.0	W	
I _{OUT}	Data OutPut Current	50	mA	
T _{SOLDER}	Lead Soldering Temperature & Time	260 /10	°C / sec	
Note 1. Stresses greater than those listed under ABSOLUTE MAXIMUM RATINGS may cause permanent damage to the device. This is stress rating only and the functional operation of the device under these or any other conditions above those indicated in the operation of this specification is not implied. Exposure to the absolute maximum rating conditions for extended period may affect reliability.				

RECOMMENDED DC OPERATING CONDITIONS					
T _A =0°C to 70°C / T _A = -40°C to 85°C (E.T.)					
Symbol	Parameter	Min	Typ	Max	Unit
V _{CC}	Power Supply Voltage	4.5	5.0	5.5	V
V _{IH}	Input High Voltage	2.2	-	V _{CC} +0.5	V
V _{IL}	Input Low Voltage	-0.5(1)	-	0.8	V
Note 1. V _{IL} = -3.0V for pulse width less than 30ns					

TRUTH TABLE				
/CS	/WE	/OE	MODE	I/O OPERATION
H	X	X	Standby	High-Z
L	H	H	Output Disabled	High-Z
L	H	L	Read	Data Out
L	L	X	Write	Data In

Note:
1. H= V_{IH} , L= V_{IL} , X=Don't Care

[Features](#) | [Pins](#) | [Ratings](#) | [Timing](#) | [Package](#) | [Ordering](#)

DC CHARACTERISTICS								
V _{CC} = 5V ±% T _A = 0°C to 70°C (Normal) / -40°C to 85°C (E.T.) unless otherwise specified								
Symbol	Parameter		Test Condition	Min	Typ	Max	Unit	
I _{LI}	Input Leakage Current		V _{SS} ≤ V _{IN} ≤ V _{CC}	-1	-	1	uA	
I _{LO}	Output Leakage Current		V _{SS} ≤ V _{OUT} ≤ V _{CC} /CS= V_{IH} or /OE= V_{IH} or /WE = V_{IL}	-1	-	1	uA	
I _{CC}	Operating Power Supply Current		/CS = V_{IL} , V _{IN} = V_{IH} or V_{IL} , I _{I/O} = 0mA	-	30	50	mA	
I _{CC1}	Average Operating Current		/CS = V_{IL} Min. Duty Cycle = 100%, I _{I/O} = 0mA	-	40	70	mA	
I _{SB}	TTL Standby Current (TTL Inputs)		/CS = V_{IH} V _{IN} = V_{IH} or V_{IL}	-	0.4	2	mA	
I _{SB1}	CMOS Standby Current (CMOS Input)	HY62256A	/CS ≥ V _{CC} - 0.2V		-	-	1	mA
			V _{IN} ≤ 0.2V or	L	-	2	100	uA
		HY62256A-I	V _{IN} ≥	LL	-	1	25	uA
			V _{CC} -0.2V		-	-	1	mA
			L	-	2	100	uA	
V _{OL}	Output Low Voltage		I _{OL} = 2.1 mA	-	-	0.4	V	
V _{OH}	Output High Voltage		I _{OH} = 1mA	2.4	-	-	V	

Note: Typical values are at V_{CC} = 5.0V T_A = 25°C

AC CHARACTERISTICS									
V _{cc} = 5V(±)10%, T _A = 0°C to 70°C (Normal)/ -40°C to 85°C (E.T.) unless otherwise specified.									
#	Symbol	Parameter	-55		-70		-85		Unit
			Min.	Max.	Min.	Max.	Min.	Max.	
READ CYCLE									
1	t _{RC}	Read Cycle Time	55	-	70	-	85	-	ns
2	t _{AA}	Address Access Time	-	55	-	70	-	85	ns
3	t _{ACS}	Chip Select Access Time	-	55	-	70	-	85	ns
4	t _{OE}	Output Enable to Output Valid	-	30	-	35	-	45	ns
5	t _{CLZ}	Chip Select to Output in Low Z	5	-	5	-	5	-	ns
6	t _{OLZ}	Output Enable to Output in Low Z	5	-	5	-	5	-	ns
7	t _{CHZ}	Chip Deselection to Output in High Z	0	20	0	30	0	30	ns
8	t _{OHZ}	Out Disable to Output in High Z	0	20	0	30	0	30	ns
9	t _{OH}	Output Hold from Address Change	5	-	5	-	5	-	ns
WRITE CYCLE									
10	t _{WC}	Write Cycle Time	55	-	70	-	85	-	ns
11	t _{CW}	Chip Selection to End of Write	50	-	65	-	75	-	ns
12	t _{AW}	Address Valid to End of Write	50	-	65	-	75	-	ns
13	t _{AS}	Address Set-up Time	0	-	0	-	0	-	ns
14	t _{WP}	Write Pulse Width	40	-	50	-	55	-	ns
15	t _{WR}	Write Recovery Time	0	-	0	-	0	-	ns
16	t _{WHZ}	Write to Output in High Z	0	20	0	30	0	30	ns
17	t _{DW}	Data to Write Time Overlap	25	-	35	-	40	-	ns
18	t _{DH}	Data Hold from Write Time	0	-	0	-	0	-	ns
19	t _{OW}	Output Active from End of Write	5	-	5	-	5	-	ns

AC TEST CONDITIONS		
T _A = 0°C to 70°C (Normal) / -40°C to 85°C (E.T.) unless otherwise specified.		
PARAMETER	VALUE	
Input Pulse Level	0.8V to 2.4V	
Input Rise and Fall Time	5ns	
Input and Output Timing Reference Levels	1.5V	
Output Load	70/85/100ns	CL = 100pF + 1TTL Load

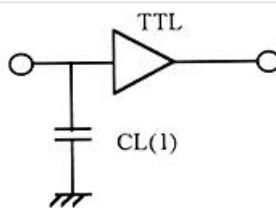
AC TEST LOADS

Note: Including jig and scope capacitance

CAPACITANCE

$T_{AA} = 25\text{ }^{\circ}\text{C}$, $f = 1.0\text{MHz}$

Symbol	Parameter	Condition	Max	Unit
C_{IN}	Input Capacitance	$V_{IN} = 0V$	6	pF
$C_{I/O}$	Input/Output Capacitance	$V_{I/O} = 0V$	8	pF

Note: These parameters are sampled and not 100% tested

[Features](#) | [Pins](#) | [Ratings](#) | [Timing](#) | [Package](#) | [Ordering](#)

3101 North First Street, San Jose, CA 95134
 Phone: 408-232-8000 URL: <http://www.hea.com/>

[SRAM Data Sheets](#) | [Memory Products](#) | [email: DRAMSRAMmemory@hea.com](mailto:DRAMSRAMmemory@hea.com)

Copyright © 1997 Hyundai Electronics America.



HYUNDAI ELECTRONICS AMERICA HY62256A-I 32K x 8bit CMOS SRAM	TIMING INFORMATION
--	---------------------------

TIMING DIAGRAM

READ CYCLE 1

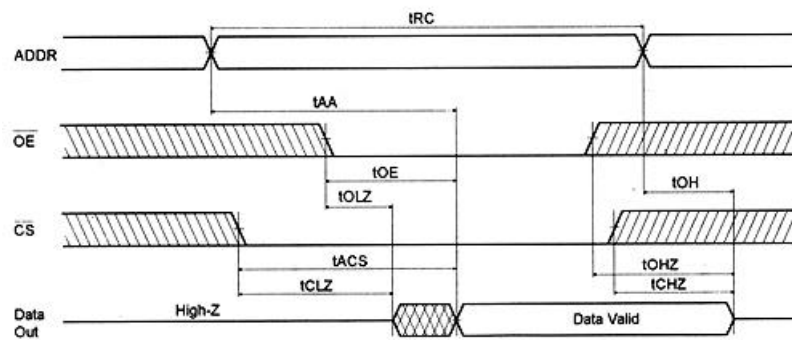

Note (READ CYCLE):

1. tCHZ and tOHZ are defined as the time at which the outputs achieve the open circuit conditions and are not referenced to output voltage levels.
2. At any given temperature and voltage condition, tCHZ max. is less than tCLZ min. both for a given device and from device to device.
3. /WE is high for the read cycle.

READ CYCLE 2

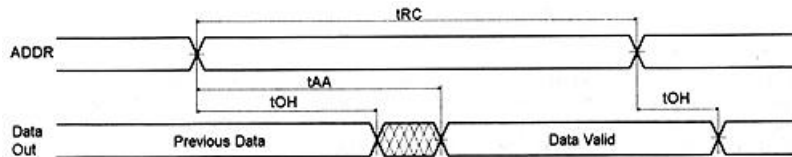

Note (READ CYCLE):

1. /WE is high for the read cycle.
2. Device is continuously selected /CS= VIL.
3. /OE =VIL.

WRITE CYCLE 1 (/OE Clocked)

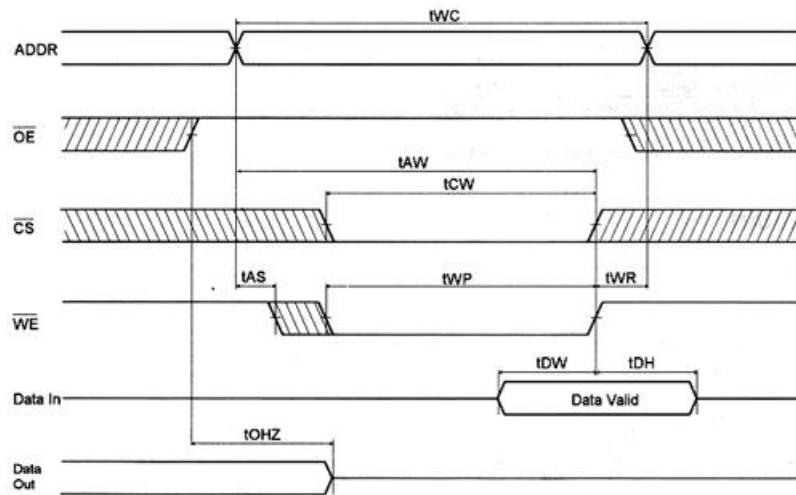

WRITE CYCLE 2 (/OE Low Fixed)

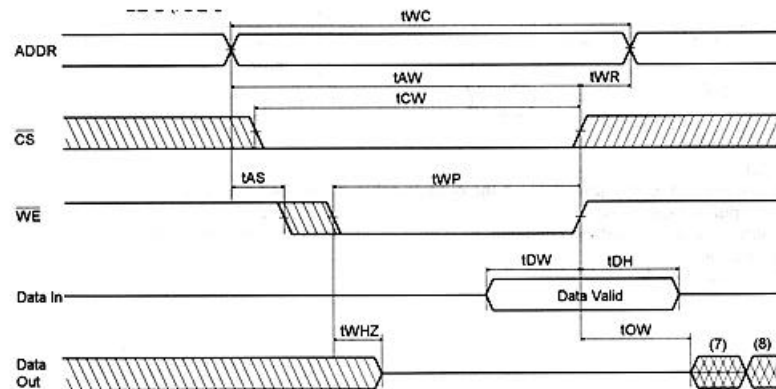

Notes (WRITE CYCLE):

1. A write occurs during the overlap of a low /CS and a low /WE. A write begins at the latest transition among /CS going low and /WE going low: A write ends at the earliest transition among /CS going high and /WE going high. tWP is measured from the beginning of write to the end of write.
2. tcw is measured from the later of /CS going low to the end of write .
3. tAS is measured from the address valid to the beginning of write.
4. tWR is measured from the end of write to the address change. tWR is applied in case a write ends as /CS, or /WE going high.
5. If /OE and /WE are in the read mode during this period, and the I/O pins are in the output low-Z state, input of opposite phase of the output must not be applied because bus contention can occur.
6. If /CS goes low simultaneously with /WE going low, or after /WE going low, the outputs remain in high impedance state.
7. DOUT is the same phase of latest written data in this write cycle.
8. DOUT is the read data of the new address.

DATA RETENTION CHARACTERISTIC								
T _A = 0°C to 70°C (normal) /-40°C to 85°C (E.T.)								
Symbol	Parameter		Test Condition	Min	Typ	Max	Unit	
V _{DR}	V _{cc} for Data Retention		/CS >= V _{cc} -0.2V V _{SS} <= V _{IN} <= V _{cc}	2	-	-	V	
I _{CCDR}	Data Retention Current	HY62256A	V _{cc} = 3.0V /CS >= V _{cc} -0.2V V _{SS} <= V _{IN} <= V _{cc}	L	-	1	50	uA
		HY62256A-1		LL	-	1	15(2)	uA
t _{CDR}	Chip Disable to Data Retention Time		See Data Retention Timing Diagram	0	-	-	ns	
t _R	Operating Recovery Time			t _{RC(3)}	-	-	ns	
Notes								
1. Typical values are under the condition of T _A = 25°C								
2. 3uA max. at T _A = 0°C to 40°C								
3. t _{RC} is read cycle time.								

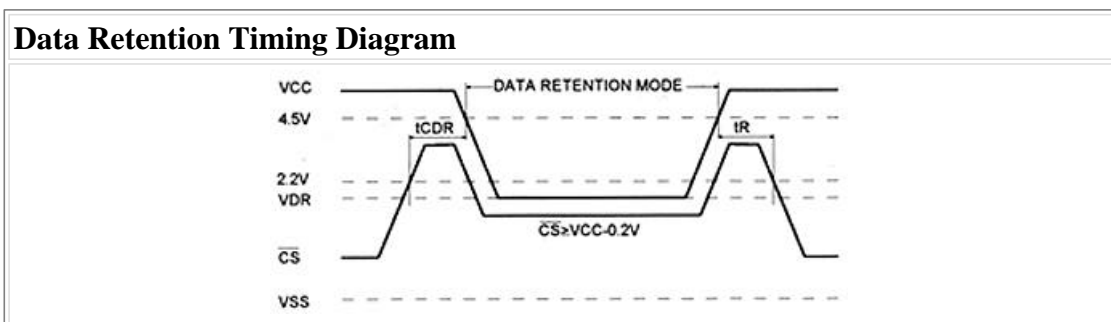

RELIABILITY SPEC.		
TEST MODE		TEST SPEC.
ESD	HBM	>= 2000V
	MM	>= 250V
LATCH-UP		<= -100mA
		>= 100mA
Features Pins Ratings Timing Package Ordering		

3101 North First Street, San Jose, CA 95134
 Phone: 408-232-8000 URL: <http://www.hea.com/>

[SRAM Data Sheets](#) | [Memory Products](#) | [email: DRAMSRAMmemory@hea.com](mailto:DRAMSRAMmemory@hea.com)

Copyright © 1997 Hyundai Electronics America.



HYUNDAI ELECTRONICS AMERICA
HY62256A-(I) Series
32Kx8bit CMOS SRAM

PACKAGE INFORMATION

28pin 600mil Dual In-Line Package(P)

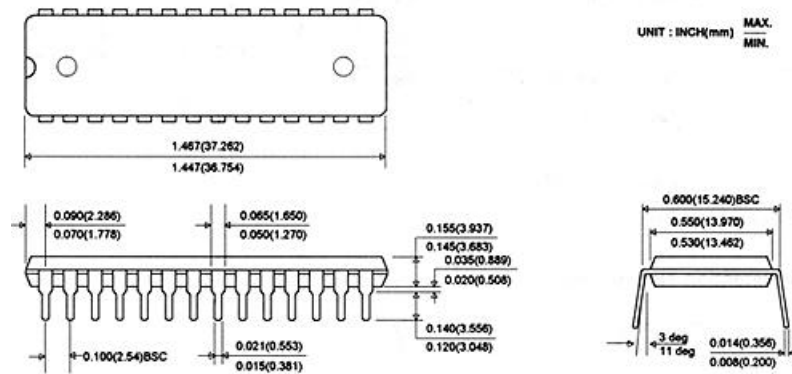

28pin 330mil Small Outline Package(J)

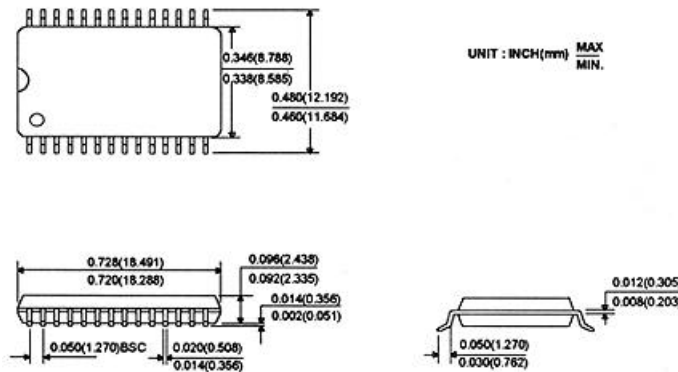

28pin 8X13.4mm Thin Small Outline Package Standard(T1)

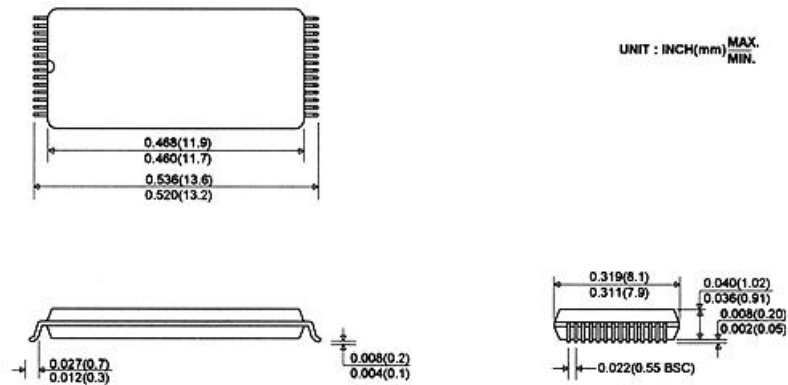

28pin 8x13.4mm Thin Small Outline Package Reversed(R1)

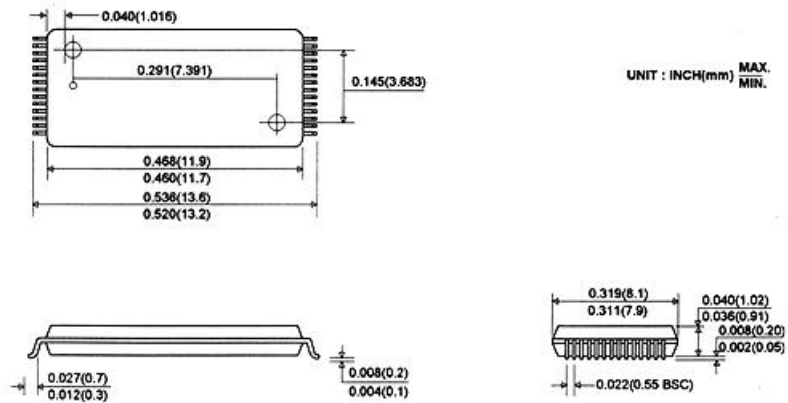

28pin 8X13.4mm Thin Small Outline Package SReversed(R1)

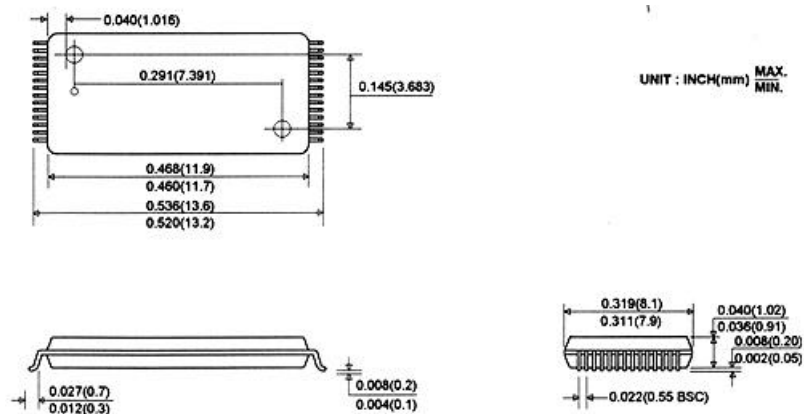

[Features](#) | [Pins](#) | [Ratings](#) | [Timing](#) | [Package](#) | [Ordering](#)

3101 North First Street, San Jose, CA 95134
Phone: 408-232-8000 URL: <http://www.hea.com/>

[SRAM Data Sheets](#) | [Memory Products](#) | [email: DRAMSRAMmemory@hea.com](mailto:DRAMSRAMmemory@hea.com)

Copyright © 1997 Hyundai Electronics America.



HYUNDAI ELECTRONICS AMERICA HY62256A-(I) Series 32Kx8bit CMOS SRAM	ORDERING INFORMATION
---	-----------------------------

Part No.	Speed	Power	Temp.	Package
HY62256AP	55/70/85			PDIP
HY62256ALP	55/70/85	L-part		PDIP
HY62256ALLP	55/70/85	LL-part		PDIP
HY62256AJ	55/70/85			SOP
HY62256ALJ	55/70/85	L-part		SOP
HY62256ALLJ	55/70/85	LL-part		SOP
HY62256AT1	55/70/85			TSOP-I Standard
HY62256ALT1	55/70/85	L-part		TSOP-I Standard
HY62256ALLT1	55/70/85	LL-part		TSOP-I Standard
HY62256AR1	55/70/85			TSOP-I Reversed
HY62256ALR1	55/70/85	L-part		TSOP-I Reversed
HY62256ALLR1	55/70/85	LL-part		TSOP-I Reversed
HY62256AP-I	55/70/85		E.T.	PDIP
HY62256ALP-I	55/70/85	L-part	E.T.	PDIP
HY62256AJ-I	55/70/85		E.T.	SOP
HY62256ALJ-I	55/70/85	L-part	E.T.	SOP
HY62256AT1-I	55/70/85		E .T.	TSOP-I
HY62256ALT1-I	55/70/85	L-part	E.T.	TSOP-I
HY62256AR2-I	55/70/85		E.T.	TSOP-I Reversed
HY62256ALR2-I	55/70/85	L-part	E.T.	TSOP-I Reversed
Features Pins Ratings Timing Package Ordering				

3101 North First Street, San Jose, CA 95134
 Phone: 408-232-8000 URL: <http://www.heacom/>

[SRAM Data Sheets](#) | [Memory Products](#) | [email: DRAMSRAMmemory@heacom.com](mailto:DRAMSRAMmemory@heacom.com)

Copyright © 1997 Hyundai Electronics America.