

The MRFIC Line General Purpose RF Cascode Amplifier

The MRFIC0916 is a cost-effective, high isolation cascode silicon monolithic amplifier in the industry standard SOT-143 surface mount package designed for general purpose RF applications. On chip bias circuitry sets the bias point while matching is accomplished off chip affording the maximum in application flexibility.

- Usable Frequency Range = 100 to 2500 MHz
- 18.5 dB typical gain at 850 MHz, $V_{CC} = 2.7$ Volts
- 2.3 dBm typical Output Power at 1 dB Gain Compression at 850 MHz, $V_{CC} = 2.7$ Volts
- 44 dB Typical Reverse Isolation at 850 MHz
- 5.6 mA Max Bias Current at $V_{CC} = 2.7$ Volts
- 2.7 to 5 Volt Supply
- Available in Tape and Reel by Adding T1 Suffix to Part Number.
T1 Suffix = 3,000 Units per 8 mm, 7 inch Reel.
- Device Marking = 16

MRFIC0916

SILICON GENERAL PURPOSE
RF CASCODE AMPLIFIER

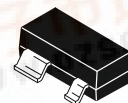

CASE 318A-05
(SOT-143)

MAXIMUM RATINGS ($T_A = 25^\circ\text{C}$ unless otherwise noted)

Rating	Symbol	Limit	Unit
Supply Voltage	V_{CC}	6	Vdc
RF Input Power	PRF	10	dBm
Power Dissipation	PDIS	100	mW
Supply Current	I_{CC}	20	mA
Thermal Resistance, Junction to Case	$R_{\theta JC}$	250	$^\circ\text{C}/\text{W}$
Storage Temperature Range	T_{stg}	-65 to +150	$^\circ\text{C}$
Operating Case Temperature	T_C	-35 to +100	$^\circ\text{C}$

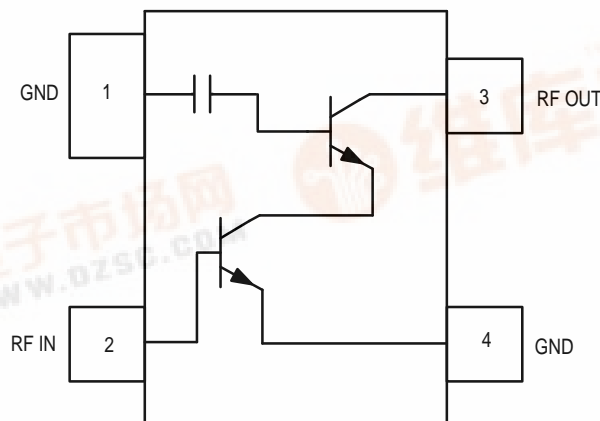

Pin Connections and Functional Block Diagram

RECOMMENDED OPERATING RANGES

Parameter	Symbol	Value	Unit
RF Frequency	f_{RF}	100 to 2500	MHz
Supply Voltage	V_{CC}	2.7 to 5	Vdc

ELECTRICAL CHARACTERISTICS ($V_{CC} = 2.7\text{ V}$, $T_A = 25^\circ\text{C}$, $f_{RF} = 850\text{ MHz}$, Tested in Circuit Shown in Figure 1)

Characteristic	Min	Typ	Max	Unit
Small Signal Gain	16.5	18.5	20.5	dB
Noise Figure	—	1.9	—	dB
Power Output at 1dB Gain Compression	0	2.3	—	dBm
Output 3rd Order Intercept Point	—	11	—	dBm
Reverse Isolation	—	44	—	dB
Supply Current	3.8	4.7	5.6	mA

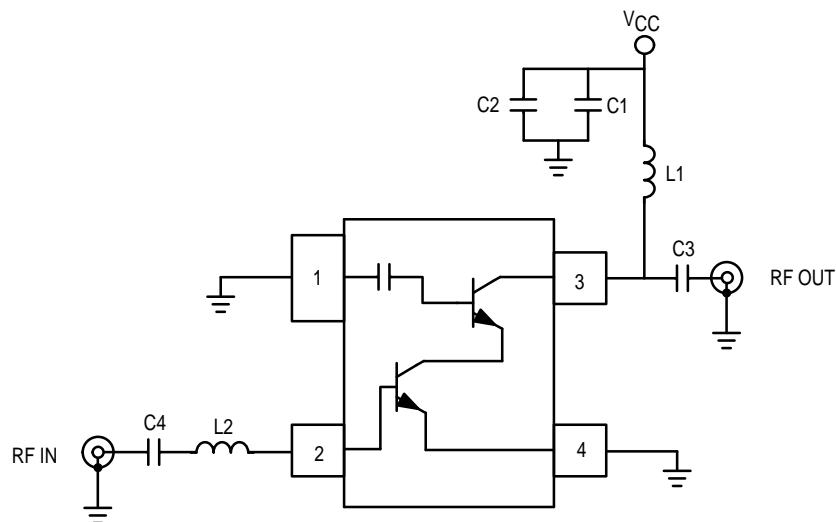

- C1 - 100 pF
- C2 - 0.01 μF
- C3 - 1.4 pF
- C4 - 100 pF
- L1 - 8.2 nH
- L2 - 6.8 nH

Figure 1. 850 MHz Applications Circuit Configuration

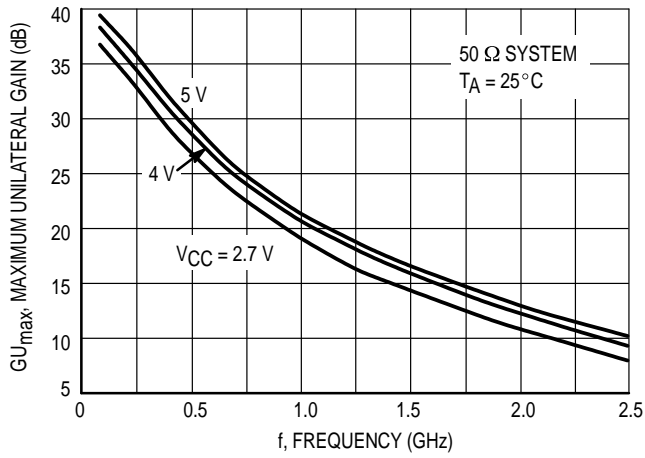

Figure 2. G_{Um} versus Frequency

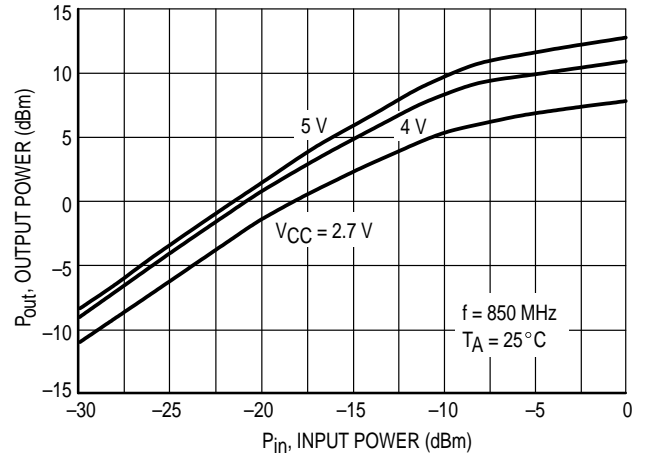

Figure 3. Output Power versus Input Power

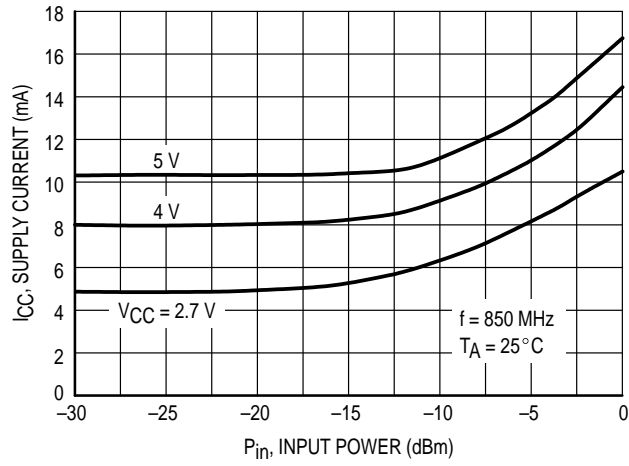

Figure 4. Supply Current versus Input Power

f (MHz)	S ₁₁		S ₂₁		S ₁₂		S ₂₂	
	S ₁₁	∠φ	S ₂₁	∠φ	S ₁₂	∠φ	S ₂₂	∠φ
100	0.806	-17.01	12.03	162.32	0.001	-0.14	0.956	-4.69
200	0.765	-33.28	11.18	145.74	0.001	71.58	0.948	-8.69
300	0.713	-47.99	10.18	130.99	0.002	69.67	0.945	-13.23
400	0.652	-61.35	9.06	118.01	0.003	64.61	0.930	-17.35
500	0.574	-70.94	8.06	106.50	0.003	62.93	0.904	-20.85
600	0.533	-81.00	7.09	96.50	0.003	61.94	0.891	-24.71
700	0.493	-89.33	6.36	87.60	0.003	63.16	0.875	-28.18
800	0.469	-97.65	5.62	79.57	0.003	66.33	0.857	-31.89
900	0.432	-103.64	5.16	72.38	0.002	80.79	0.845	-35.21
1000	0.409	-110.68	4.70	65.39	0.002	100.33	0.831	-38.86
1100	0.396	-116.17	4.29	58.75	0.002	127.72	0.815	-42.52
1200	0.383	-122.20	3.91	52.55	0.003	152.57	0.799	-45.77
1300	0.373	-126.00	3.66	46.34	0.004	164.39	0.789	-49.49
1400	0.369	-131.29	3.38	40.61	0.006	169.63	0.776	-53.23
1500	0.366	-134.46	3.14	35.29	0.008	172.81	0.762	-56.86
1600	0.366	-140.07	2.93	29.63	0.011	172.47	0.751	-60.74
1700	0.364	-143.07	2.75	23.86	0.013	172.79	0.738	-64.66
1800	0.368	-147.48	2.58	18.42	0.016	171.54	0.727	-68.29
1900	0.377	-148.91	2.42	13.15	0.020	170.15	0.719	-72.29
2000	0.381	-153.42	2.27	7.58	0.023	167.89	0.707	-76.58
2100	0.394	-155.23	2.15	2.46	0.027	165.86	0.695	-80.50
2200	0.396	-158.91	2.03	-3.00	0.032	163.46	0.685	-84.85
2300	0.416	-160.43	1.90	-8.32	0.037	161.00	0.672	-88.93
2400	0.424	-162.98	1.81	-13.30	0.042	158.00	0.662	-93.38
2500	0.434	-166.35	1.68	-18.45	0.047	155.58	0.654	-97.89

Table 1. Scattering Parameters (V_{CC} = 2.7 V, 50 Ω System)

f (MHz)	S ₁₁		S ₂₁		S ₁₂		S ₂₂	
	S ₁₁	∠φ	S ₂₁	∠φ	S ₁₂	∠φ	S ₂₂	∠φ
100	0.744	-17.43	16.979	160.38	0.001	-2.89	0.955	-4.40
200	0.691	-33.58	15.442	142.46	0.001	83.36	0.950	-8.33
300	0.627	-47.53	13.633	127.28	0.002	76.39	0.946	-12.79
400	0.558	-59.50	11.851	114.52	0.002	70.12	0.931	-16.75
500	0.482	-67.02	10.284	103.51	0.002	67.02	0.907	-20.11
600	0.440	-75.50	8.957	94.12	0.002	66.00	0.895	-23.85
700	0.401	-81.87	7.930	85.95	0.002	68.71	0.880	-27.22
800	0.377	-88.89	7.003	78.57	0.002	73.50	0.863	-30.83
900	0.348	-93.11	6.348	71.96	0.002	90.55	0.852	-34.06
1000	0.328	-98.88	5.747	65.59	0.002	113.74	0.838	-37.62
1100	0.317	-103.27	5.223	59.57	0.002	146.45	0.822	-41.18
1200	0.306	-108.54	4.765	53.98	0.003	165.49	0.808	-44.34
1300	0.301	-111.30	4.425	48.39	0.004	175.51	0.798	-47.95
1400	0.297	-116.30	4.082	43.18	0.006	177.46	0.785	-51.59
1500	0.298	-118.89	3.790	38.32	0.008	179.45	0.771	-55.11
1600	0.298	-124.58	3.531	33.13	0.011	178.69	0.760	-58.88
1700	0.301	-127.19	3.300	28.02	0.014	178.02	0.748	-62.66
1800	0.305	-131.73	3.093	23.10	0.016	176.25	0.737	-66.16
1900	0.319	-133.16	2.901	18.34	0.020	174.44	0.729	-70.03
2000	0.324	-137.94	2.724	13.33	0.023	172.03	0.717	-74.16
2100	0.339	-140.09	2.575	8.67	0.027	169.82	0.706	-77.92
2200	0.342	-143.98	2.434	3.79	0.032	166.99	0.696	-82.07
2300	0.367	-146.00	2.278	-0.98	0.036	164.37	0.684	-86.04
2400	0.375	-148.75	2.166	-5.56	0.042	161.35	0.674	-90.25
2500	0.387	-152.75	2.020	-10.12	0.046	158.69	0.666	-94.64

Table 2. Scattering Parameters (V_{CC} = 4 V, 50 Ω System)

f (MHz)	S ₁₁		S ₂₁		S ₁₂		S ₂₂	
	S ₁₁	∠φ	S ₂₁	∠φ	S ₁₂	∠φ	S ₂₂	∠φ
100	0.707	-17.56	20.04	159.03	0.001	-7.95	0.954	-4.25
200	0.648	-33.40	17.93	140.29	0.001	86.24	0.950	-8.15
300	0.579	-46.60	15.53	124.94	0.002	78.79	0.946	-12.54
400	0.509	-57.44	13.31	112.38	0.002	72.27	0.931	-16.42
500	0.438	-63.51	11.40	101.70	0.002	69.34	0.908	-19.68
600	0.397	-70.90	9.87	92.70	0.002	69.55	0.896	-23.35
700	0.363	-76.05	8.69	84.92	0.002	71.59	0.882	-26.64
800	0.340	-82.18	7.67	77.89	0.002	79.44	0.865	-30.20
900	0.316	-85.44	6.91	71.60	0.002	95.59	0.855	-33.36
1000	0.298	-90.52	6.24	65.56	0.001	121.55	0.841	-36.86
1100	0.290	-94.44	5.67	59.82	0.002	152.13	0.826	-40.37
1200	0.280	-99.17	5.17	54.53	0.003	169.84	0.811	-43.48
1300	0.277	-101.65	4.79	49.25	0.005	177.80	0.802	-47.02
1400	0.274	-106.49	4.42	44.27	0.006	-179.84	0.790	-50.59
1500	0.278	-109.07	4.10	39.65	0.008	-179.19	0.776	-54.04
1600	0.276	-114.88	3.82	34.68	0.011	-179.68	0.765	-57.73
1700	0.281	-117.46	3.56	29.88	0.013	179.47	0.753	-61.43
1800	0.285	-122.11	3.34	25.21	0.016	177.73	0.742	-64.85
1900	0.300	-123.94	3.14	20.70	0.019	175.80	0.734	-68.66
2000	0.305	-128.93	2.95	15.91	0.023	173.47	0.723	-72.71
2100	0.322	-131.48	2.78	11.50	0.027	171.04	0.712	-76.37
2200	0.324	-135.50	2.63	6.84	0.031	168.25	0.703	-80.42
2300	0.351	-138.04	2.47	2.33	0.036	165.47	0.691	-84.31
2400	0.358	-140.88	2.34	-2.05	0.041	162.71	0.681	-88.42
2500	0.371	-145.28	2.19	-6.40	0.046	160.19	0.674	-92.74

Table 3. Scattering Parameters (V_{CC} = 5 V, 50 Ω System)

PACKAGE DIMENSIONS

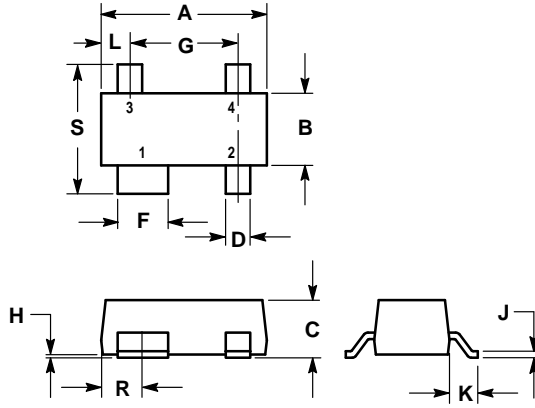

- NOTES:
 1. DIMENSIONING AND TOLERANCING PER ANSI Y14.5M, 1982.
 2. CONTROLLING DIMENSION: MILLIMETER.

DIM	MILLIMETERS		INCHES	
	MIN	MAX	MIN	MAX
A	2.80	3.04	0.110	0.120
B	1.20	1.39	0.047	0.055
C	0.84	1.14	0.033	0.045
D	0.39	0.50	0.015	0.020
F	0.79	0.93	0.031	0.037
G	1.78	2.03	0.070	0.080
H	0.013	0.10	0.0005	0.004
J	0.08	0.15	0.003	0.006
K	0.46	0.60	0.018	0.024
L	0.445	0.60	0.0175	0.024
R	0.72	0.83	0.028	0.033
S	2.11	2.48	0.083	0.098

**CASE 318A-05
ISSUE R**

Motorola reserves the right to make changes without further notice to any products herein. Motorola makes no warranty, representation or guarantee regarding the suitability of its products for any particular purpose, nor does Motorola assume any liability arising out of the application or use of any product or circuit, and specifically disclaims any and all liability, including without limitation consequential or incidental damages. "Typical" parameters which may be provided in Motorola data sheets and/or specifications can and do vary in different applications and actual performance may vary over time. All operating parameters, including "Typicals" must be validated for each customer application by customer's technical experts. Motorola does not convey any license under its patent rights nor the rights of others. Motorola products are not designed, intended, or authorized for use as components in systems intended for surgical implant into the body, or other applications intended to support or sustain life, or for any other application in which the failure of the Motorola product could create a situation where personal injury or death may occur. Should Buyer purchase or use Motorola products for any such unintended or unauthorized application, Buyer shall indemnify and hold Motorola and its officers, employees, subsidiaries, affiliates, and distributors harmless against all claims, costs, damages, and expenses, and reasonable attorney fees arising out of, directly or indirectly, any claim of personal injury or death associated with such unintended or unauthorized use, even if such claim alleges that Motorola was negligent regarding the design or manufacture of the part. Motorola and  are registered trademarks of Motorola, Inc. Motorola, Inc. is an Equal Opportunity/Affirmative Action Employer.

Mfax is a trademark of Motorola, Inc.

How to reach us:

USA/EUROPE/Locations Not Listed: Motorola Literature Distribution;
P.O. Box 5405, Denver, Colorado 80217. 303-675-2140 or 1-800-441-2447

JAPAN: Nippon Motorola Ltd.: SPD, Strategic Planning Office, 4-32-1,
Nishi-Gotanda, Shinagawa-ku, Tokyo 141, Japan. 81-3-5487-8488

Mfax™: RMFAX0@email.sps.mot.com – TOUCHTONE 602-244-6609
– US & Canada ONLY 1-800-774-1848

ASIA/PACIFIC: Motorola Semiconductors H.K. Ltd.; 8B Tai Ping Industrial Park,
51 Ting Kok Road, Tai Po, N.T., Hong Kong. 852-26629298

INTERNET: <http://motorola.com/sps>



MOTOROLA