



Data Sheet

MicroRAM™

Output Ripple Attenuation Module

Features

- >40dB ripple attenuation from 60Hz to 1MHz
- Integrated OR'ing diode supports N+1 redundancy
- Significantly improves load transient response
- Efficiency up to 98%
- User selectable performance optimization
- Combined active and passive filtering
- 3-30Vdc input range
- 20 and 30 Ampere ratings

Patents Pending

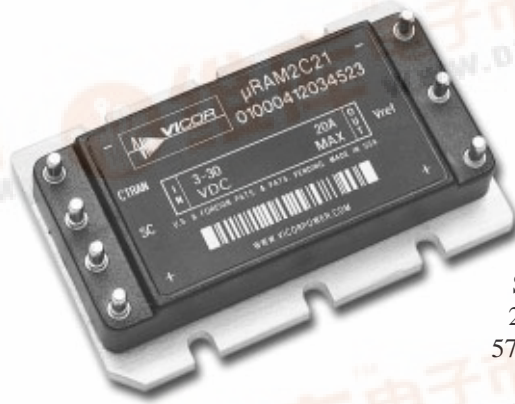

Shown actual size:
2.28 x 1.45 x 0.5 in
57,9 x 36,8 x 12,7 mm

Product Highlights

Vicor's MicroRAM output ripple attenuation module combines both active and passive filtering to achieve greater than 40dB of noise attenuation from 60Hz to 1Mhz. The MicroRAM operates over a range of 3 to 30Vdc, is available in either 20 or 30A models and is compatible with most manufacturers switching converters including Vicor's 1st and 2nd Generation DC-DC converters.

The MicroRAM's closed loop architecture greatly improves load transient response and with dual mode control, insures precise point of load voltage regulation, The MicroRAM supports redundant and parallel operation with its integrated OR'ing diode function.

It is available in Vicor's standard micro package (quarter brick) with a variety of terminations for through hole, socket or surface mount applications.

Absolute Maximum Ratings

Parameter	Rating	Unit	Notes
+In to -In	30	Vdc	Continuous
+In to -In	40	Vdc	100ms
Load current	40	Adc	Continuous
Ripple Input (Vp-p)	100	mV	60Hzc100 kHz
Ripple Input (Vp-p)	500	mV	100kHz-2MHz
Mounting torque	4-6 (0.45-0.68)	In. lbs (Nm)	6 each, 4-40 screw
Pin soldering temperature	500 (260)	°F (°C)	5 sec; wave solder
Pin soldering temperature	750 (390)	°F (°C)	7 sec; wave solder
Storage temperature (C, T-Grade)	-40 to +125	°C	
Storage temperature (H-Grade)	-55 to +125	°C	
Storage temperature (M-Grade)	-65 to +125	°C	
Operating temperature (C-Grade)	-20 to +100	°C	Baseplate
Operating temperature (T, H-Grade)	-40 to +100	°C	Baseplate
Operating temperature (M-Grade)	-55 to +100	°C	Baseplate

Thermal Resistance

Parameter	Typ	Unit
Baseplate to sink; flat, greased surface	0.16	°C/Watt
Baseplate to sink; with thermal pad (P/N 20264)	0.14	°C/Watt
Baseplate to ambient	8.0	°C/Watt
Baseplate to ambient; 1000 LFM	1.9	°C/Watt

Part Numbering

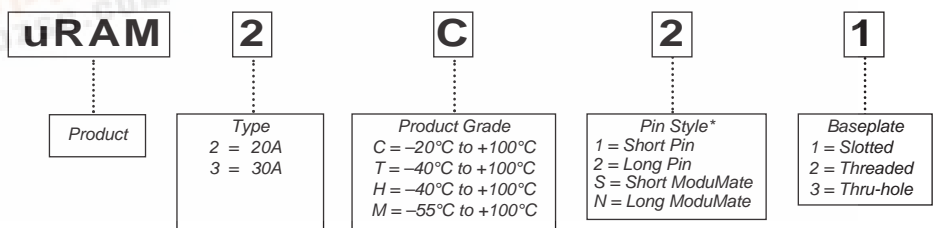

*Pin styles S & N are compatible with the ModuMate interconnect system for socketing and surface mounting.



PRELIMINARY

Electrical Characteristics

Electrical characteristics apply over the full operating range of input voltage, output power and baseplate temperature, unless otherwise specified. All temperatures refer to the operating temperature at the center of the baseplate.

■ μ RAM MODULE SPECIFICATIONS (-20°C to +100°C baseplate temperature)

Parameter	Min	Typ	Max	Unit	Notes
Operating current range					No internal current limiting. Converter input must be properly fused such that the μ RAM output current does not exceed the maximum operating current rating by more than 30% under a steady state condition.
μ RAM2xxx	0.02		20	A	
μ RAM3xxx	0.02		30	A	
Operating input voltage	3.0		30	Vdc	Continuous
Transient output response Load current step <1A/ μ sec			50	mVp-p	Step load change; see Figures 9, 12, & 15, pp. 6-7
Transient output response Load current step <1A/ μ sec (C _{TRAN} = 820 μ F)			50	mVp-p	Optional capacitance C _{TRAN} can be used to increase transient current capability; See Figures 1 & 2 on p. 3 and Figures 10, 13, & 16 on pp. 6-7
V _{HR} headroom voltage range ⁽¹⁾ @ 1A load	325		425	mV	See Figures 5, 6 & 7 See Table 1 for headroom setting resistor values
Output ripple Input V _{p-p} = 100mV			10 5	mVp-p mVrms	Ripple frequency 60Hz to 100kHz; optional capacitor C _{HR} = 100 μ F required to increase low frequency attenuation as shown in Figures 3a and 3b see Figures 8, 11, & 14, pp. 6-7
Output ripple Input V _{p-p} = 500mV			10 5	mVp-p mVrms	Ripple frequency 100kHz to 2MHz; see Figures 8, 11, & 14, pp. 6-7
SC output voltage ⁽²⁾	1.23			Vdc	See Table 1 R _{sc} value
OR'ing threshold		10		mV	V _{in} – V _{out}
μ RAM bias current			60	mA	
Power Dissipation					
μ RAM2xxx V _{HR} = 380mV@1A		7.5		W	V _{in} = 28V; I _{out} = 20A
μ RAM3xxx V _{HR} = 380mV@1A		11.5		W	V _{in} = 28V; I _{out} = 30A

⁽¹⁾ Headroom is the voltage difference between the +Input and +Output pins.

$$R_{HR} = (\mu\text{RAM } +\text{Out}/V_{HR}) \times 2.3k \text{ (see Table 1 for example values)}$$

⁽²⁾ SC resistor is required to trim the converter output up to accommodate the headroom of the μ RAM module when remote sense is not used. This feature can only be used when the trim reference of the converter is in the 1.21 to 1.25 Volt range.

(see Table 1 with calculated R_{sc} resistor values)

$$R_{sc} = ((\mu\text{RAM } +\text{Out})/1.23V \times 1k) - 2k$$

μ RAM Out	V _{HR} @ 1A	R _{HR} Value (ohms)	R _{sc} Value (ohms)
3.0V	375mV	18.4k	0.439k
5.0V	375mV	30.6k	2.07k
12.0V	375mV	73.6k	7.76k
15.0V	375mV	92.0k	10.20k
24.0V	375mV	147.2k	17.50k
28.0V	375mV	171.7k	20.76k

Table 1—R_{HR} and R_{sc} are computed values for a 375mV case. To compute different headroom voltages, or for standard resistor values and tolerances, use Notes 1 and 2.

PRELIMINARY

Electrical Characteristics (continued)

■ APPLICATION SCHEMATIC DRAWINGS USING VICOR CONVERTERS AND THE μ RAM

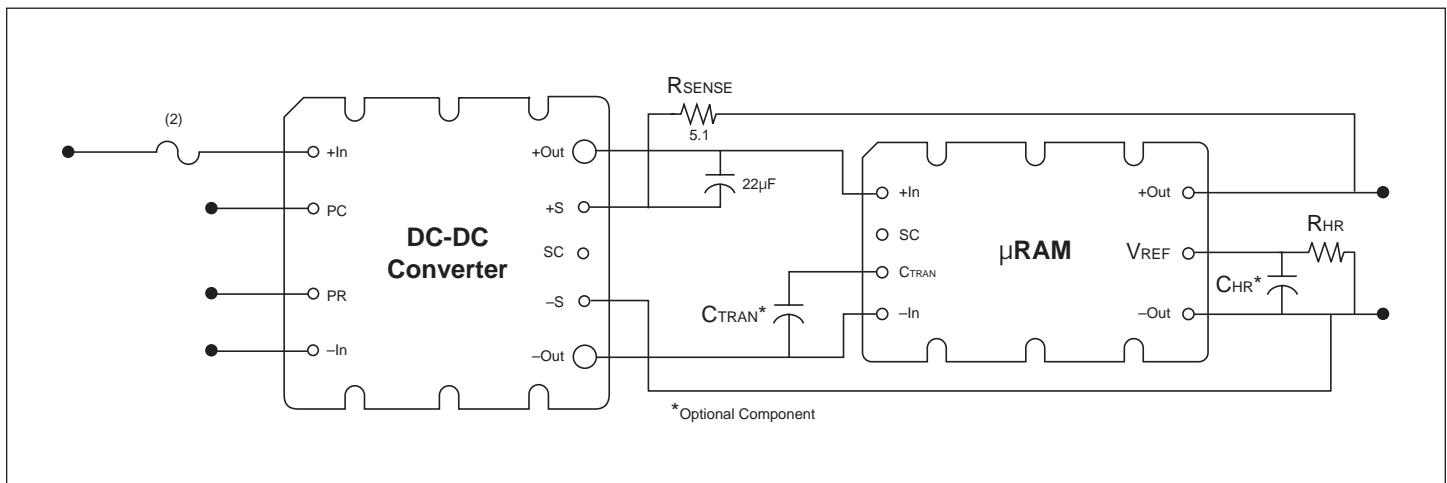

Figure 1—Typical Configuration using Remote Sensing

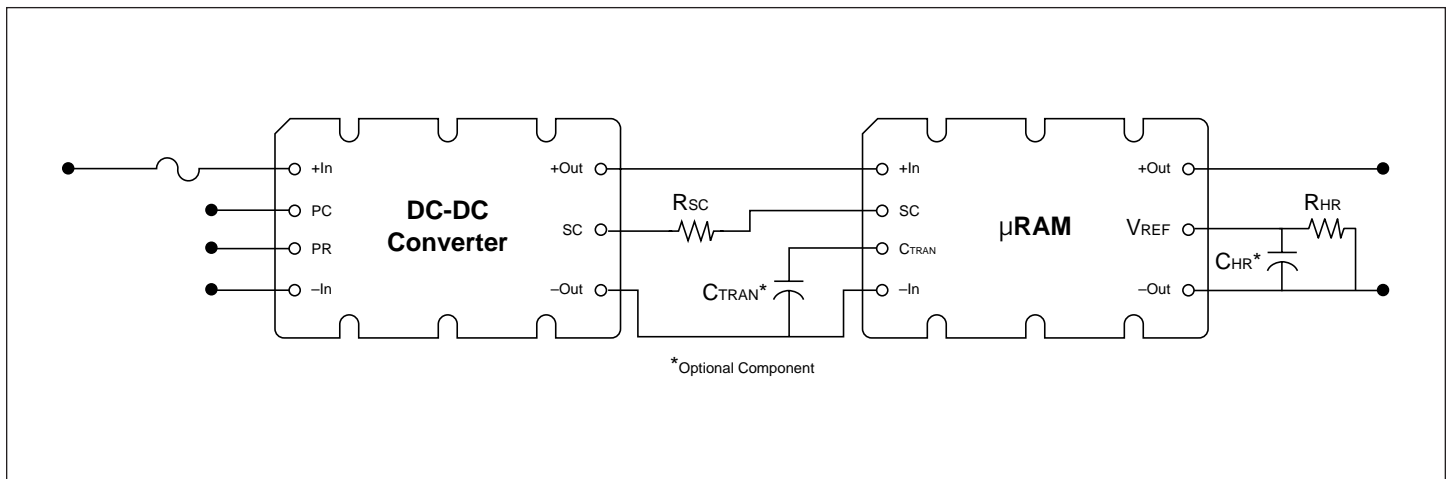

Figure 2—Typical Configuration using SC Control (Optional C_{HR} 25 μ F maximum in SC configuration.)

Functional Description

The MicroRAM has an internal passive filter that effectively attenuates ripple in the 50kHz to 1MHz range. An active filter provides attenuation from low frequency up to the 1MHz range. The user must set the headroom voltage of the active block with the external R_{HR} resistor to optimize performance. The MicroRAM must be connected as shown in Figures 1 or 2 depending on the load sensing method. The transient load current performance can be increased by the addition of optional C_{TRAN} capacitance to the C_{TRAN} pin. The low frequency ripple attenuation can be increased by addition of optional C_{HR} capacitance to the V_{REF} pin as shown in Figures 3a and 3b, on p. 5.

Transient load current is supplied by the internal C_{TRAN} capacitance, plus optional external capacitance, during the time it takes the converter loop to respond to the increase in load. The MicroRAM's active loop responds in roughly one microsecond to output voltage perturbations. There are limitations to the magnitude and the rate of change of the transient current that the MicroRAM can sustain while the converter responds. See Figures 8-16, on pp. 6 and 7, for examples of dynamic performance. A larger headroom voltage setting will provide increased transient performance, ripple attenuation and power dissipation while reducing overall efficiency (see Figures 4a, 4b, 4c and 4d on p. 5).

PRELIMINARY

Functional Description (continued)

The active loop senses the output current and reduces the headroom voltage in a linear fashion to approximate constant power dissipation of MicroRAM with increasing loads (see Figures 5, 6 & 7, p. 6). The headroom setting can be reduced to decrease power dissipation where the transient requirement is low and efficient ripple attenuation is the primary performance concern.

The active dynamic headroom range is limited on the low end by the initial headroom setting and the maximum expected load. If the maximum load in the application is 10 Amps, for example, the 1 Amp headroom can be set 75mV lower to conserve power and still have active headroom at the maximum load current of 10 Amps. The high end or maximum headroom range is limited by the internal OR'ing diode function.

The SC or trim-up function can be used when remote sensing is not available on the source converter or is not desirable. It is specifically designed for converters with a 1.23 Volt reference and a 1k ohm input impedance like Vicor 2nd Generation converters. In comparison to remote sensing, the SC configuration will have an error in the load voltage versus load current. It will be proportional to the

output current and the resistance of the load path from the output of the MicroRAM to the load.

The OR'ing feature prevents current flowing from the output of the MicroRAM back through it's input terminal in a redundant system configuration in the event that a converter output fails. When the converter output supplying the MicroRAM droops below the OR'ed output voltage potential of the redundant system, the input of the MicroRAM is isolated from it's output. Less than 50mA will flow out of the input terminal of the MicroRAM over the full range of input voltage under this condition.

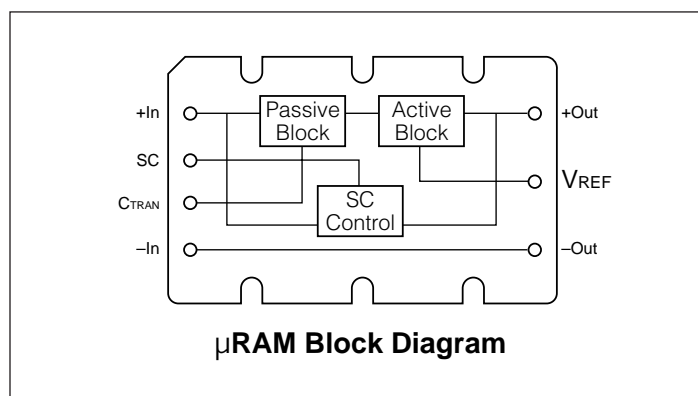

Application Notes

Load capacitance can affect the overall phase margin of the MicroRAM active loop as well as the phase margin of the converter loop. The distributed variables such as inductance of the load path, the capacitor type and value as well as its ESR and ESL also affect transient capability at the load. The following guidelines should be considered when point of load capacitance is used with the MicroRAM in order to maintain a minimum of 30 degrees of phase margin.

- 1) Using ceramic load capacitance with <1milliohm ESR and <1nH ESL:
 - (a) 20μF to 200μF requires 20nH of trace/wire load path inductance
 - (b) 200μF to 1,000μF requires 60nH of trace/wire load path inductance

- 2) For the case where load capacitance is connected directly to the output of the MicroRAM, i.e. no trace inductance, and the ESR is >1 milliohm:
 - (a) 20μF to 200μF load capacitance needs an ESL of >50nH
 - (b) 200μF to 1,000μF load capacitance needs an ESL of >5nH
- 3) Adding low ESR capacitance directly at the output terminals of MicroRAM is not recommended and may cause stability problems.
- 4) In practice the distributed board or wire inductance at a load or on a load board will be sufficient to isolate the output of the MicroRAM from any load capacitance and minimize any appreciable effect on phase margin.

PRELIMINARY

μRAM2xxx

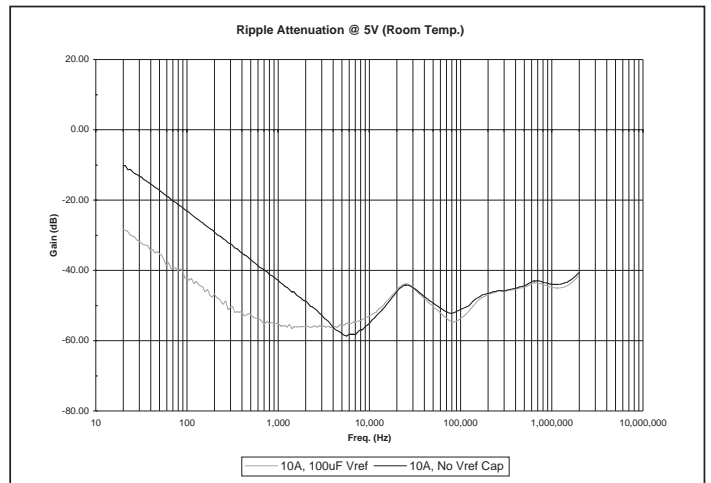
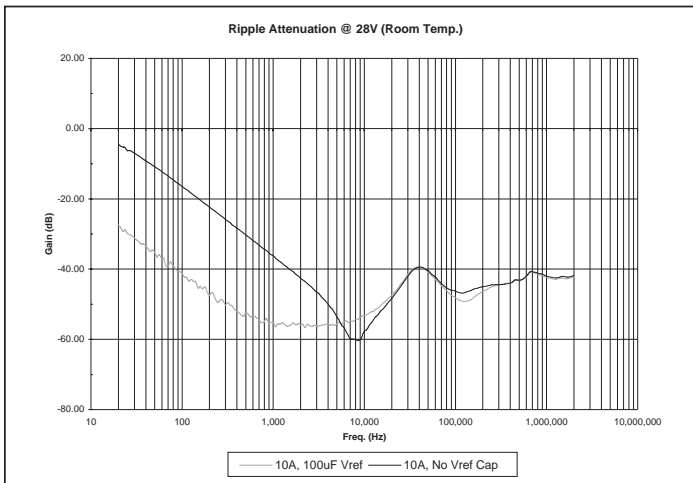

Figure 3a, 3b—Curves demonstrating the small signal attenuation performance as measured on a network analyzer with a typical module at (a) 28V and 10A output and (b) 5V and 10A. The low frequency attenuation can be enhanced by connecting a 100μF capacitor, CHR, to the VREF pin as shown in Figures 1 and 2.

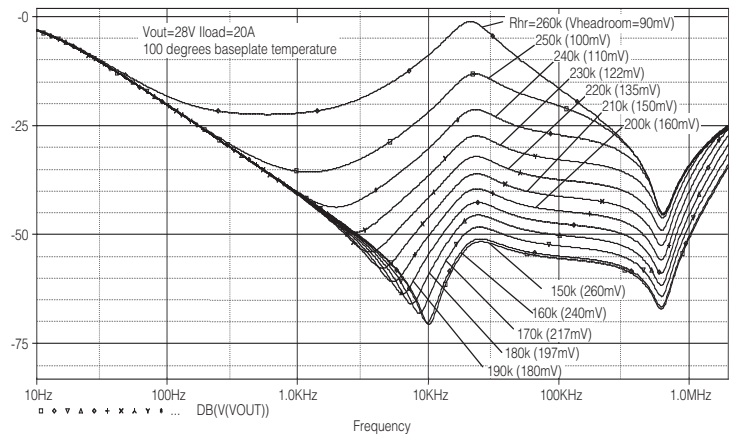
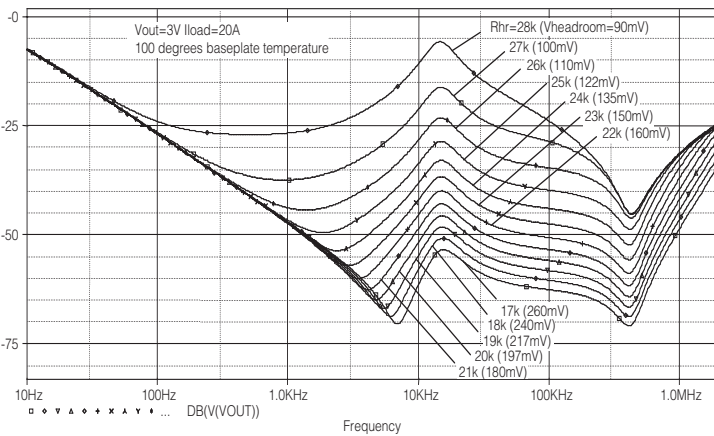

Figure 4a-4b—Simulated graphs demonstrating the tradeoff of attenuation versus headroom setting at 20 Amps and an equivalent 100°C baseplate temperature at 3V and 28V.

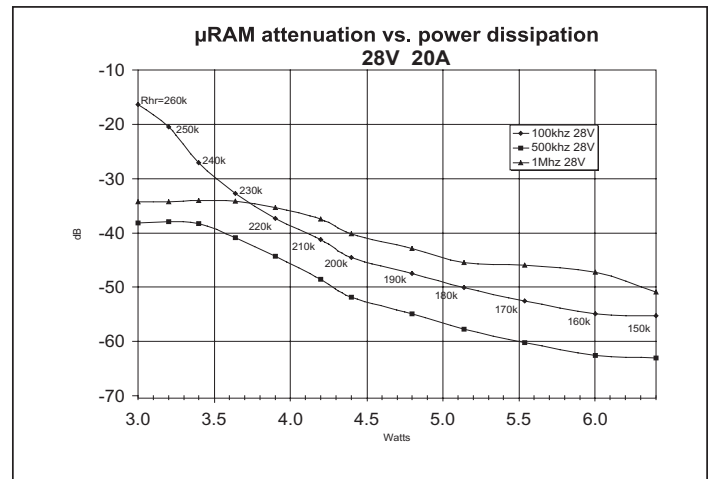
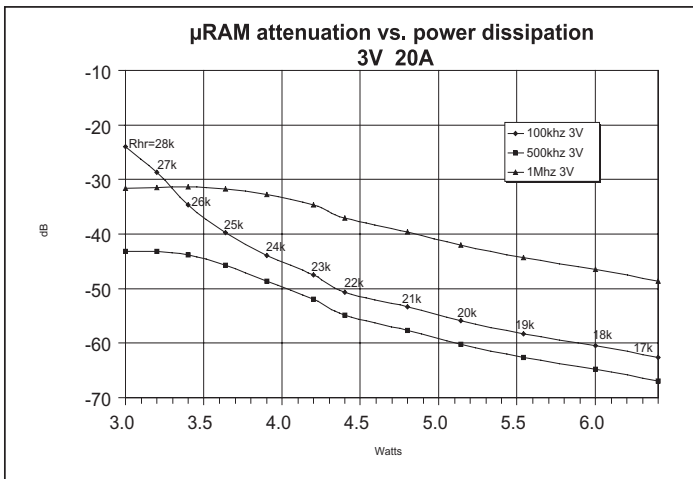

Figure 4c-4d—MicroRam attenuation vs. power dissipation at 3V 20A, and 28V 20A.

Notes:The measurements in Figures 8-16 were taken with a μRAM2C21 and standard scope probes with a 20MHz bandwidth scope setting. The criteria for transient current capability was as follows: The transient load current step was incremented from 10A to the peak value indicated, then stepped back to 10A until the resulting output peak to peak was around 40mV.

PRELIMINARY

μRAM2xxx (μRAM3xxx data not included in this rev.)

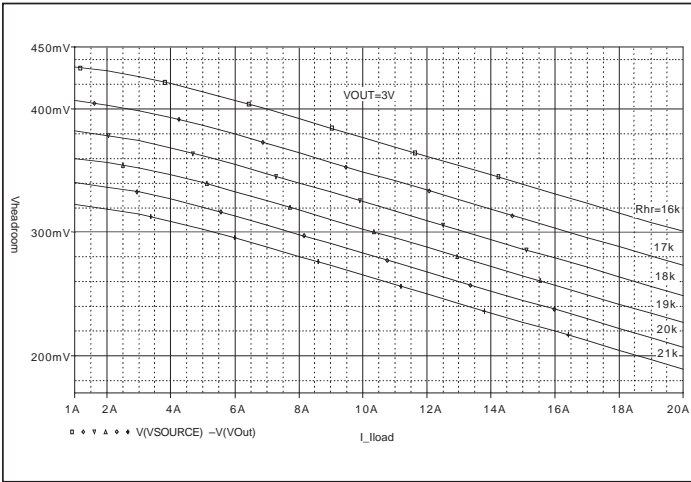

Figure 5—Headroom vs. load current at 3V output.

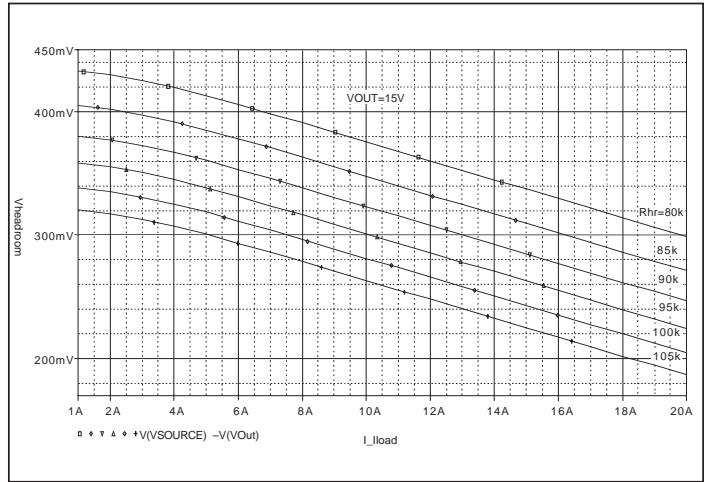

Figure 6—Headroom vs. load current at 15V output.

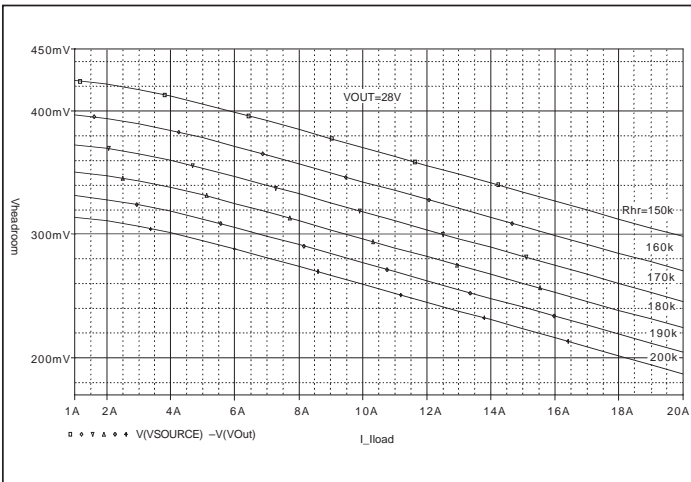

Figure 7—Headroom vs. load current at 28V output.

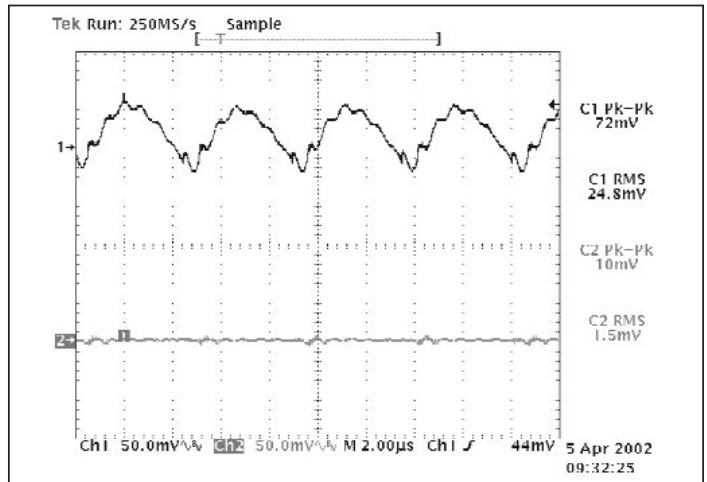

Figure 8—V375A28C600A and μRAM; Input and output ripple @ 50% (10A) load CH1=Vi; CH2=Vo; Vi-Vo=332mV; RHR=178k

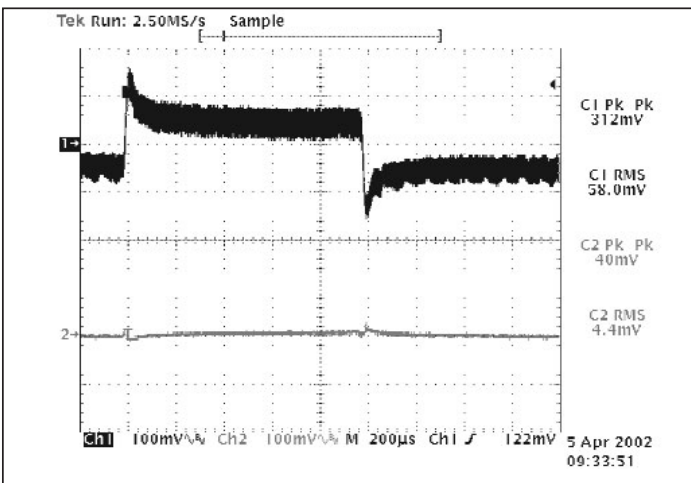

Figure 9—V375A28C600A and μRAM; Input and output dynamic response no added CTRAN; 20% of 20A rating load step of 4A (10A → 14A); RHR=178k (Configured as in Figs. 1 & 2)

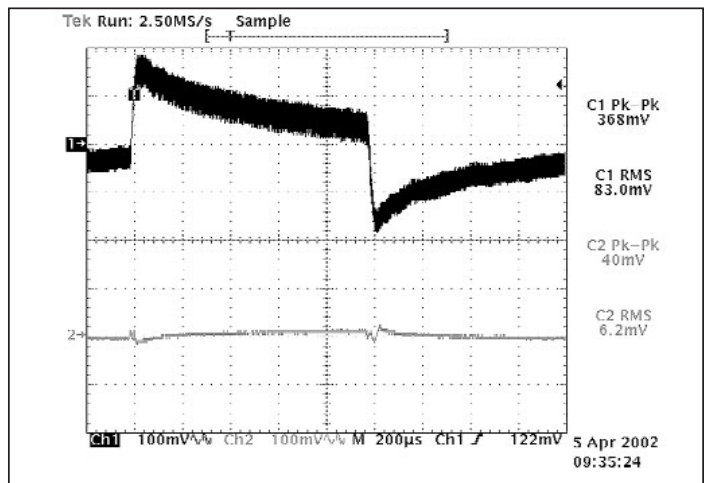

Figure 10—V375A28C600A and μRAM; Input and output dynamic response CTRAN=820μF Electrolytic; 32.5% of load step of 6.5A (10A → 16.5A); RHR=178k (Configured as in Figs. 1 & 2)

PRELIMINARY

μRAM2xxx

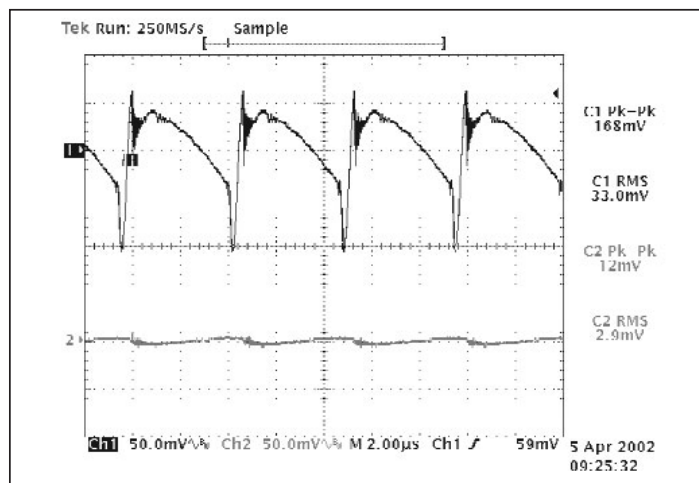

Figure 11—V375B12C250A and μRAM; Input and output ripple @50% (10A) load CH1=Vi; CH2=Vo; Vi-Vo=305mV; RHR=80k (Configured as in Figs. 1 & 2)

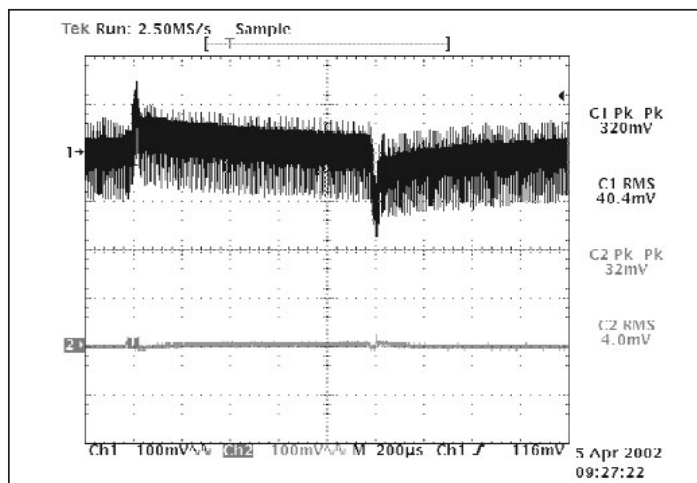

Figure 12—V300B12C250A and μRAM; Input and output dynamic response no added C_{TRAN}; 17.5% of 20A rating load step of 3.5A (10A →13.5A);RHR=80k (Configured as in Figs. 1 & 2)

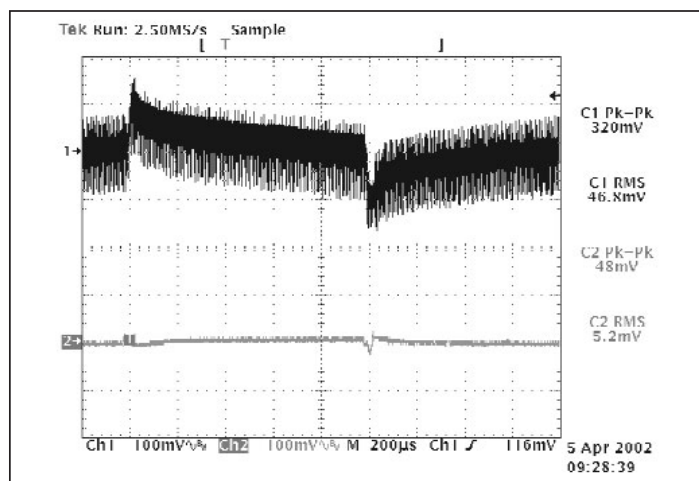

Figure 13—V300B12C250A and μRAM; Input and output dynamic response C_{TRAN}=820μF Electrolytic; 30% of load step of 6A (10A →16A);RHR=80k (Configured as in Figs. 1 & 2)

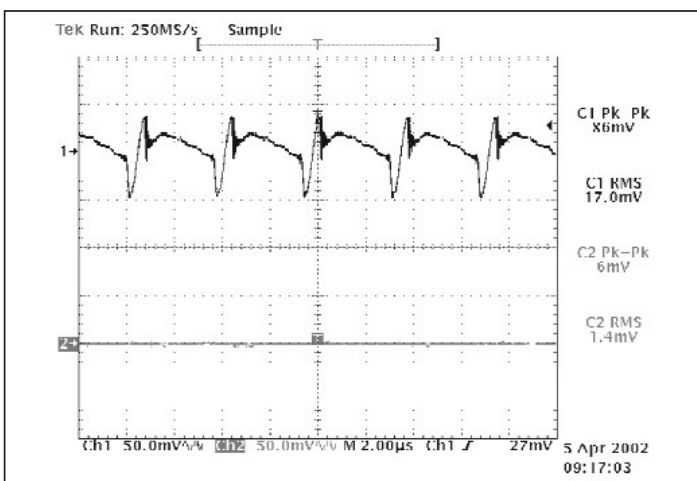

Figure 14—V48C5C100A and μRAM; Input and output ripple @50% (10A) load CH1=Vi; CH2=Vo; Vi-Vo=327mV; RHR=31k (Configured as in Figs. 1 & 2)

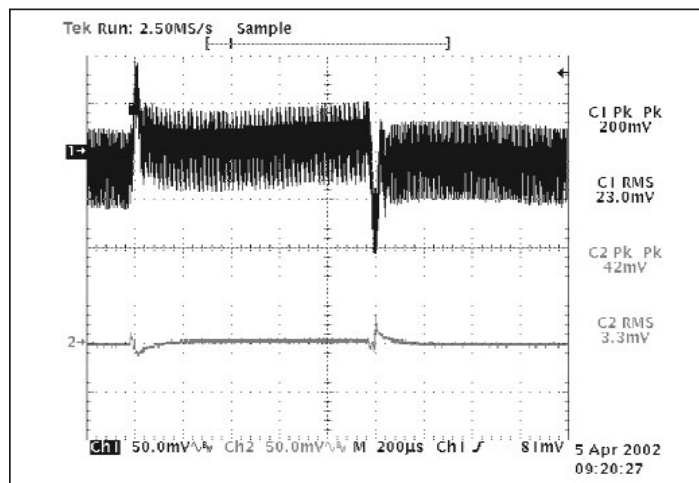

Figure 15—V48C5C100A and μRAM; Input and output dynamic response no added C_{TRAN}; 22.5% of 20A rating load step of 4.5A (10A →14.5A);RHR=31k (Configured as in Figs. 1 & 2)

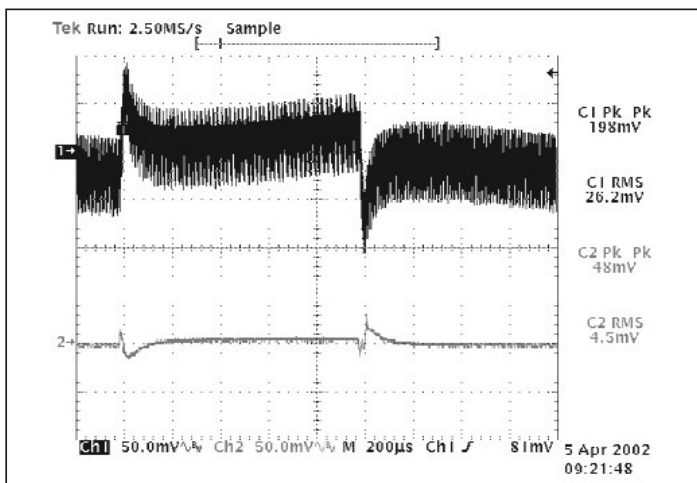

Figure 16—V48C5C100A and μRAM; Input and output dynamic response C_{TRAN}=820μF Electrolytic; 35% of load step of 7A (10A →17A);RHR=31k (Configured as in Figs. 1 & 2)

PRELIMINARY

Mechanical Drawings

MODULE OUTLINE

uRAM Pins		
No.	Function	Label
1	+In	+
2	Control	SC
3	C ext.	CTRAN
4	-In	-
5	-Out	-
6	Reference	Vref
7	+Out	+

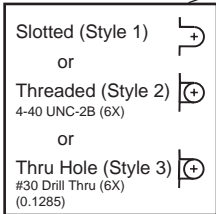
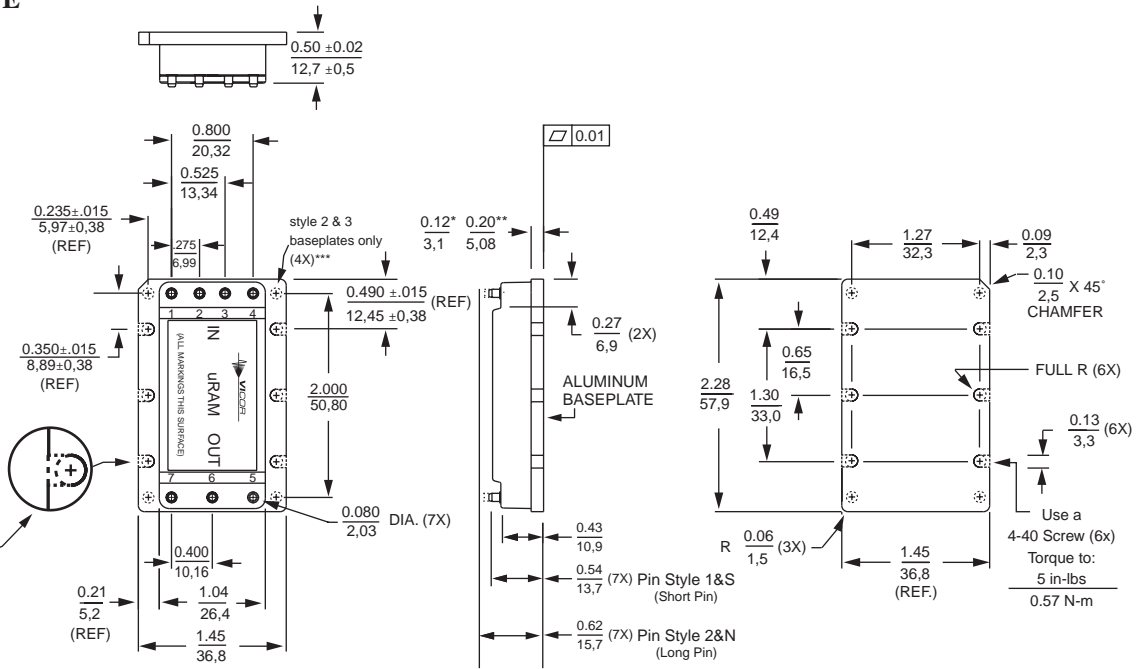

* Style 1 baseplate only
** Style 2 & 3 baseplates
*** Reserved for Vicor accessories
Not for mounting

PCB MOUNTING SPECIFICATIONS

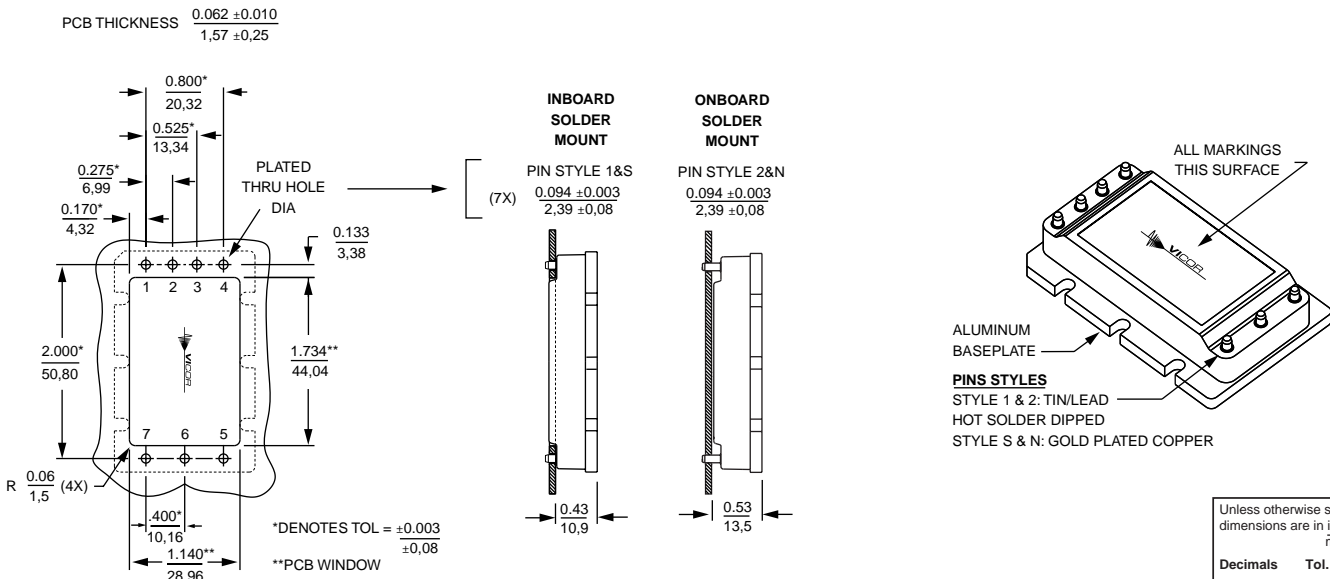

Unless otherwise specified, dimensions are in inches mm

Decimals	Tol.	Angles
0.XX	±0.01 ±0.25	±1°
0.XXX	±0.005 ±0.127	