

SIEMENS

IL55B PHOTODARLINGTON OPTOCOUPLER

FEATURES

- **High Collector-Emitter Breakdown Voltage—80 V minimum**
- **High Isolation Resistance, 10¹¹ W Typical**
- **Standard Plastic DIP Package**
- **Underwriters Lab File #E52744**
-  **VDE 0884 Available with Option 1**

DESCRIPTION

The IL55B is an optically coupled isolator with a Gallium Arsenide infrared LED and a silicon photodarlington sensor. Switching can be achieved while maintaining a high degree of isolation between driving and load circuits. These optocouplers can be used to replace reed and mercury relays with advantages of long life, high speed switching and elimination of magnetic fields.

Maximum Ratings

Emitter

Peak Reverse Voltage 3 V
 Continuous Forward Current 60 mA
 Power Dissipation at 25°C 100 mW
 Derate Linearly from 55°C 1.33 mW/°C

Detector

Collector-Emitter Breakdown Voltage, BV_{CEO} 80 V
 Emitter-Collector Breakdown Voltage BV_{ECO} 5 V
 Collector (load) Current 125 mA
 Power Dissipation at 25°C Ambient 150 mW
 Derate Linearly from 25°C 2.0 mW/°C

Package

Total Dissipation at 25°C Ambient 250 mW
 Derate Linearly from 25°C 3.3 mW/°C
 Isolation Test Voltage (between emitter and detector referred to standard climate 23°C/50%RH, DIN 50014) 5300 VAC_{RMS}
 Creepage 7 mm min.
 Clearance 7 mm min.
 Tracking Resistance, Group III (KC>600 per VDE 110 § 6, Table 3 and DIN 53480/VDE 0330, Part 1)
 Isolation Resistance
 $V_{IO}=500$ V, $T_A=25^\circ\text{C}$ 10¹² Ω
 $V_{IO}=500$ V, $T_A=100^\circ\text{C}$ 10¹¹ Ω
 Storage Temperature -55°C to +150°C
 Operating Temperature -55°C to +100°C
 Lead Soldering Time at 260°C 10 sec.

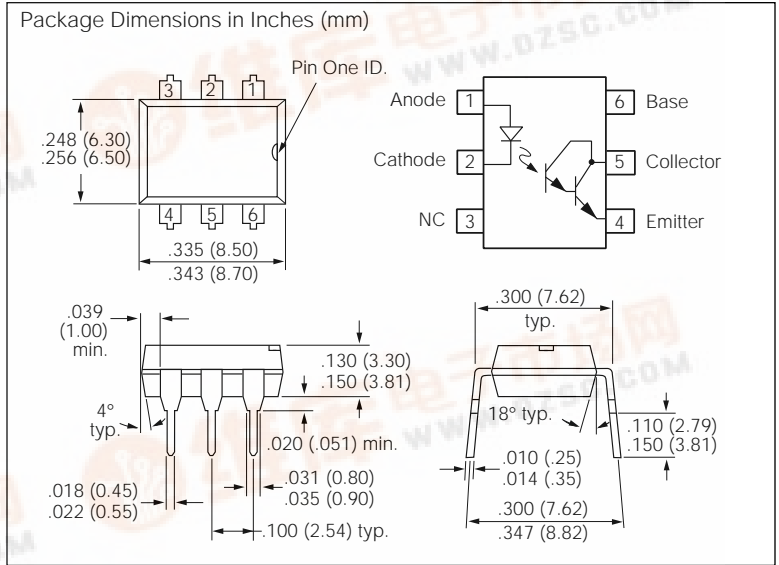

Electrical Characteristics ($T_A=25^\circ\text{C}$)

Parameter	Min.	Typ.	Max.	Unit	Condition
Emitter					
Forward Voltage*		1.25	1.5	V	$I_F=50$ mA
Reverse Current*		0.1	10	μA	$V_R=3.0$ V
Capacitance		25		pF	$V_R=0$ V
Detector					
BV_{CEO}	80			V	$I_C=1$ mA, $I_F=0$
BV_{ECO}	5	10		V	$I_E=100$ μA, $I_F=0$
I_{CEO}			1	μA	$V_{CE}=60$ V, $I_F=0$
Package					
Current Transfer Ratio	500			%	$I_F=10$ mA, $V_{CE}=1.5$ V
Coupling Capacitance		1.5		pF	
Turn-On Time		5		μs	$V_{CC}=10$ V
Turn -Off Time		100		μs	$I_F=5$ mA, $R_L=100$ Ω

Figure 1. Forward voltage versus forward current

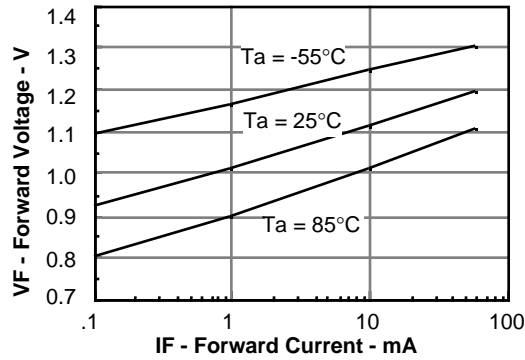

Figure 2. Normalized non-saturated and saturated CTR_{ce} at $T_A=25^\circ\text{C}$ versus LED current

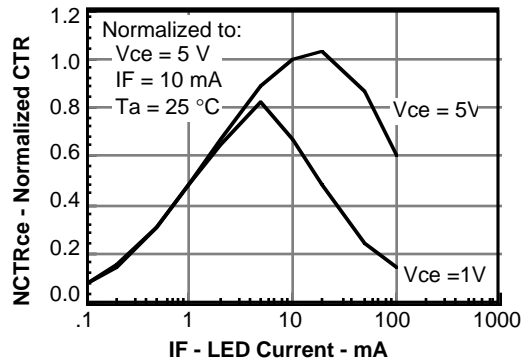

Figure 3. Normalized non-saturated and saturated collector-emitter current versus LED current

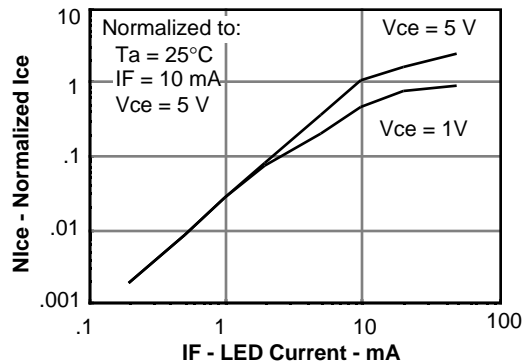

Figure 4. Low to high propagation delay versus collector load resistance and LED current

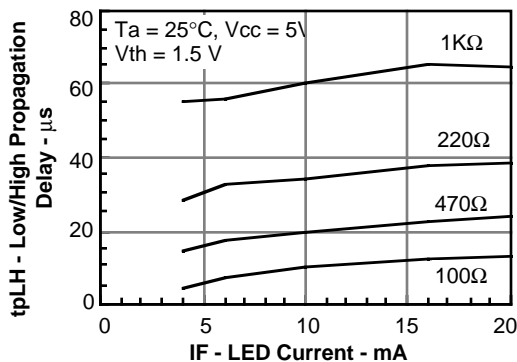

Figure 5. High to low propagation delay versus collector load resistance and LED current

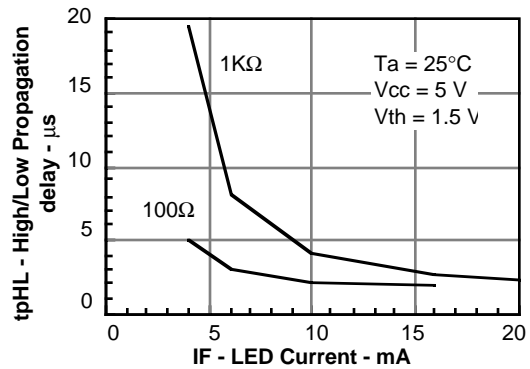

Figure 6. Switching waveforms

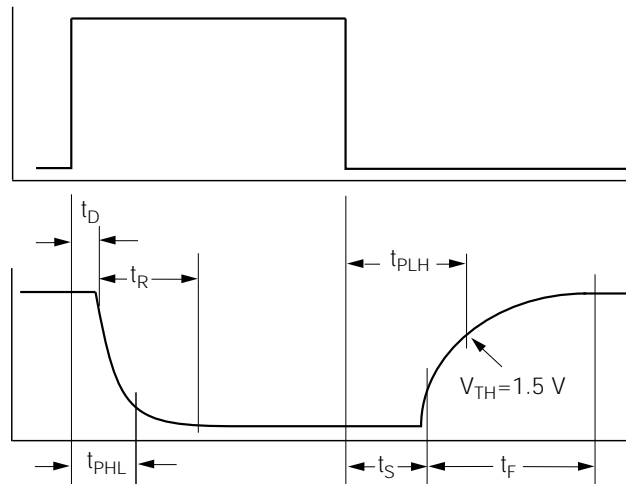

Figure 7. Switching schematic

