



December 1996

## LMC6572 Dual/LMC6574 Quad Low Voltage (2.7V and 3V) Operational Amplifier

### General Description

Low voltage operation and low power dissipation make the LMC6574/2 ideal for battery-powered systems.

3V amplifier performance is backed by 2.7V guarantees to ensure operation throughout battery lifetime. These guarantees also enable analog circuits to operate from the same 3.3V supply used for digital logic.

Battery life is maximized because each amplifier dissipates only micro-watts of power.

The LMC6574/2 does not sacrifice functionality for low voltage operation. The LMC6574/2 generates 120 dB of open-loop gain just like a conventional amplifier, but the LMC6574/2 can do this from a 2.7V supply.

These amplifiers are designed with features that optimize low voltage operation. The output voltage swings rail-to-rail to maximize signal-to-noise ratio and dynamic signal range. The common-mode input voltage range extends from 800 mV below the positive supply to 100 mV below ground.

This device is built with National's advanced Double-Poly Silicon-Gate CMOS process.

LMC6572 is also available in MSOP package which is almost half the size of a SO-8 device.

### Features

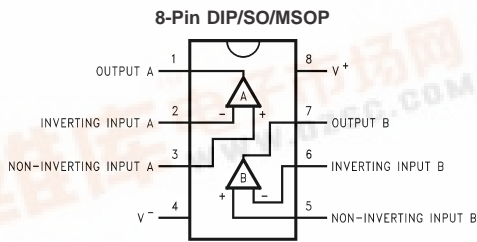
(Typical unless otherwise noted)

- Guaranteed 2.7V and 3V Performance
- Rail-to-Rail Output Swing (within 5 mV of supply rail, 100 k $\Omega$  load)
- Ultra-Low Supply Current: 40  $\mu$ A/Amplifier
- Low Cost
- Ultra-Low Input Current: 20 fA
- High Voltage Gain @  $V_S=2.7V$ ,  $R_L=100$  k $\Omega$ : 120 dB
- Specified for 100 k $\Omega$  and 5 k $\Omega$  loads
- Available in MSOP Package

### Applications

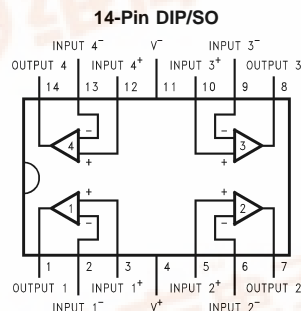
- Transducer Amplifier
- Portable or Remote Equipment
- Battery-Operated Instruments
- Data Acquisition Systems
- Medical Instrumentation
- Improved Replacement for TLV2322 and TLV2324

### Connection Diagrams



DS011934-1

Order Number LMC6572AIN, LMC6572BIN,  
LMC6572AIM, LMC6572BIM or LMC6572BIMM  
See NS Package Number N08E, M08A or MUA08A



DS011934-2

Order Number LMC6574AIN, LMC6574BIN,  
LMC6574AIM or LMC6574BIM  
See NS Package Number N14A or M14A

LMC6572 Dual/LMC6574 Quad Low Voltage (2.7V and 3V) Operational Amplifier



## Ordering Information

Package	Temperature Range Industrial, -40°C to +85°C	NSC Drawing	Transport Media
8-Pin Molded DIP	LMC6572AIN, LMC6572BIN	N08E	Rail
8-Pin Small Outline	LMC6572AIM, LMC6572BIM	M08A	Rail
	LMC6572AIMX, LMC6572BIMX		Tape and Reel
8-Pin Mini SO	LMC6572BIMM	MUA08A	Rail
	LMC6572BIMMX		Tape and Reel
14-Pin Molded DIP	LMC6574AIN, LMC6574BIN	N14A	Rail
14-Pin Small Outline	LMC6574AIM, LMC6574BIM	M14A	Rail
	LMC6574AIMX, LMC6574BIMX		Tape and Reel

## Absolute Maximum Ratings (Note 1)

If Military/Aerospace specified devices are required, please contact the National Semiconductor Sales Office/Distributors for availability and specifications.

ESD Tolerance (Note 2)	2000V
Differential Input Voltage	±Supply Voltage
Voltage at Input/Output Pin	(V <sup>+</sup> ) +0.3V, (V <sup>-</sup> ) -0.3V
Supply Voltage (V <sup>+</sup> - V <sup>-</sup> )	12V
Current at Input Pin	±5 mA
Current at Output Pin (Note 3)	±10 mA
Current at Power Supply Pin	35 mA
Lead Temperature (Soldering, 10 Seconds)	260°C
Storage Temperature Range	-65°C to +150°C

Junction Temperature (Note 4)

150°C

## Operating Ratings (Note 1)

Supply Voltage	2.7V ≤ V <sup>+</sup> ≤ 11V
Junction Temperature Range	LMC6572AI, LMC6572BI LMC6574AI, LMC6574BI -40°C ≤ T <sub>J</sub> ≤ +85°C
Thermal Resistance (θ <sub>JA</sub> )	N Package, 8-Pin Molded DIP M Package, 8-Pin Surface Mount MSOP Package, 8-Pin Mini SO N Package, 14-Pin Molded DIP M Package, 14-Pin Surface Mount
	115°C/W 193°C/W 217°C/W 81°C/W 126°C/W

## 2.7V DC Electrical Characteristics

Unless otherwise specified, all limits guaranteed for T<sub>J</sub> = 25°C. V<sup>+</sup> = 2.7V, V<sup>-</sup> = 0V, V<sub>CM</sub> = V<sub>O</sub> = V<sup>+</sup>/2 and R<sub>L</sub> > 1MΩ. **Bold-face** limits apply at the temperature extremes.

Symbol	Parameter	Conditions	Typ (Note 5)	LMC6574AI LMC6572AI Limit (Note 6)	LMC6574BI LMC6572BI Limit (Note 6)	Units
V <sub>OS</sub>	Input Offset Voltage	V <sup>+</sup> = 2.7V and 3V	0.5	3 <b>3.5</b>	7 <b>7.5</b>	mV Max
TCV <sub>OS</sub>	Input Offset Voltage Average Drift		1.5			µV/°C
I <sub>B</sub>	Input Current		0.02	<b>10</b>	<b>10</b>	pA Max
I <sub>OS</sub>	Input Offset Current		0.01	<b>6</b>	<b>6</b>	pA Max
R <sub>IN</sub>	Input Resistance		>1			Tera Ω
C <sub>IN</sub>	Common-Mode Input Capacitance		3			pF
CMRR	Common Mode Rejection Ratio	0V ≤ V <sub>CM</sub> ≤ 3.5V V <sup>+</sup> = 5V	75	63 <b>60</b>	60 <b>57</b>	dB Min
+PSRR	Positive Power Supply Rejection Ratio	2.7V ≤ V <sup>+</sup> ≤ 5V, V <sup>-</sup> = 0V	75	67 <b>65</b>	60 <b>58</b>	dB Min
-PSRR	Negative Power Supply Rejection Ratio	-2.7V ≤ V <sup>-</sup> ≤ -5V, V <sup>+</sup> = 0V	83	75 <b>73</b>	67 <b>65</b>	dB Min
V <sub>CM</sub>	Input Common-Mode Voltage Range	V <sup>+</sup> = 2.7V and 3V for CMRR ≥ 50 dB	-0.1	-0.05 <b>0</b>	-0.05 <b>0</b>	V Max
			V <sup>+</sup> - 0.8	V <sup>+</sup> - 1.0 <b>V<sup>+</sup> - 1.3</b>	V <sup>+</sup> - 1.0 <b>V<sup>+</sup> - 1.3</b>	V Min
A <sub>V</sub>	Large Signal Voltage Gain	R <sub>L</sub> = 100 kΩ (Note 7)				
		Sourcing	1000			V/mV
		Sinking	500			V/mV

## 2.7V DC Electrical Characteristics (Continued)

Unless otherwise specified, all limits guaranteed for  $T_J = 25^\circ\text{C}$ ,  $V^+ = 2.7\text{V}$ ,  $V^- = 0\text{V}$ ,  $V_{\text{CM}} = V_O = V^+/2$  and  $R_L > 1\text{M}\Omega$ . **Bold-face** limits apply at the temperature extremes.

Symbol	Parameter	Conditions	Typ (Note 5)	LMC6574AI	LMC6574BI	Units	
				LMC6572AI Limit (Note 6)	LMC6572BI Limit (Note 6)		
$V_O$	Output Swing	$V^+ = 2.7\text{V}$ $R_L = 100\text{ k}\Omega$ to $V^+/2$	2.695	2.68 <b>2.66</b>	2.65 <b>2.62</b>	V Min	
			0.005	0.03 <b>0.05</b>	0.06 <b>0.09</b>	V Max	
		$V^+ = 2.7\text{V}$ $R_L = 5\text{ k}\Omega$ to $V^+/2$	2.66	2.55 <b>2.45</b>	2.45 <b>2.35</b>	V Min	
			0.04	0.15 <b>0.25</b>	0.25 <b>0.35</b>	V Max	
		$V^+ = 3\text{V}$ $R_L = 100\text{ k}\Omega$ to $V^+/2$	2.995	2.98 <b>2.96</b>	2.95 <b>2.93</b>	V Min	
			0.005	0.03 <b>0.05</b>	0.06 <b>0.09</b>	V Max	
	$V^+ = 3\text{V}$ $R_L = 5\text{ k}\Omega$ to $V^+/2$	2.96	2.85 <b>2.75</b>	2.75 <b>2.65</b>	V Min		
		0.04	0.15 <b>0.25</b>	0.25 <b>0.35</b>	V Max		
	$I_{\text{SC}}$	Output Short Circuit Current	Sourcing, $V_O = 0\text{V}$	6.0	4.0 <b>3.0</b>	3.0 <b>2.0</b>	mA Min
			Sinking, $V_O = 2.7\text{V}$	4.0	3.0 <b>2.0</b>	2.5 <b>1.5</b>	mA Min
		Supply Current	Quad Package $V^+ = +2.7\text{V}$ , $V_O = V^+/2$	160	240 <b>280</b>	240 <b>280</b>	$\mu\text{A}$ Max
			Quad Package $V^+ = +3\text{V}$ , $V_O = V^+/2$	160	240 <b>280</b>	240 <b>280</b>	$\mu\text{A}$ Max
Dual Package $V^+ = +2.7\text{V}$ , $V_O = V^+/2$	80	120 <b>140</b>	120 <b>140</b>	$\mu\text{A}$ Max			
	Dual Package $V^+ = +3\text{V}$ , $V_O = V^+/2$	80	120 <b>140</b>	120 <b>140</b>	$\mu\text{A}$ Max		

## 2.7V AC Electrical Characteristics

Unless otherwise specified, all limits guaranteed for  $T_J = 25^\circ\text{C}$ ,  $V^+ = 2.7\text{V}$ ,  $V^- = 0\text{V}$ ,  $V_{\text{CM}} = V_O = V^+/2$  and  $R_L > 1\text{M}\Omega$ . **Bold-face** limits apply at the temperature extremes.

Symbol	Parameter	Conditions	Typ (Note 5)	LMC6574AI	LMC6574BI	Units
				LMC6572AI Limit (Note 6)	LMC6572BI Limit (Note 6)	
SR	Slew Rate	$V^+ = 2.7\text{V}$ and $3\text{V}$ (Note 8)	90	30 <b>10</b>	30 <b>10</b>	V/ms Min
GBW	Gain-Bandwidth Product	$V^+ = 3\text{V}$	0.22			MHz
$\phi_m$	Phase Margin		60			Deg
$G_m$	Gain Margin		12			dB
	Amp-to-Amp Isolation	(Note 9)	120			dB
$e_n$	Input-Referred Voltage Noise	$F = 1\text{ kHz}$ $V_{\text{CM}} = 1\text{V}$	45			$\text{nV}/\sqrt{\text{Hz}}$
	Input-Referred	$F = 1\text{ kHz}$	0.002			$\text{pA}/\sqrt{\text{Hz}}$

## 2.7V AC Electrical Characteristics (Continued)

Unless otherwise specified, all limits guaranteed for  $T_J = 25^\circ\text{C}$ ,  $V^+ = 2.7\text{V}$ ,  $V^- = 0\text{V}$ ,  $V_{\text{CM}} = V_O = V^+/2$  and  $R_L > 1\text{M}\Omega$ . **Bold-face** limits apply at the temperature extremes.

Symbol	Parameter	Conditions	Typ (Note 5)	LMC6574AI LMC6572AI Limit (Note 6)	LMC6574BI LMC6572BI Limit (Note 6)	Units
	Current Noise					
T.H.D.	Total Harmonic Distortion	$F = 10\text{ kHz}$ , $A_V = -2$ $R_L = 10\text{ k}\Omega$ , $V_O = 1.0\text{ V}_{\text{PP}}$	0.05			%

**Note 1:** Absolute Maximum Ratings indicate limits beyond which damage to the device may occur. Operating Ratings indicate conditions for which the device is intended to be functional, but specific performance is not guaranteed. For guaranteed specifications and test conditions, see the Electrical Characteristics.

**Note 2:** Human body model, 1.5 k $\Omega$  in series with 100 pF.

**Note 3:** Applies to both single-supply and split-supply operation. Continuous short circuit operation at elevated ambient temperature can result in exceeding the maximum allowed junction temperature of 150°C.

**Note 4:** The maximum power dissipation is a function of  $T_{\text{J(Max)}}$ ,  $\theta_{\text{JA}}$ , and  $T_{\text{A}}$ . The maximum allowable power dissipation at any ambient temperature is  $P_D = (T_{\text{J(Max)}} - T_{\text{A}})/\theta_{\text{JA}}$ . All numbers apply for packages soldered directly into a PC board.

**Note 5:** Typical values represent the most likely parametric norm.

**Note 6:** All limits are guaranteed by testing or statistical analysis.

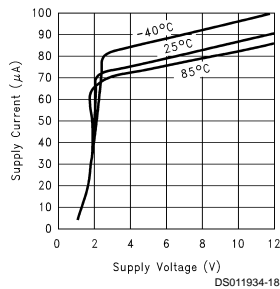
**Note 7:**  $V^+ = 3\text{V}$ ,  $V_{\text{CM}} = 1.5\text{V}$  and  $R_L$  connected to 1.5V. For Sourcing tests,  $1.5\text{V} \leq V_O \leq 2.5\text{V}$ . For Sinking tests,  $0.5\text{V} \leq V_O \leq 1.5\text{V}$ .

**Note 8:** Connected as Voltage Follower with 1.0V step input. Number specified is the slower of the positive and negative slew rates.

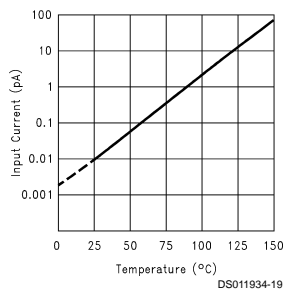
**Note 9:** Input referred,  $V^+ = 3\text{V}$  and  $R_L = 100\text{ k}\Omega$  connected to 1.5V. Each amp excited in turn with 1 KHz to produce  $V_O = 2\text{ V}_{\text{PP}}$ .

## Typical Performance Characteristics $V_S = +3\text{V}$ , $T_A = 25^\circ\text{C}$ , Unless otherwise specified

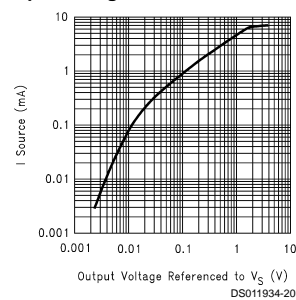
**Supply Current vs Supply Voltage (Dual Package)**



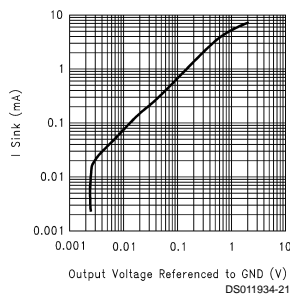
**Input Current vs Temperature**



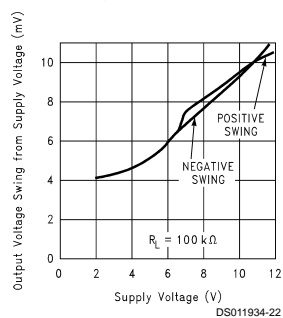
**Sourcing Current vs Output Voltage**



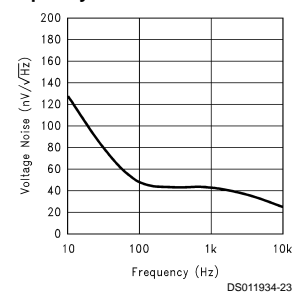
**Sinking Current vs Output Voltage**



**Output Voltage Swing vs Supply Voltage**

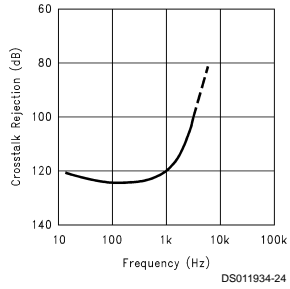


**Input Voltage Noise vs Frequency**

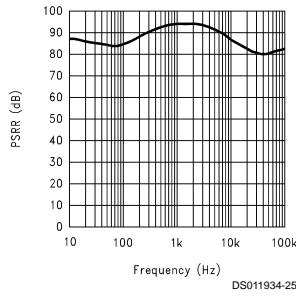


**Typical Performance Characteristics**  $V_S = +3V$ ,  $T_A = 25^\circ C$ , Unless otherwise specified (Continued)

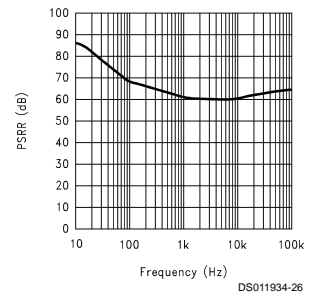
**Crosstalk Rejection vs Frequency**



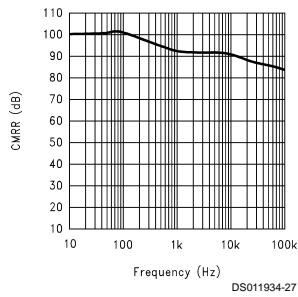
**Positive PSRR vs Frequency**



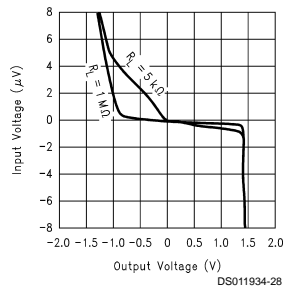
**Negative PSRR vs Frequency**



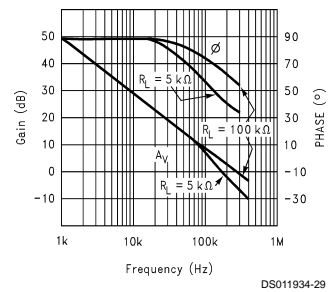
**CMRR vs Frequency**



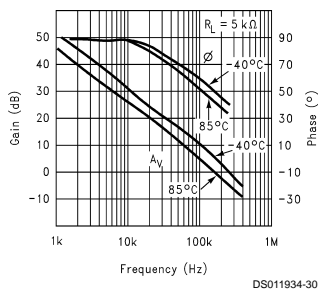
**Input Voltage vs Output Voltage ( $V_S = \pm 1.5$ )**



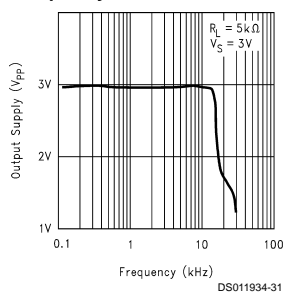
**Open Loop Frequency Response**



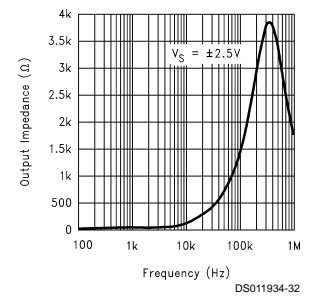
**Open Loop Frequency Response vs Temperature**



**Maximum Output Swing vs Frequency**

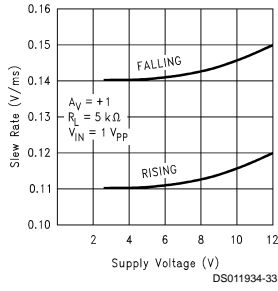


**$Z_{OUT}$  vs Frequency**

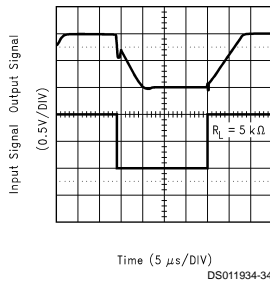


**Typical Performance Characteristics**  $V_S = +3V$ ,  $T_A = 25^\circ C$ , Unless otherwise specified (Continued)

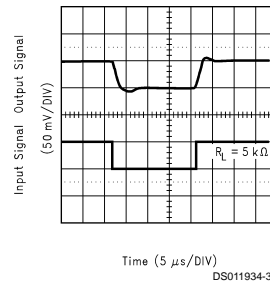
**Slew Rate vs Supply Voltage**



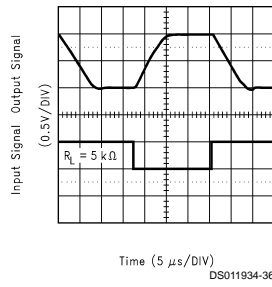
**Non-Inverting Large Signal Pulse Response**



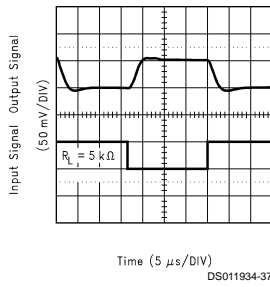
**Non-Inverting Small Signal Pulse Response**



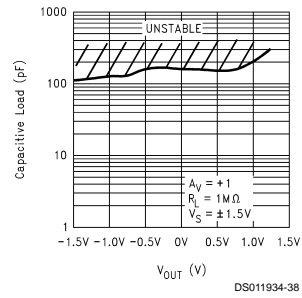
**Inverting Large Signal Pulse Response**



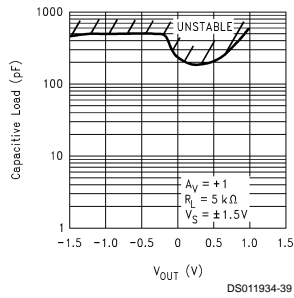
**Inverting Small Signal Pulse Response**



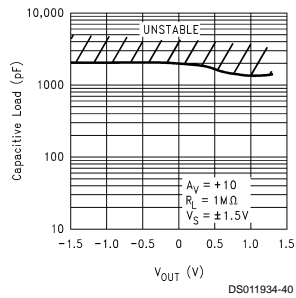
**Stability vs Capacitive Load**



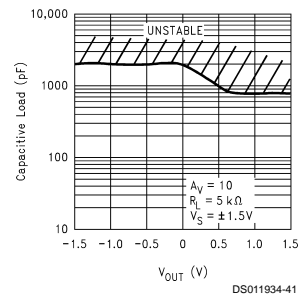
**Stability vs Capacitive Load**



**Stability vs Capacitive Load**

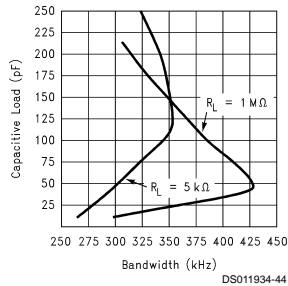


**Stability vs Capacitive Load**

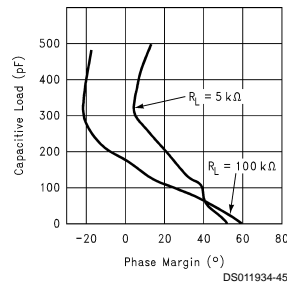


## Typical Performance Characteristics $V_S = +3V$ , $T_A = 25^\circ C$ , Unless otherwise specified (Continued)

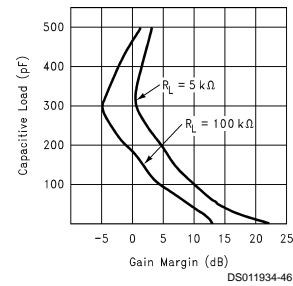
### Bandwidth vs Capacitive Load



### Capacitive Load vs Phase Margin



### Capacitive Load vs Gain Margin



## Applications Hints

### 1.0 LOW VOLTAGE AMPLIFIER TOPOLOGY

The LMC6574/2 incorporates a novel op-amp design topology that enables it to maintain rail-to-rail output swing even when driving a large load. Instead of relying on a push-pull unity gain output buffer stage, the output stage is taken directly from the internal integrator, which provides both low output impedance and large gain. Special feed-forward compensation design techniques are incorporated to maintain stability over a wider range of operating conditions than traditional micropower op-amps. These features make the LMC6574/2 both easier to design with, and provide higher speed than products typically found in this ultra-low power class.

### 2.0 COMPENSATING FOR INPUT CAPACITANCE

It is quite common to use large values of feedback resistance for amplifiers with ultra-low input current, like the LMC6574/2.

Although the LMC6574/2 is highly stable over a wide range of operating conditions, a large feedback resistor will react even with small values of capacitance at the input of the op-amp to reduce phase margin. The capacitance at the input of the op-amp comes from transducers, photodiodes and circuit board parasitics.

The effect of input capacitance can be compensated for by adding a capacitor,  $C_f$ , around the feedback resistors (as in Figure 1) such that:

$$\frac{1}{2\pi R_1 C_{IN}} \geq \frac{1}{2\pi R_2 C_f}$$

or

$$R_1 C_{IN} \leq R_2 C_f$$

Since it is often difficult to know the exact value of  $C_{IN}$ ,  $C_f$  can be experimentally adjusted so that the desired pulse response is achieved. Refer to the LMC660 and LMC662 for a more detailed discussion on compensating for input capacitance.

When high input impedances are demanded, guarding of the LMC6574/2 is suggested. Guarding input lines will not only reduce leakage, but lowers stray input capacitance as well. (See *Printed-Circuit-Board Layout for High Impedance Work*).

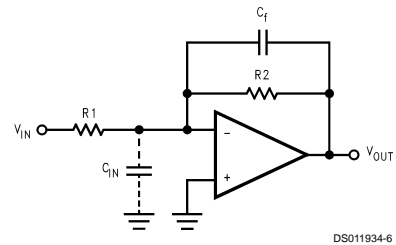


FIGURE 1. Cancelling the Effect of Input Capacitance

### 3.0 CAPACITIVE LOAD TOLERANCE

Direct capacitive loading will reduce the phase margin of many op-amps. A pole in the feedback loop is created by the combination of the op-amp's output impedance and the capacitive load. This pole induces phase lag at the unity-gain crossover frequency of the amplifier resulting in either an oscillatory or underdamped pulse response. With a few external components, op amps can easily indirectly drive capacitive loads, as shown in Figure 2.

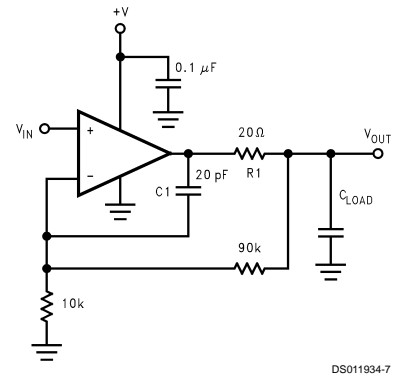


FIGURE 2. LMC6574/2 Noninverting Gain of 10 Amplifier, Compensated to Handle Capacitive Loads

In the circuit of Figure 2, R1 and C1 serve to counteract the loss of phase margin by feeding the high frequency compo-



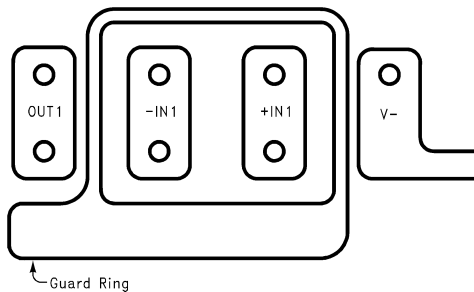
## Applications Hints (Continued)

ment of the output signal back to the amplifier's inverting input, thereby preserving phase margin in the overall feedback loop.

### 4.0 PRINTED-CIRCUIT-BOARD LAYOUT FOR HIGH-IMPEDANCE WORK

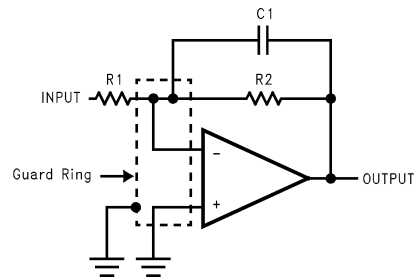
It is generally recognized that any circuit which must operate with less than 1000 pA of leakage current requires special layout of the PC board. When one wishes to take advantage of the ultra-low bias current of the LMC6574/2, typically less than 20 fA, it is essential to have an excellent layout. Fortunately, the techniques of obtaining low leakages are quite simple. First, the user must not ignore the surface leakage of the PC board, even though it may sometimes appear acceptably low, because under conditions of high humidity or dust or contamination, the surface leakage will be appreciable.

To minimize the effect of any surface leakage, lay out a ring of foil completely surrounding the LMC6574/2's inputs and the terminals of capacitors, diodes, conductors, resistors, relay terminals, etc. connected to the op-amp's inputs, as in Figure 3. To have a significant effect, guard rings should be placed on both the top and bottom of the PC board. This PC foil must then be connected to a voltage which is at the same voltage as the amplifier inputs, since no leakage current can flow between two points at the same potential. For example, a PC board trace-to-pad resistance of  $10^{12}\Omega$ , which is normally considered a very large resistance, could leak 5 pA if the trace were a 5V bus adjacent to the pad of the input. This would cause a 250 times degradation from the LMC6574/2's actual performance. However, if a guard ring is held within 5 mV of the inputs, then even a resistance of  $10^{11}\Omega$  would cause only 0.05 pA of leakage current. See Figure 4 for typical connections of guard rings for standard op-amp configurations.



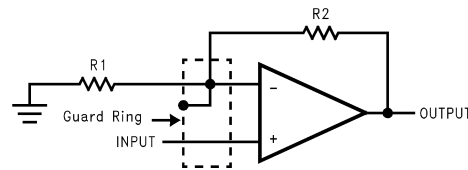
DS011934-8

FIGURE 3. Example of Guard Ring in P.C. Board Layout



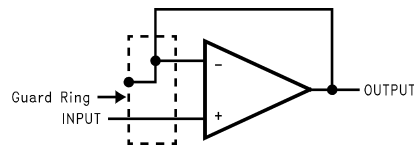
DS011934-9

Inverting Amplifier



DS011934-10

Non-Inverting Amplifier

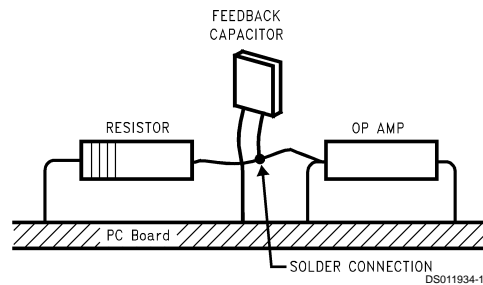


DS011934-11

Follower

FIGURE 4. Typical Connections of Guard Rings

The designer should be aware that when it is inappropriate to lay out a PC board for the sake of just a few circuits, there is another technique which is even better than a guard ring on a PC board: Don't insert the amplifier's input pin into the board at all, but bend it up in the air and use only air as an insulator. Air is an excellent insulator. In this case you may have to forego some of the advantages of PC board construction, but the advantages are sometimes well worth the effort of using point-to-point up-in-the-air wiring. See Figure 5.



DS011934-12

(Input pins are lifted out of PC board and soldered directly to components. All other pins connected to PC board).

FIGURE 5. Air Wiring

## Applications Hints (Continued)

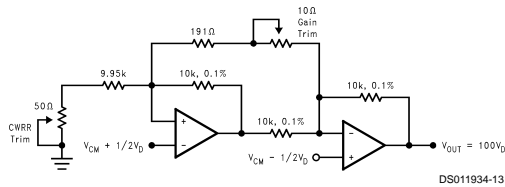
### 5.0 SPICE MACROMODEL

A spice macromodel is available for the LMC6574/2. This model includes accurate simulation of:

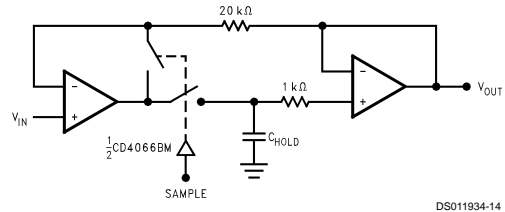
- input common-mode voltage range
  - frequency and transient response
  - GBW dependence on loading conditions
  - quiescent and dynamic supply current
  - output swing dependence on loading conditions
- and many more characteristics as listed on the macromodel disk.

Contact your local National Semiconductor sales office to obtain an operational amplifier spice model library disk.

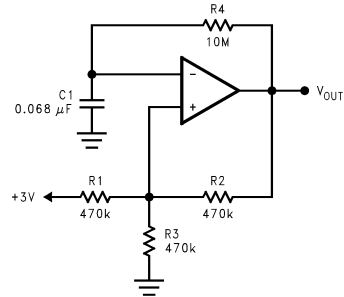
### Typical Single-Supply Applications



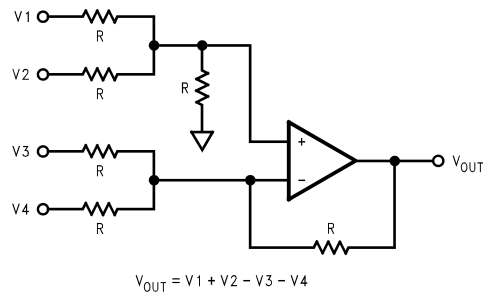
**FIGURE 6. Low-Power Two-Op-Amp Instrumentation Amplifier**



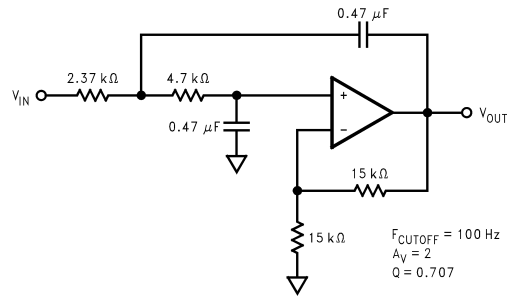
**FIGURE 7. Sample and Hold**



**FIGURE 8. 1 Hz Square Wave Oscillator**

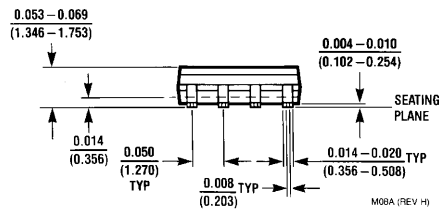
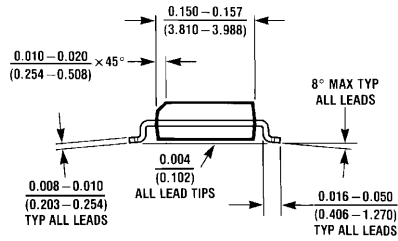
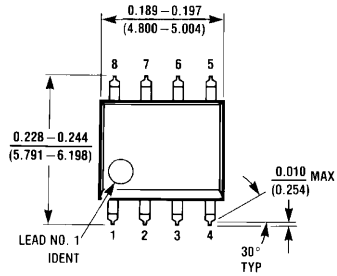


**FIGURE 9. Adder/Subtractor Circuit**

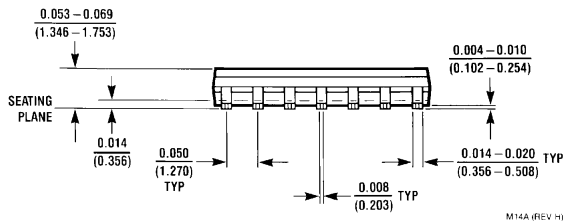
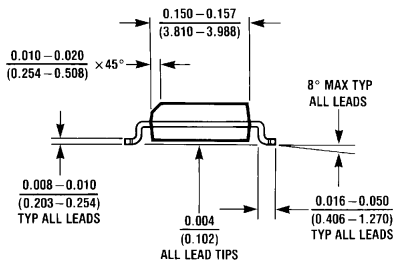
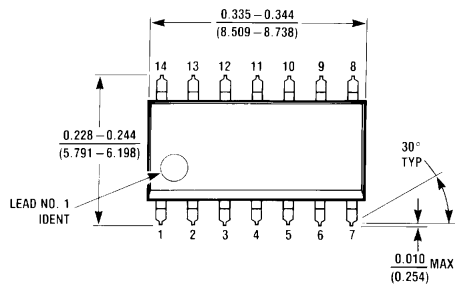


**FIGURE 10. Low Pass Filter**

**Physical Dimensions** inches (millimeters) unless otherwise noted

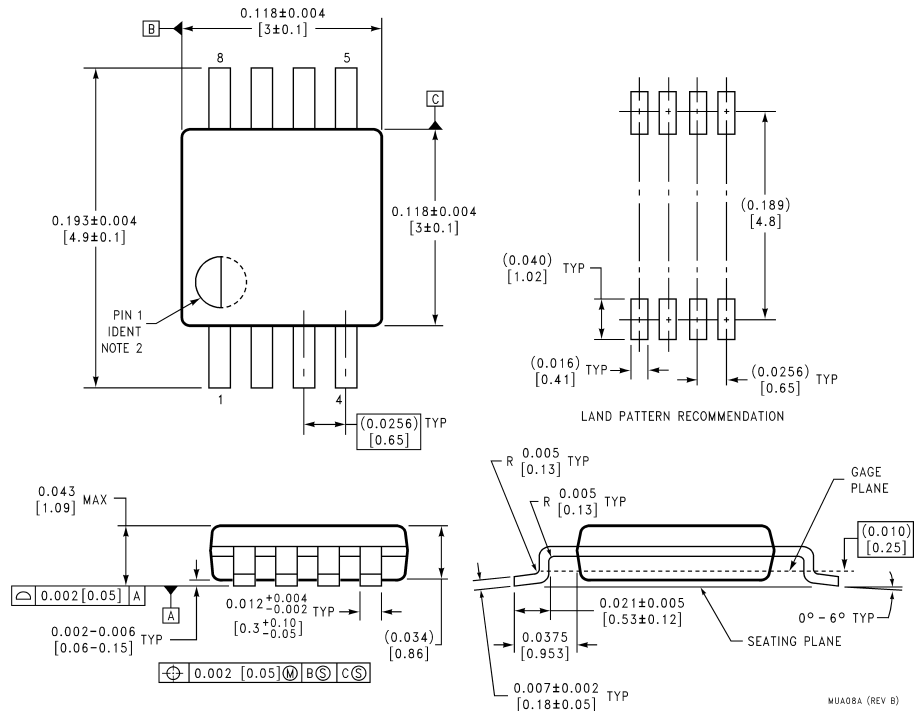


**8-Pin Small Outline Package**  
**Order Package Number LMC6572AIM or LMC6572BIM**  
**NS Package Number M08A**

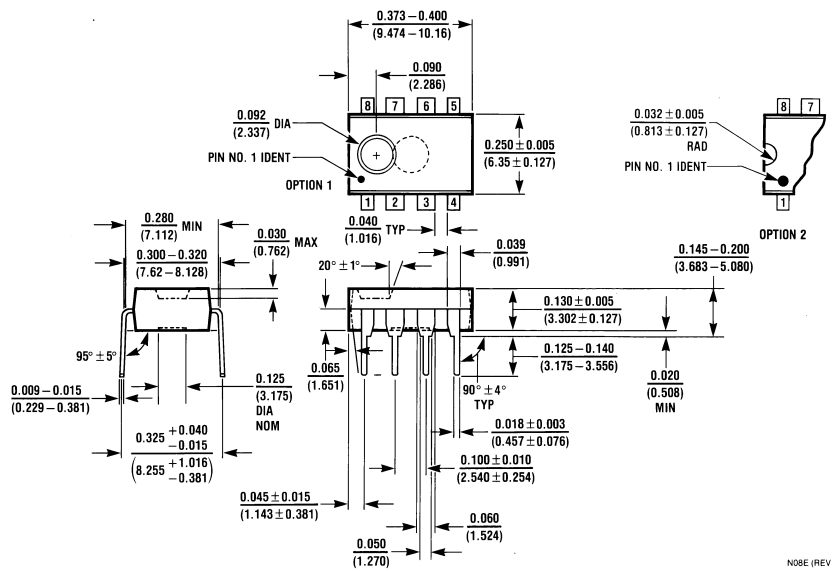


**14-Pin Small Outline Package**  
**Order Package Number LMC6574AIM or LMC6574BIM**  
**NS Package Number M14A**

**Physical Dimensions** inches (millimeters) unless otherwise noted (Continued)

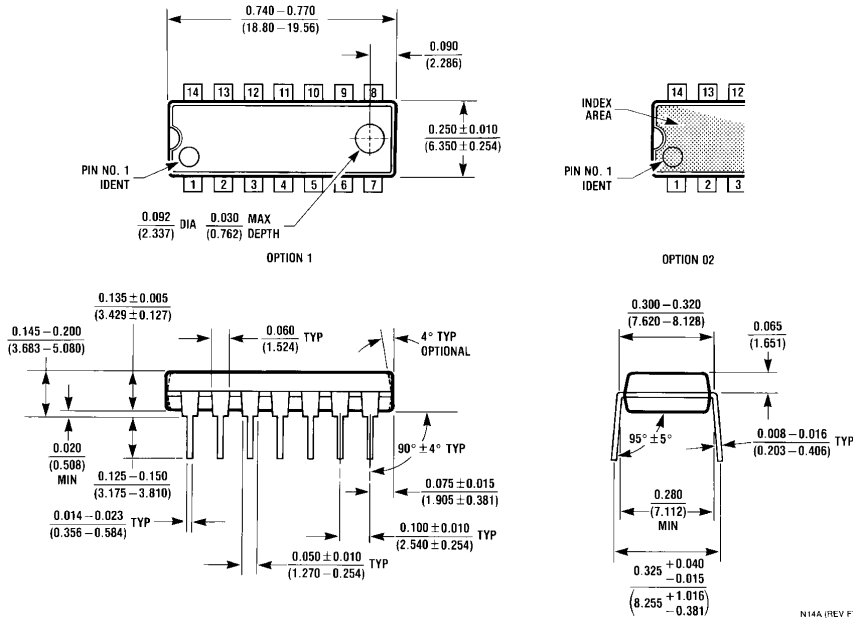


**8-Lead Mini-Small Outline Molded Package, JEDEC**  
**Order Number LMC6572BIMM or LMC6572BIMMX**  
**NS Package Number MUA08A**



**8-Pin Molded Dual-In-Line Package**  
**Order Number LMC6572AIN or LMC6572BIN**  
**NS Package Number N08E**

**Physical Dimensions** inches (millimeters) unless otherwise noted (Continued)



**14-Pin Molded Dual-In-Line Package**  
**Order Number LMC6574AIN or LMC6574BIN**  
**NS Package Number N14A**

**LIFE SUPPORT POLICY**

NATIONAL'S PRODUCTS ARE NOT AUTHORIZED FOR USE AS CRITICAL COMPONENTS IN LIFE SUPPORT DEVICES OR SYSTEMS WITHOUT THE EXPRESS WRITTEN APPROVAL OF THE PRESIDENT AND GENERAL COUNSEL OF NATIONAL SEMICONDUCTOR CORPORATION. As used herein:

1. Life support devices or systems are devices or systems which, (a) are intended for surgical implant into the body, or (b) support or sustain life, and whose failure to perform when properly used in accordance with instructions for use provided in the labeling, can be reasonably expected to result in a significant injury to the user.
2. A critical component is any component of a life support device or system whose failure to perform can be reasonably expected to cause the failure of the life support device or system, or to affect its safety or effectiveness.

**National Semiconductor Corporation**  
 Americas  
 Tel: 1-800-272-9959  
 Fax: 1-800-737-7018  
 Email: support@nsc.com

**National Semiconductor Europe**  
 Fax: +49 (0) 1 80-530 85 86  
 Email: europe.support@nsc.com  
 Deutsch Tel: +49 (0) 1 80-530 85 85  
 English Tel: +49 (0) 1 80-532 78 32  
 Français Tel: +49 (0) 1 80-532 93 58  
 Italiano Tel: +49 (0) 1 80-534 16 80

**National Semiconductor Asia Pacific Customer Response Group**  
 Tel: 65-2544466  
 Fax: 65-2504466  
 Email: sea.support@nsc.com

**National Semiconductor Japan Ltd.**  
 Tel: 81-3-5639-7560  
 Fax: 81-3-5639-7507

www.national.com