



# 2.4 GHz Low Noise Silicon MMIC Amplifier

## Technical Data

### Features

- Ultra-Miniature Package
- Internally Biased, Single 5 V Supply (12 mA)
- 20.5 dB Gain
- 3 dB NF
- Unconditionally Stable

### Applications

- Amplifier for Cellular, Cordless, Special Mobile Radio, PCS, ISM, Wireless LAN, DBS, TVRO, and TV Tuner Applications

### Surface Mount SOT-363 (SC-70) Package

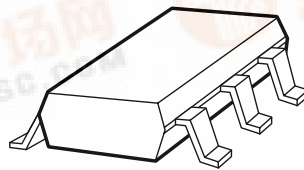

### Pin Connections and Package Marking

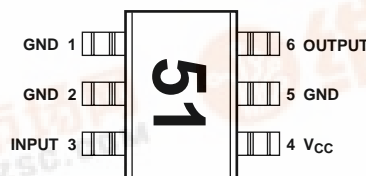

Note: Package marking provides orientation and identification.

### Equivalent Circuit (Simplified)

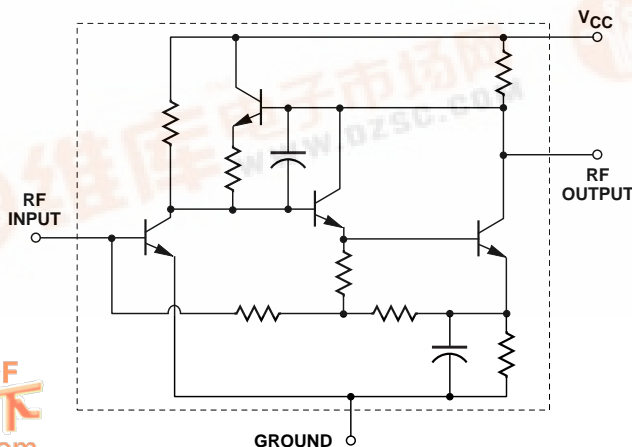

## INA-51063

### Description

Hewlett-Packard's INA-51063 is a Silicon monolithic amplifier that offers excellent gain and noise figure for applications to 2.4 GHz. Packaged in an ultra-miniature SOT-363 package, it requires half the board space of a SOT-143 package.

The INA-51063 uses a topology which is internally biased, eliminating the need for external components and providing decreased sensitivity to ground inductance.

The INA-51063 is fabricated using HP's 30 GHz  $f_{MAX}$  ISOSAT™ Silicon bipolar process which uses nitride self-alignment sub-micrometer lithography, trench isolation, ion implantation, gold metallization, and polyimide intermetal dielectric and scratch protection to achieve superior performance, uniformity, and reliability.



## Absolute Maximum Ratings

Symbol	Parameter	Units	Absolute Maximum <sup>[1]</sup>
V <sub>CC</sub>	Supply Voltage, to ground	V	12
P <sub>in</sub>	CW RF Input Power	dBm	+13
T <sub>j</sub>	Junction Temperature	°C	150
T <sub>STG</sub>	Storage Temperature	°C	-65 to 150

### Thermal Resistance<sup>[2]:</sup>

$$\theta_{jc} = 200^{\circ}\text{C/W}$$

#### Notes:

1. Operation of this device above any one of these limits may cause permanent damage.
2. T<sub>C</sub> = 25°C (T<sub>C</sub> is defined to be the temperature at the package pins where contact is made to the circuit board)

## INA-51063 Electrical Specifications<sup>[3]</sup>, T<sub>C</sub> = 25°C, Z<sub>O</sub> = 50 Ω, V<sub>CC</sub> = 5 V

Symbol	Parameters and Test Conditions	Units	Min.	Typ.	Max.
G <sub>p</sub>	Power Gain ( S <sub>21</sub>   <sup>2</sup> ) f = 1500 MHz	dB	18	20.5	
NF	Noise Figure f = 1500 MHz	dB		3	
P <sub>1dB</sub>	Output Power at 1 dB Gain Compression f = 1500 MHz	dBm		-2.5	
IP <sub>3</sub>	Third Order Intercept Point f = 1500 MHz	dBm		+6	
VSWR	Input VSWR f = 1500 MHz			1.3	
	Output VSWR f = 1500 MHz			1.8	
I <sub>cc</sub>	Device Current	mA		12	14
t <sub>d</sub>	Group Delay f = 1500 MHz	ps		240	

## INA-51063 Typical Scattering Parameters<sup>[3]</sup>, T<sub>C</sub> = 25°C, Z<sub>O</sub> = 50 Ω, V<sub>CC</sub> = 5.0 V

Freq. GHz	S <sub>11</sub>		S <sub>21</sub>			S <sub>12</sub>			S <sub>22</sub>		K Factor
	Mag	Ang	dB	Mag	Ang	dB	Mag	Ang	Mag	Ang	
0.05	0.17	177	20.8	10.94	-4	-30.9	0.029	-1	0.23	-5	1.65
0.10	0.17	175	20.8	10.95	-7	-30.8	0.029	-2	0.23	-8	1.65
0.20	0.16	170	20.8	10.94	-14	-30.9	0.028	-4	0.23	-16	1.70
0.30	0.16	166	20.7	10.89	-21	-31.0	0.028	-5	0.23	-25	1.70
0.40	0.14	162	20.8	10.94	-28	-31.2	0.028	-7	0.24	-33	1.69
0.50	0.13	159	20.8	10.96	-35	-31.3	0.027	-9	0.24	-43	1.74
0.60	0.12	158	20.8	11.00	-42	-31.5	0.027	-10	0.24	-52	1.74
0.70	0.10	158	20.9	11.06	-49	-31.6	0.026	-12	0.24	-61	1.79
0.80	0.08	164	20.9	11.06	-57	-31.9	0.026	-14	0.25	-69	1.78
0.90	0.07	172	20.9	11.10	-64	-32.1	0.025	-15	0.26	-77	1.83
1.00	0.07	-174	20.9	11.10	-72	-32.5	0.024	-17	0.26	-85	1.89
1.10	0.07	-156	20.9	11.14	-80	-32.7	0.023	-18	0.27	-94	1.95
1.20	0.08	-142	20.9	11.11	-88	-33.2	0.022	-21	0.27	-103	2.02
1.30	0.10	-135	20.9	11.08	-96	-33.5	0.021	-23	0.28	-113	2.10
1.40	0.12	-131	20.8	11.01	-105	-33.9	0.020	-25	0.28	-122	2.19
1.50	0.14	-131	20.7	10.88	-113	-34.6	0.019	-28	0.28	-131	2.31
1.60	0.17	-132	20.6	10.71	-122	-35.2	0.017	-30	0.28	-140	2.57
1.70	0.19	-134	20.4	10.45	-131	-36.0	0.016	-33	0.28	-150	2.77
1.80	0.22	-135	20.1	10.16	-139	-36.8	0.014	-36	0.27	-159	3.20
1.90	0.24	-139	19.8	9.78	-148	-37.8	0.013	-39	0.27	-168	3.53
2.00	0.26	-142	19.4	9.37	-157	-39.1	0.011	-42	0.25	-177	4.32
2.10	0.28	-145	19.0	8.90	-165	-40.6	0.009	-47	0.24	175	5.49
2.20	0.30	-148	18.5	8.42	-174	-42.2	0.008	-53	0.22	166	6.49
2.30	0.32	-151	18.0	7.96	179	-44.3	0.006	-63	0.21	158	9.03
2.40	0.33	-154	17.4	7.45	171	-46.7	0.005	-79	0.20	150	11.51
2.50	0.35	-157	16.9	6.98	164	-48.9	0.004	-108	0.18	143	15.20
3.00	0.41	-169	13.8	4.89	133	-39.0	0.011	163	0.10	115	7.64
3.50	0.45	-179	10.8	3.48	108	-31.9	0.025	146	0.03	123	4.61
4.00	0.50	172	8.3	2.59	88	-26.9	0.045	132	0.05	-132	3.29

#### Note:

3. Reference plane per Figure 9 in Applications Information section

**INA-51063 Typical Performance,  $T_C = 25^\circ\text{C}$ ,  $Z_O = 50\ \Omega$ ,  $V_{CC} = 5\ \text{V}$**

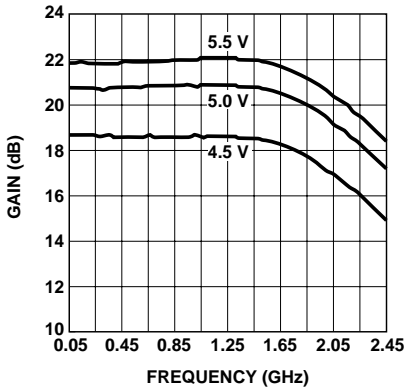

Figure 1. Gain vs. Frequency and Voltage.

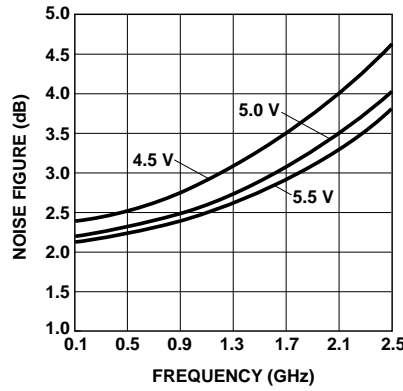

Figure 2. Noise Figure vs. Frequency and Voltage.

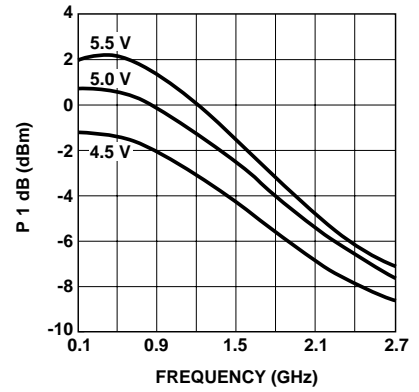

Figure 3. Output Power for 1 dB Gain Compression vs. Frequency and Voltage.

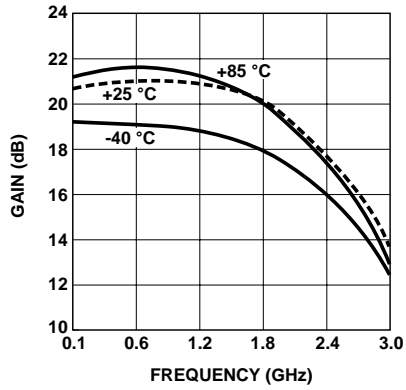

Figure 4. Gain vs. Frequency and Temperature.

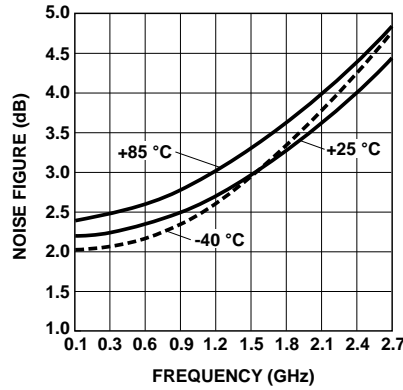

Figure 5. Noise Figure vs. Frequency and Temperature.

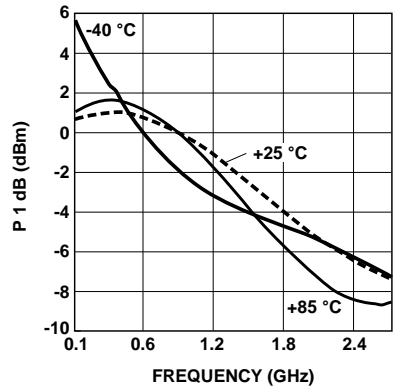

Figure 6. Output Power for 1 dB Gain Compression vs. Frequency and Temperature.

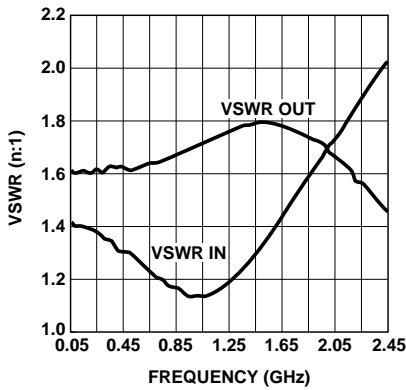

Figure 7. Input and Output VSWR vs. Frequency.

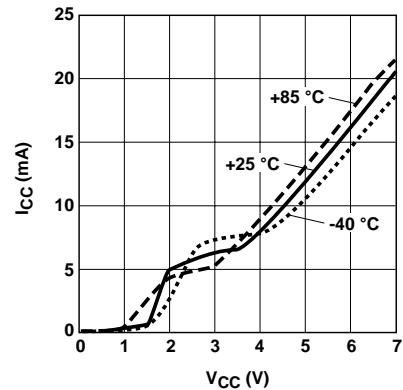

Figure 8. Supply Current vs. Voltage and Temperature.

## INA-51063 Applications Information

### Introduction

The INA-51063 is a silicon RFIC amplifier with a  $50\ \Omega$  input and output. The INA-51063 is easy to use for low noise and multi-purpose gain block applications up to 2.4 GHz.

### Phase Reference Planes

The positions of the reference planes used to measure S-Parameters are shown in Figure 9. As seen in the illustration, the reference planes are located at the point where the package leads contact the test circuit.

### Biasing

The INA-51063 is a voltage biased device and operates from a single +5 volt power supply with a typical current drain of only 12 mA. All bias regulation circuitry is integrated into the RFIC. The supply voltage for the INA-51063 is fed in through the separate  $V_{CC}$  pin of the device and does not require RF isolation from the input or output. No additional external DC components are needed.

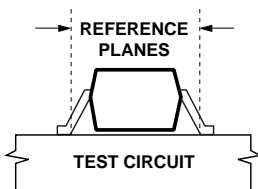

Figure 9. Reference Planes.

### Operating Details

The INA-51063 is very easy to use. The basic application of the INA-51063 is shown in Figure 10.

DC blocking capacitors are placed in series with the RF Input and RF Output to isolate adjacent stages from the internal bias voltages that are present at these terminals. The values of the blocking capacitors are determined by the lowest operating frequency. The values for the blocking capacitors are chosen such that their reactances are small relative to  $50\ \Omega$ . As an example, use of the INA-51063 for a 2.4 GHz application would require blocking capacitors of at least 33 pF.

The  $V_{CC}$  connection to the amplifier must be RF bypassed by placing a capacitor to ground directly at the bias pin of the package. Like the DC blocking capacitors, the value of the  $V_{CC}$  bypass capacitor is determined by the lowest operating frequency for the amplifier. This value may typically be the same as that of the DC blocking capacitors. If long bias lines are used to connect the amplifier to the  $V_{CC}$  supply, additional bypass capacitors may be needed to prevent resonances that would otherwise

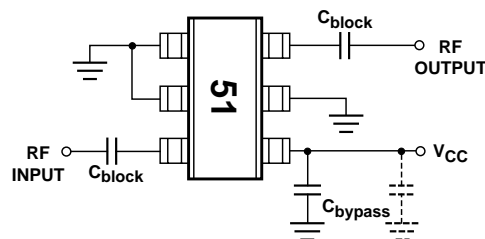

Figure 10. Basic Amplifier Application.

result in undesirable gain responses. A well-bypassed  $V_{CC}$  line is also desirable to prevent possible oscillations that may occur due to feedback through the bias line from other stages in a cascade.

### SOT-363 PCB Layout

The INA-51063 is packaged in the miniature SOT-363 (SC-70) surface mount package. A PCB pad layout for the SOT-363 package is shown in Figure 11 (dimensions are in inches). This layout provides ample allowance for package placement by automated assembly equipment without adding parasitics that could impair the high frequency RF performance of the INA-51063. The layout is shown

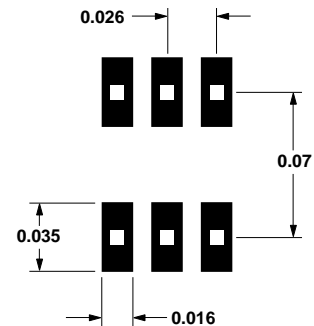

Figure 11. PCB Pad Layout (Dimensions in Inches).

with a nominal SOT-363 package footprint superimposed on the PCB pads.

### RF Layout

The RF layout in Figure 12 is suggested as a starting point for designs using the INA-51063 amplifier. Adequate grounding is needed to obtain maximum performance and to reduce the possibility of potential instability. All three ground pins of the RFIC should be connected to RF

ground by using plated through holes (vias) near the package terminals. The power supply connection to the amplifier must be RF bypassed by placing a capacitor directly to ground at the  $V_{CC}$  pin of the package.

It is recommended that the PCB traces for the ground pins NOT be connected together underneath the body of the package. PCB pads hidden under the package cannot be adequately inspected for SMT solder quality.

FR-4 or G-10 PCB material is a good choice for most low cost wireless applications. Typical board thickness is 0.025 or 0.031 inches. The width of 50  $\Omega$  microstriplines in these PCB thicknesses is also convenient for mounting chip components such as the series inductor at the input for impedance matching or for DC blocking capacitors. For noise figure sensitive applications, the use of PTFE/glass dielectric materials may be warranted to minimize transmission line losses at the amplifier input.

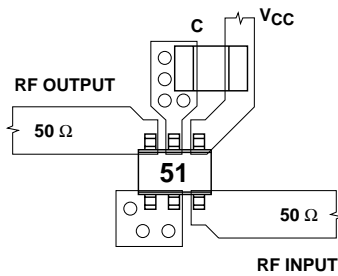

Figure 12. RF Layout.

### INA-51063 Part Number Ordering Information

Part Number	Devices per Container	Container
INA-51063-TR1	3,000	7" reel
INA-51063-BLK	100	Antistatic bag

### Package Dimensions

Outline 63 (SOT-363/SC-70)

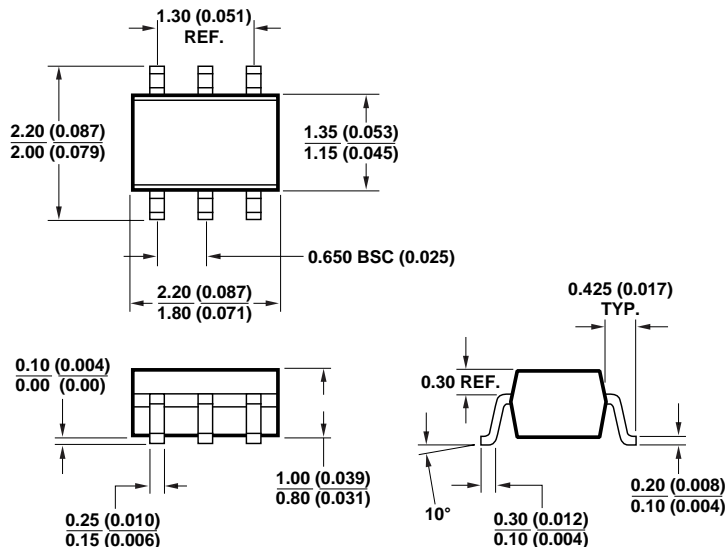

DIMENSIONS ARE IN MILLIMETERS (INCHES)