

International IOR Rectifier

Data Sheet No.PD60144-K

IPS0151(S)

FULLY PROTECTED POWER MOSFET SWITCH

Features

- Over temperature shutdown
- Over current shutdown
- Active clamp
- Low current & logic level input
- E.S.D protection

Description

The IPS0151/IPS0151S are fully protected three terminal SMART POWER MOSFETs that feature over-current, over-temperature, ESD protection and drain to source active clamp. These devices combine a HEXFET® POWER MOSFET and a gate driver. They offer full protection and high reliability required in harsh environments. The driver allows short switching times and provides efficient protection by turning OFF the power MOSFET when the temperature exceeds 165°C or when the drain current reaches 35A. The device restarts once the input is cycled. The avalanche capability is significantly enhanced by the active clamp and covers most inductive load demagnetizations.

Product Summary

$R_{ds(on)}$	25mΩ (max)
V_{clamp}	50V
$I_{shutdown}$	35A
T_{on}/T_{off}	1.5μs

Packages

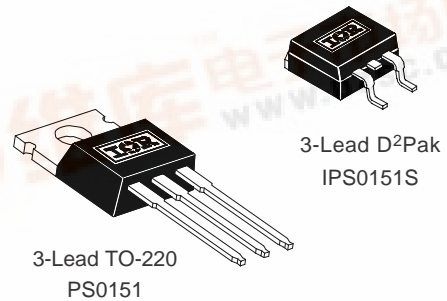

Typical Connection

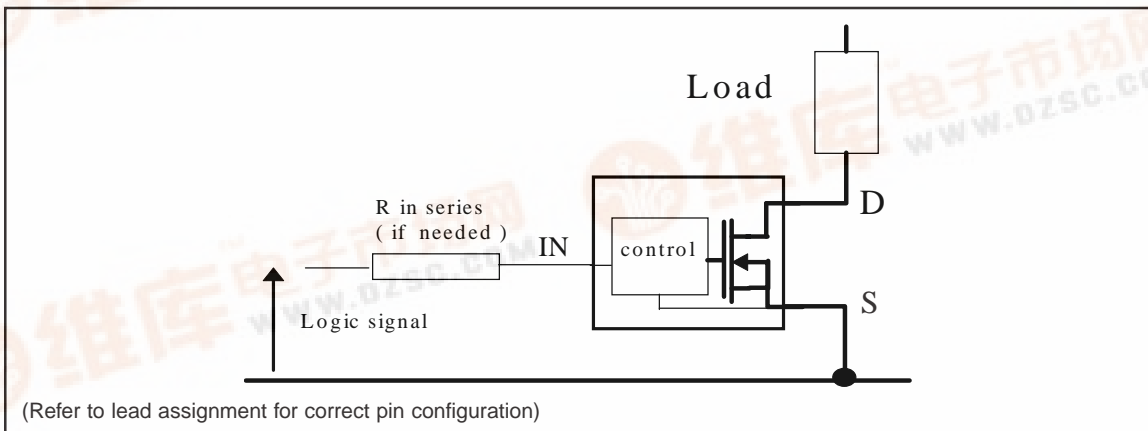

IPS0151(S)

International
IR Rectifier

Absolute Maximum Ratings

Absolute maximum ratings indicate sustained limits beyond which damage to the device may occur. All voltage parameters are referenced to SOURCE lead. ($T_{Ambient} = 25^{\circ}C$ unless otherwise specified). PCB mounting uses the standard footprint with 70 μm copper thickness.

Symbol	Parameter	Min.	Max.	Units	Test Conditions
V_{ds}	Maximum drain to source voltage	—	47	V	
V_{in}	Maximum Input voltage	-0.3	7		
$I_{in, max}$	Maximum IN current	-10	+10	mA	
$I_{sd cont.}$	Diode max. continuous current ⁽¹⁾			A	
	$r_{th}=62^{\circ}C/W$ IPS0151	—	2.8		TO220 free air
	$r_{th}=5^{\circ}C/W$ IPS015135	—	35		TO220 with $R_{th}=5^{\circ}C/W$
	$r_{th}=80^{\circ}C/W$ IPS0151S	—	2.2		SMD220 Std footprint
$I_{sd pulsed}$	Diode max. pulsed current ⁽¹⁾	—	45		
P_d	Maximum power dissipation ⁽¹⁾			W	
	$(r_{th}=62^{\circ}C/W)$ IPS0151	—	2		
	$(r_{th}=80^{\circ}C/W)$ IPS0151S	—	1.56		
ESD1	Electrostatic discharge voltage (Human Body)	—	4	kV	C=100pF, R=1500 Ω ,
ESD2	Electrostatic discharge voltage (Machine Model)	—	0.5		C=200pF, R=0 Ω , L=10 μH
$T_{stor.}$	Max. storage temperature	-55	150	$^{\circ}C$	
$T_j max.$	Max. junction temperature	-40	+150		
T_{lead}	Lead temperature (soldering, 10 seconds)	—	300		

Thermal Characteristics

Symbol	Parameter	Min.	Typ.	Max.	Units	Test Conditions
$R_{th 1}$	Thermal resistance free air	—	55	—	$^{\circ}C/W$	TO-220
$R_{th 2}$	Thermal resistance junction to case	—	2	—		
$R_{th 1}$	Thermal resistance with standard footprint	—	60	—		D ² PAK (SMD220)
$R_{th 2}$	Thermal resistance with 1" square footprint	—	35	—		
$R_{th 3}$	Thermal resistance junction to case	—	2	—		

Recommended Operating Conditions

These values are given for a quick design. For operation outside these conditions, please consult the application notes.

Symbol	Parameter	Min.	Max.	Units
$V_{ds (max)}$	Continuous drain to source voltage	—	35	V
V_{IH}	High level input voltage	4	6	
V_{IL}	Low level input voltage	0	0.5	
I_{ds} $T_{amb}=85^{\circ}C$	Continuous drain current			A
	$(T_{Ambient} = 85^{\circ}C, I_N = 5V, r_{th} = 60^{\circ}C/W, T_j = 125^{\circ}C)$ IPS0151	—	4.3	
	$(T_{Ambient} = 85^{\circ}C, I_N = 5V, r_{th} = 80^{\circ}C/W, T_j = 125^{\circ}C)$ IPS0151S	—	3.8	
R_{in}	Recommended resistor in series with IN pin	0.2	5	k Ω
$T_r-in (max)$	Max recommended rise time for IN signal (see fig. 2)	—	1	μS
$f_r-lsc^{(2)}$	Max. frequency in short circuit condition ($V_{cc} = 14V$)	0	1	kHz

(1) Limited by junction temperature (pulsed current limited also by internal wiring)

(2) Operations at higher switching frequencies is possible. See Application Notes.

Static Electrical Characteristics

(T_j = 25°C unless otherwise specified.)

Symbol	Parameter	Min.	Typ.	Max.	Units	Test Conditions	
R _{ds(on)}	ON state resistance	T _j = 25°C	10	20	25	mΩ	V _{in} = 5V, I _{ds} = 1A
		T _j = 150°C	—	35	45		
I _{dss1} @T _j =25°C	Drain to source leakage current	0	0.5	25	μA	V _{CC} = 14V, T _j = 25°C	
I _{dss2} @T _j =25°C	Drain to source leakage current	0	5	50		V _{CC} = 40V, T _j = 25°C	
V clamp 1	Drain to source clamp voltage 1	47	52	56	V	I _d = 20mA (see Fig.3 & 4)	
V clamp 2	Drain to source clamp voltage 2	50	55	60		I _d =I _{shutdown} (see Fig.3 & 4)	
V _{in clamp}	IN to source clamp voltage	7	8.1	9.5		I _{in} = 1 mA	
V _{in th}	IN threshold voltage	1	1.6	2		I _d = 50mA, V _{ds} = 14V	
I _{in, -on}	ON state IN positive current	25	90	200	μA	V _{in} = 5V	
I _{in, -off}	OFF state IN positive current	50	130	250		V _{in} = 5V over-current triggered	

Switching Electrical Characteristics

V_{CC} = 14V, Resistive Load = 3Ω, R_{input} = 50Ω, 100μs pulse, T_j = 25°C, (unless otherwise specified).

Symbol	Parameter	Min.	Typ.	Max.	Units	Test Conditions
T _{on}	Turn-on delay time	0.05	0.25	0.6	μs	See figure 2
T _r	Rise time	0.2	0.9	1.5		
T _{rf}	Time to (final R _{ds(on)} 1.3%)	—	3.8	—		
T _{off}	Turn-off delay time	0.8	1.5	2		See figure 2
T _f	Fall time	0.4	1.1	2		
Q _{in}	Total gate charge	—	30	—	nC	V _{in} = 5V

Protection Characteristics

Symbol	Parameter	Min.	Typ.	Max.	Units	Test Conditions
T _{sd}	Over temperature threshold	—	165	—	°C	See fig. 1
I _{sd}	Over current threshold	20	35	50	A	See fig. 1
V _{reset}	IN protection reset threshold	1.5	2.3	3	V	
T _{reset}	Time to reset protection	2	10	40	μs	V _{in} = 0V, T _j = 25°C
EOI_OT	Short circuit energy (see application note)	—	400	—	μJ	V _{CC} = 14V

IPS0151(S)

International
IR Rectifier

Functional Block Diagram

All values are typical

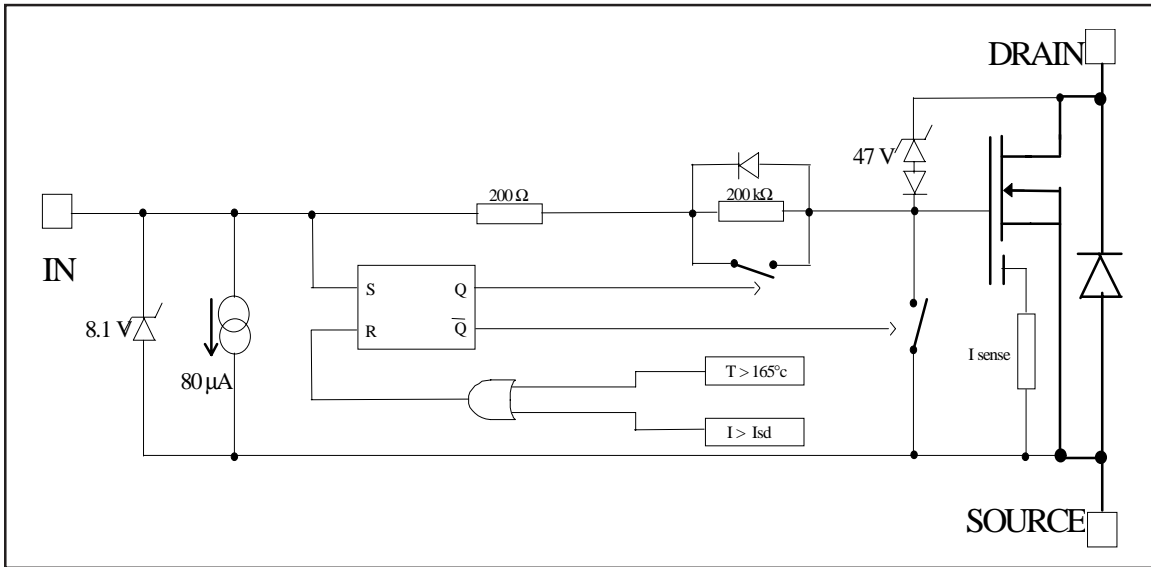

Lead Assignments

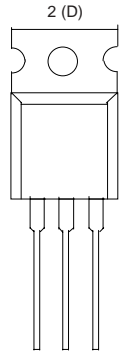
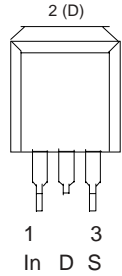
 <p>2 (D)</p> <p>1 2 3 In D S</p> <p>TO-220</p>	 <p>2 (D)</p> <p>1 3 In D S</p> <p>D²PAK (SMD220)</p>
IPS0151	IPS0151S
Part Number	

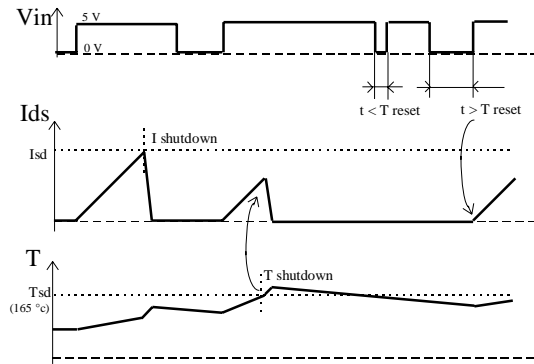

Figure 1 - Timing diagram

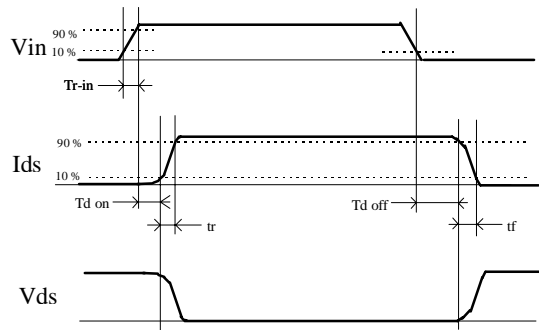

Figure 2 - IN rise time & switching time definitions

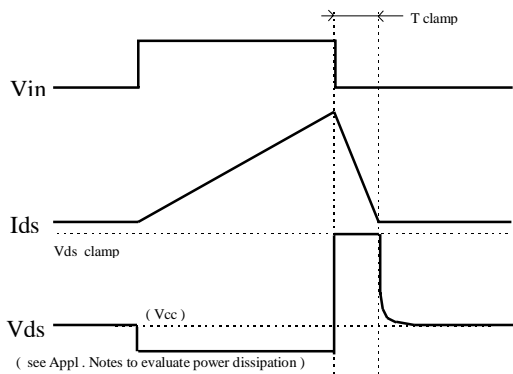

Figure 3 - Active clamp waveforms

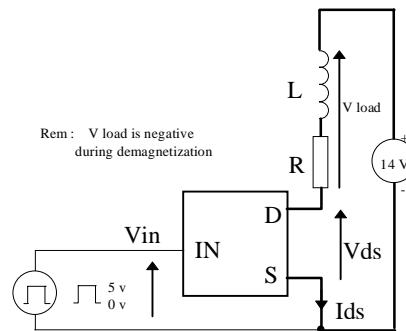

Figure 4 - Active clamp test circuit

IPS0151(S)

All curves are typical values with standard footprints. Operating in the shaded area is not recommended.

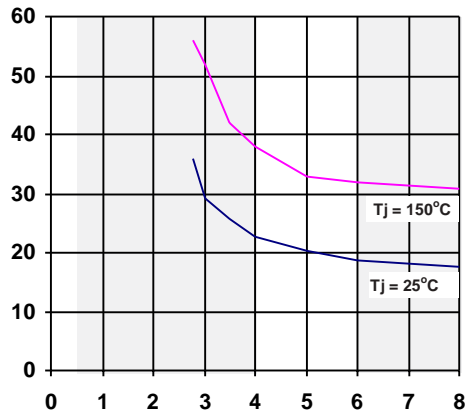

Figure 5 - Rds ON (mΩ) Vs Input Voltage (V)

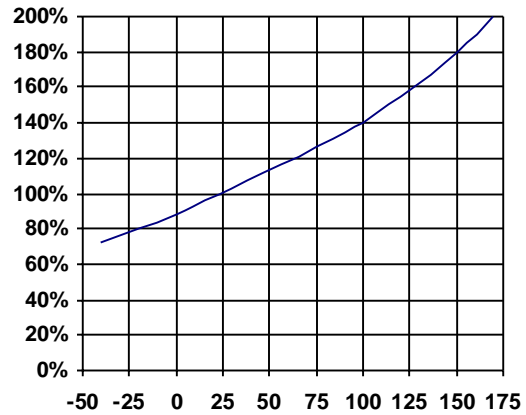

Figure 6 - Normalised Rds ON (%) Vs Tj (°C)

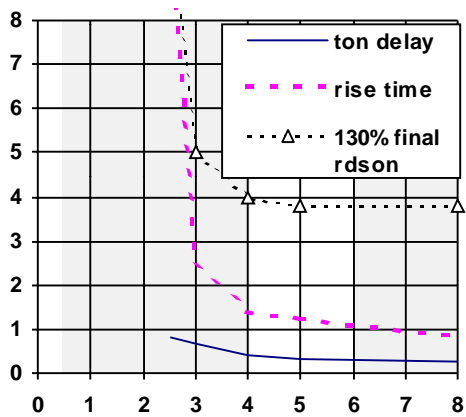

Figure 7 - Turn-ON Delay Time, Rise Time & Time to 130% final Rds(on) (us) Vs Input Voltage (V)

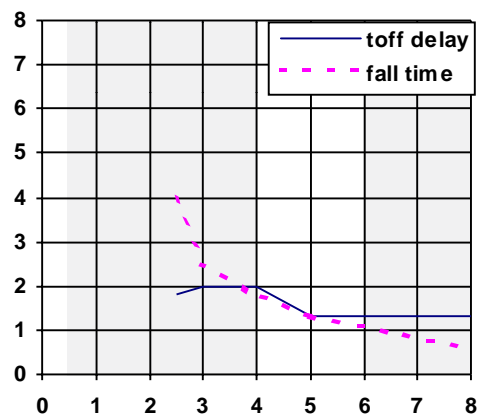

Figure 8 - Turn-OFF Delay Time & Fall Time (us) Vs Input Voltage (V)

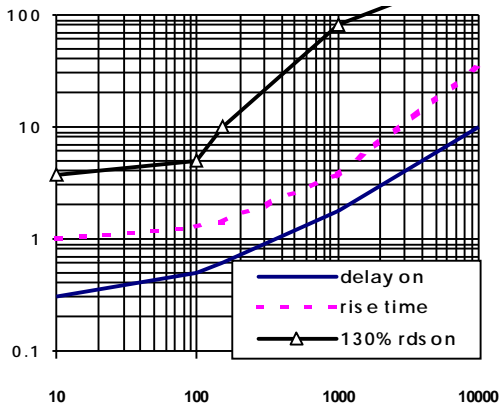

Figure 9 - Turn-ON Delay Time, Rise Time & Time to 130% final $R_{ds(on)}$ (us) Vs IN Resistor (Ω)

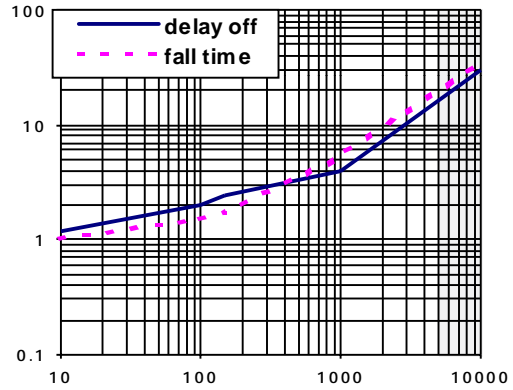

Figure 10 - Turn-OFF Delay Time & Fall Time (us) Vs IN Resistor (Ω)

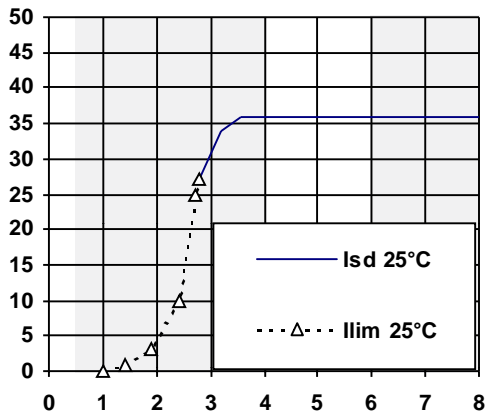

Figure 11 - Current lim. & $I_{shutdown}$ (A) Vs V_{in} (V)

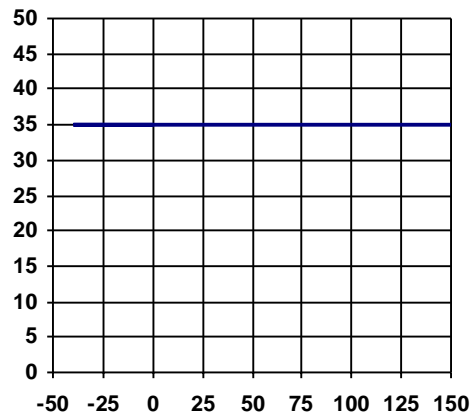

Figure 12 - $I_{shutdown}$ (A) Vs Temperature ($^{\circ}C$)

IPS0151(S)

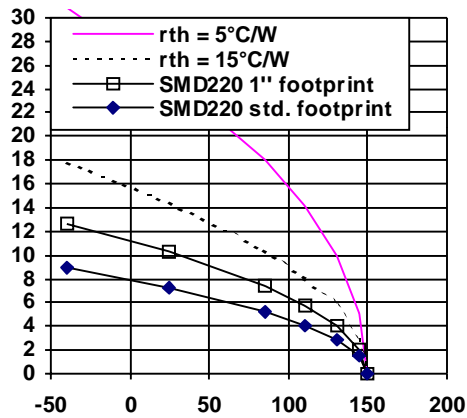

Figure 13 - Max.Cont. Ids (A) Vs Ambient Temperature ($^{\circ}\text{C}$)

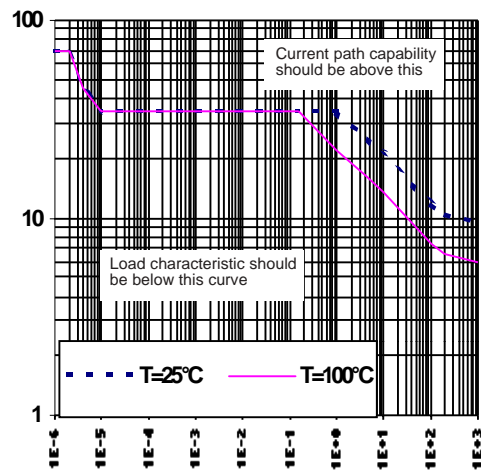

Figure 14 - Max.Cont. Ids (A) Vs Ambient Temperature ($^{\circ}\text{C}$)

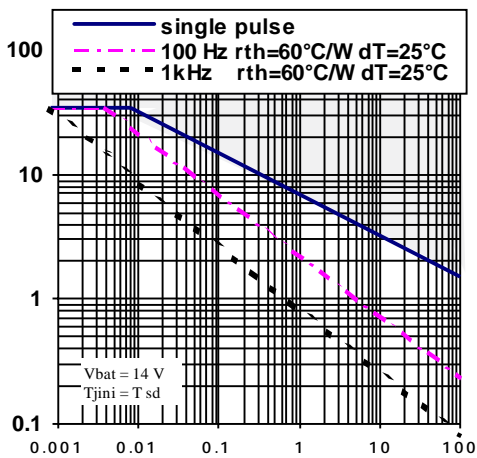

Figure 15 - I_{clamp} (A) Vs Inductive Load (mH)

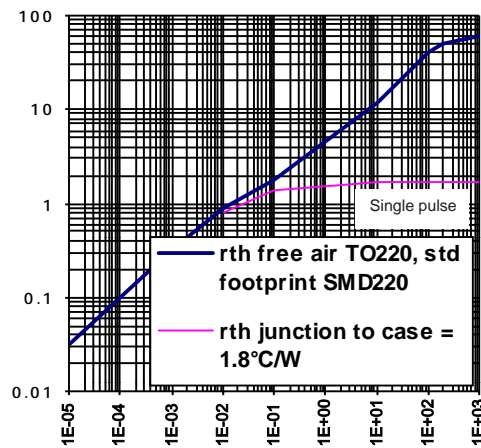

Figure 16 - Transient Thermal Imped. ($^{\circ}\text{C/W}$) Vs Time (s) - IPS0151/IPS0151S

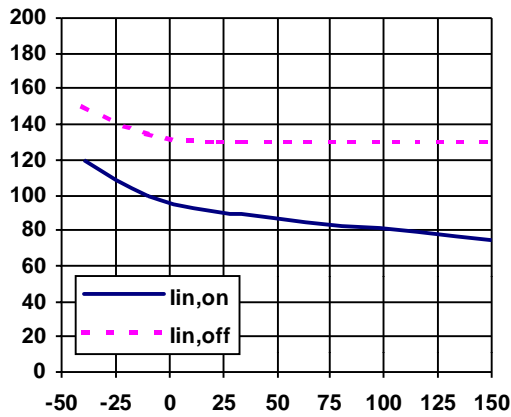

Figure 17 - Input current (μA) Vs Junction ($^{\circ}\text{C}$)

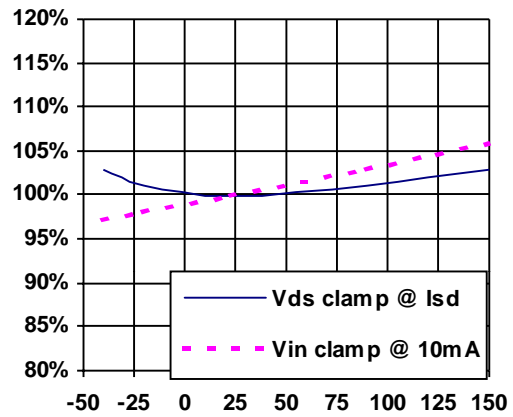

Figure 18 - Vin clamp and V clamp2 (V) Vs Tjunction ($^{\circ}\text{C}$)

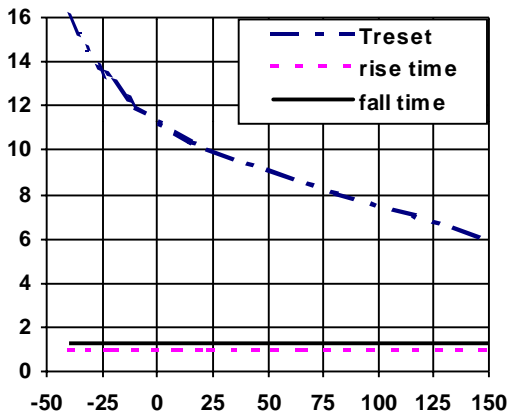
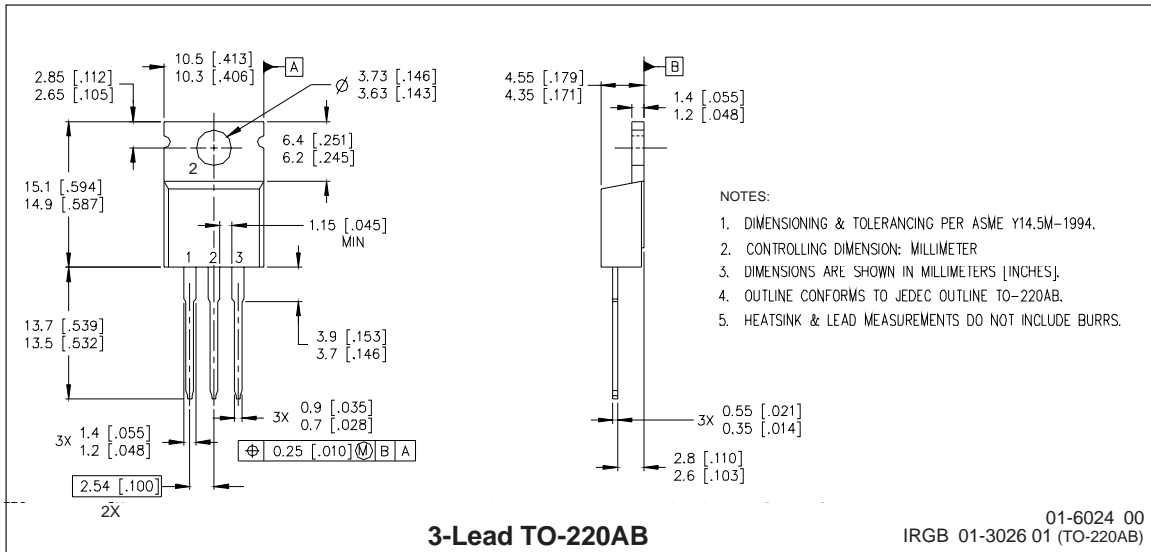

Figure 19 - Turn-on, Turn-off, and Treset (μs) Vs Tjunction ($^{\circ}\text{C}$)

IPS0151(S)

International
IR Rectifier

Case Outline



Case Outline

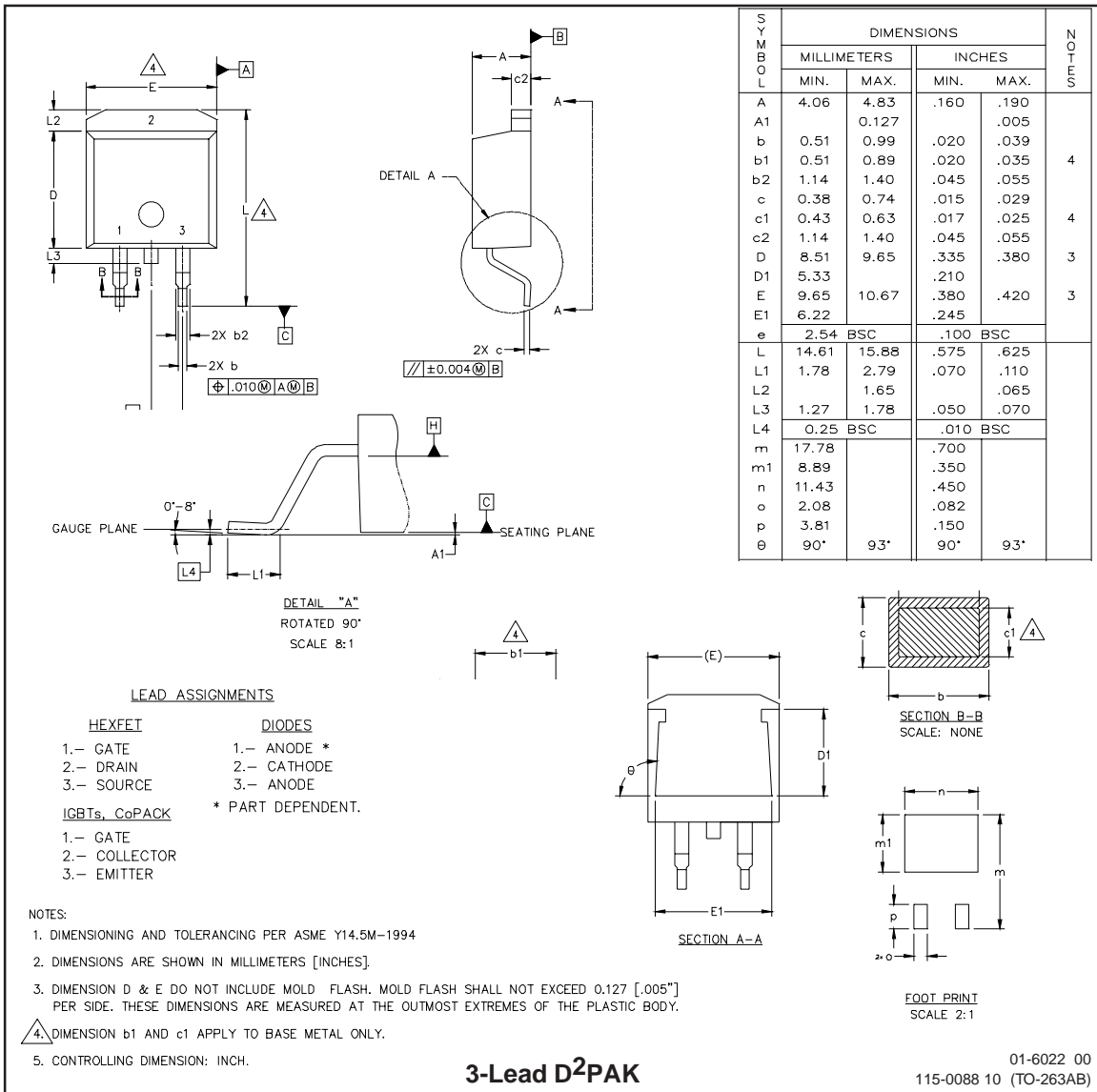

SYMBOL	DIMENSIONS				NOTES
	MILLIMETERS		INCHES		
	MIN.	MAX.	MIN.	MAX.	
A	4.06	4.83	.160	.190	4
A1		0.127		.005	
b	0.51	0.99	.020	.039	
b1	0.51	0.89	.020	.035	
b2	1.14	1.40	.045	.055	4
c	0.38	0.74	.015	.029	
c1	0.43	0.63	.017	.025	
c2	1.14	1.40	.045	.055	
D	8.51	9.65	.335	.380	3
D1	5.33		.210		
E	9.65	10.67	.380	.420	3
E1	6.22		.245		
e	2.54 BSC		.100 BSC		
L	14.61	15.88	.575	.625	
L1	1.78	2.79	.070	.110	
L2		1.65		.065	
L3	1.27	1.78	.050	.070	
L4	0.25 BSC		.010 BSC		
m	17.78		.700		
m1	8.89		.350		
n	11.43		.450		
o	2.08		.082		
p	3.81		.150		
θ	90°	93°	90°	93°	

IPS0151(S)

International
IR Rectifier

Tape & Reel - D²PAK (SMD220)

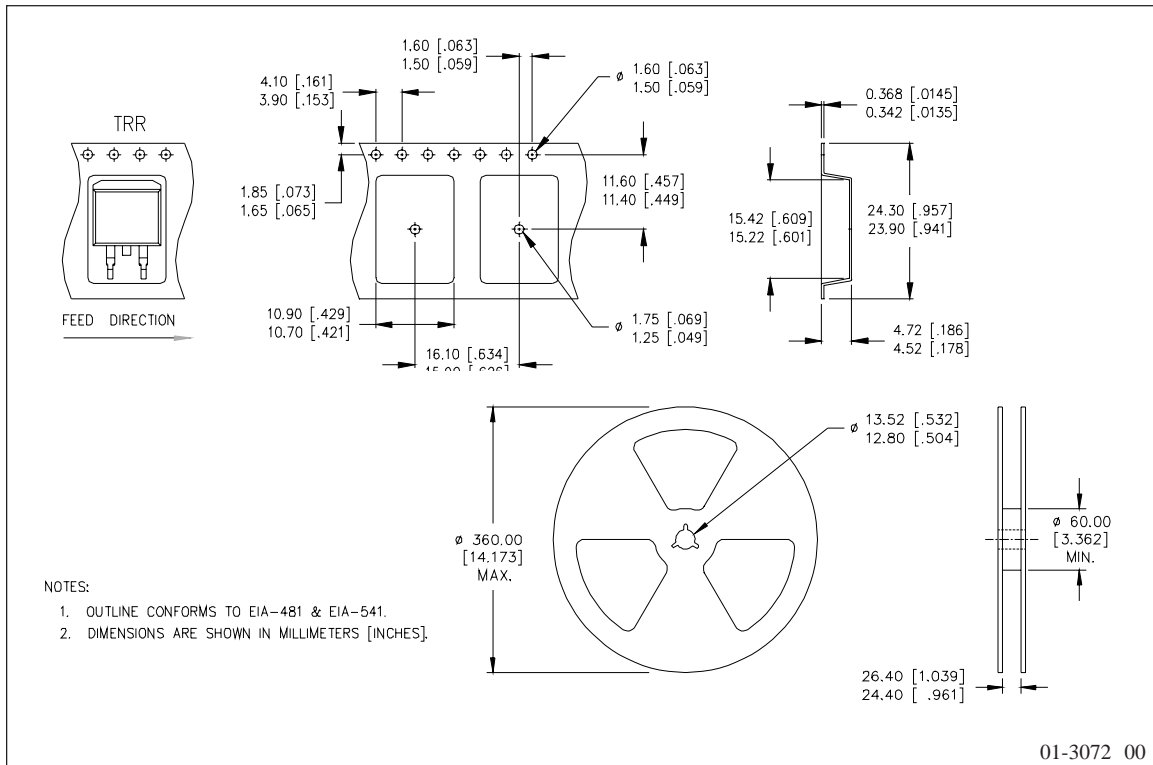

International
IR Rectifier

IR WORLD HEADQUARTERS: 233 Kansas St., El Segundo, California 90245 Tel: (310) 252-7105
Data and specifications subject to change without notice. 11/13/2001