

International IOR Rectifier

Data Sheet No.PD60159-J

IPS5451/IPS5451S

FULLY PROTECTED HIGH SIDE POWER MOSFET SWITCH

Features

- Over temperature protection (with auto-restart)
- Over current shutdown
- Active clamp
- E.S.D protection
- Status feedback
- Open load detection
- Logic ground isolated from power ground

Description

The IPS5451/IPS5451S are fully protected five terminal high side switch with built in short circuit, over-temperature, ESD protection, inductive load capability and diagnostic feedback. The over-current protection latches off the device if the output current exceeds Ishutdown. It can be reset by turning the input pin low. The over-temperature protection turns off the high side switches if the junction temperature exceeds Tshutdown. It will automatically restart after the junction has cooled 7°C below Tshutdown. A diagnostic pin is provided for status feedback of over-current, over-temperature and open load detection. The double level shifter circuitry allows large offsets between the logic ground and the load ground.

Product Summary

R _{ds(on)}	25mΩ (max)
V _{clamp}	50V
I _{shutdown}	35A
I _{open load}	1A

Truth Table

Op. Conditions	In	Out	Dg
Normal	H	H	H
Normal	L	L	H
Open load	H	H	L
Open load	L	X	H
Over current	H	L (latched)	L
Over current	L	L	H
Over-temperature	H	L (cycling)	L (cycling)
Over-temperature	L	L	H

Typical Connection

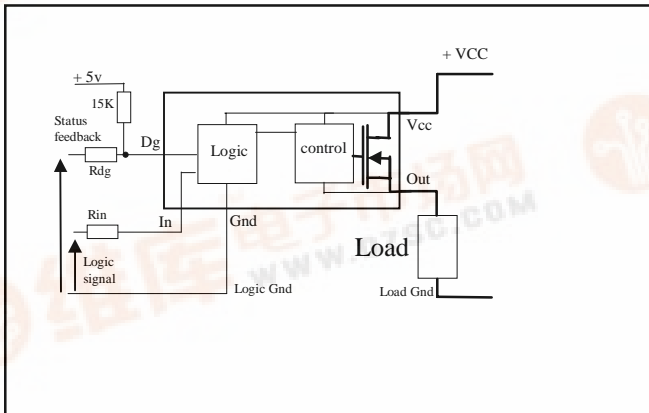

Packages

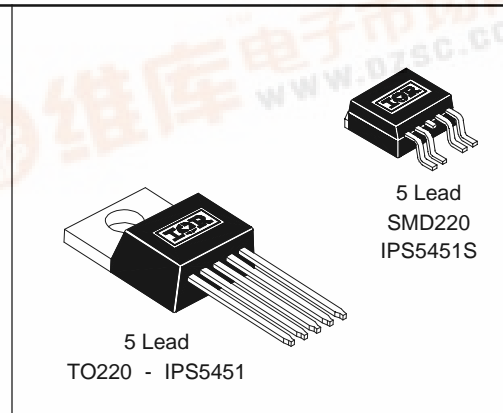

IPS5451/IPS5451S

International
IR Rectifier

Absolute Maximum Ratings

Absolute maximum ratings indicate sustained limits beyond which damage to the device may occur. All voltage parameters are referenced to GROUND lead. (T_{Ambient} = 25°C unless otherwise specified).

Symbol	Parameter	Min.	Max.	Units	Test Conditions
V _{out}	Maximum output voltage	V _{CC} -45	V _{CC} +0.3	V	
V _{offset}	Maximum logic ground to load ground offset	V _{CC} -45	V _{CC} +0.3		
V _{in}	Maximum Input voltage	-0.3	5.5		
I _{in, max}	Maximum IN current	-5	10	mA	
V _{dg}	Maximum diagnostic output voltage	-0.3	5.5	V	
I _{dg, max}	Maximum diagnostic output current	-1	10	mA	
I _{sd cont.}	Diode max. continuous current ⁽¹⁾ (r _{th} =62°C/W) IPS5451 (r _{th} =80°C/W) IPS5451S	—	2.8	A	
		—	2.2		
		—	45		
I _{sd pulsed}	Diode max. pulsed current ⁽¹⁾	—	45		
ESD1	Electrostatic discharge voltage (Human Body)	—	4	kV	C=100pF, R=1500Ω,
ESD2	Electrostatic discharge voltage (Machine Model)	—	0.5		C=200pF, R=0Ω, L=10μH
P _d	Maximum power dissipation ⁽¹⁾ (r _{th} =62°C/W) IPS5451 (r _{th} =80°C/W) IPS5451S	—	2	W	
		—	1.56		
		—	—		
T _{j max.}	Max. storage & operating junction temp.	-40	+150	°C	
T _{lead}	Lead temperature (soldering 10 seconds)	—	300		
V _{cc max.}	Maximum V _{cc} voltage	—	45	V	

Thermal Characteristics

Symbol	Parameter	Min.	Typ.	Max.	Units	Test Conditions
R _{th 1}	Thermal resistance junction to case	—	2	—	°C/W	TO-220
R _{th 2}	Thermal resistance junction to ambient	—	55	—		
R _{th 1}	Thermal resistance with standard footprint	—	60	—		D ² PAK (SMD220)
R _{th 2}	Thermal resistance with 1" square footprint	—	35	—		
R _{th 3}	Thermal resistance junction to case	—	5	—		

(1) Limited by junction temperature (pulsed current limited also by internal wiring)

Recommended Operating Conditions

These values are given for a quick design. For operation outside these conditions, please consult the application notes.

Symbol	Parameter	Min.	Max.	Units
V _{CC}	Continuous V _{CC} voltage	5.5	18	V
V _{IH}	High level input voltage	4	5.5	
V _{IL 1}	Low level input voltage	-0.3	0.9	
I _{out}	Continuous output current (T _{Ambient} = 85°C, T _j = 125°C, R _{th} = 62°C/W) IPS5451 (T _{Ambient} = 85°C, T _j = 125°C, R _{th} = 80°C/W) IPS5451S	—	4 3.5	A
I _{out} T _c =85°C	Continuous output current (T _{Case} = 85°C, I _N = 5V, T _j = 125°C, R _{th} = 5°C/W)	—	14	
R _{in}	Recommended resistor in series with IN pin	4	6	kΩ
R _{dg}	Recommended resistor in series with DG pin	10	20	

Static Electrical Characteristics

(T_j = 25°C, V_{CC} = 14V unless otherwise specified.)

Symbol	Parameter	Min.	Typ.	Max.	Units	Test Conditions
R _{ds(on)} @T _j =25°C	ON state resistance T _j = 25°C	—	19	25	mΩ	V _{in} = 5V, I _{out} = 14A
R _{ds(on)} (V _{CC} =6V)	ON state resistance @ V _{CC} = 6V	—	22	30		V _{in} = 5V, I _{out} = 7A
R _{ds(on)} @T _j =150°C	ON state resistance T _j = 150°C	—	32	—		V _{in} = 5V, I _{out} = 14A
V _{CC oper.}	Functional operating range	5.5	—	35	V	
V _{clamp 1}	V _{CC} to OUT clamp voltage 1	45	49	—		I _d = 10mA (see Fig.1 & 2)
V _{clamp 2}	V _{CC} to OUT clamp voltage 2	—	50	60		I _d = I _{shutdown} (see Fig.1 & 2)
V _f	Body diode forward voltage	—	0.9	1.2	μA	I _d = 14A, V _{in} = 0V
I _{out leakage}	Output leakage current	—	10	50		V _{out} = 0V, T _j = 25°C
I _{CC off}	Supply current when OFF	—	3.5	50		V _{in} = 0V, V _{out} = 0V
I _{CC on}	Supply current when ON	—	3.5	10	μA	V _{in} = 5V
I _{CC ac}	Ripple current when ON (AC RMS)	—	20	—		V _{in} = 5V
V _{dgl}	Low level diagnostic output voltage	—	0.1	0.4	V	I _{dg} = 1.6 mA
I _{dg leakage}	Diagnostic output leakage current	—	1.5	10	μA	V _{dg} = 4.5V
V _{Ih}	IN high threshold voltage	—	2.7	3.4	V	
V _{Il}	IN low threshold voltage	1	2.0	—		
I _{in, on}	On state IN positive current	—	30	80	μA	V _{in} = 4V
V _{CCuv+}	V _{CC} UVLO positive going threshold	—	4.7	5.5	V	
V _{CCuv-}	V _{CC} UVLO negative going threshold	3.0	4.4	—		
I _{nhyst.}	Input hysteresis	0.2	0.6	1.5		

IPS5451/IPS5451S

International
IR Rectifier

Switching Electrical Characteristics

$V_{CC} = 14V$, Resistive Load = 1Ω , $T_j = 25^\circ C$, (unless otherwise specified).

Symbol	Parameter	Min.	Typ.	Max.	Units	Test Conditions
T_{don}	Turn-on delay time	—	5	20	μs	See figure 3
T_{r1}	Rise time to $V_{out} = V_{CC} - 5V$	—	4	20		
T_{r2}	Rise time from the end of T_{r1} to $V_{out} = 90\%$ of V_{CC}	—	65	150		
dV/dt (on)	Turn ON dV/dt	—	3	6	$V/\mu s$	See figure 4
E_{on}	Turn ON energy	—	3	—	mJ	
T_{doff}	Turn-off delay time	—	65	150	μs	
T_f	Fall time to $V_{out} = 10\%$ of V_{CC}	—	8	20	μs	
dV/dt (off)	Turn OFF dV/dt	—	5	10	$V/\mu s$	
E_{off}	Turn OFF energy	—	0.75	—	mJ	

Protection Characteristics

Symbol	Parameter	Min.	Typ.	Max.	Units	Test Conditions
T_{sd+}	Over-temp. positive going threshold	—	165	—	$^\circ C$	See fig. 2
T_{sd-}	Over-temp. negative going threshold	—	158	—	$^\circ C$	See fig. 2
I_{sd}	Over-current threshold	22	35	50	A	See fig. 2
$I_{open\ load}$	Open load detection threshold	0.3	1	2	A	
T_{reset}	Minimum time to reset protections	—	50	—	μs	$V_{in} = 0V$
T_{dg}	Blanking time before considering Dg	—	7	100	μs	Part turned on with $V_{in} = 5V$

Functional Block Diagram

All values are typical

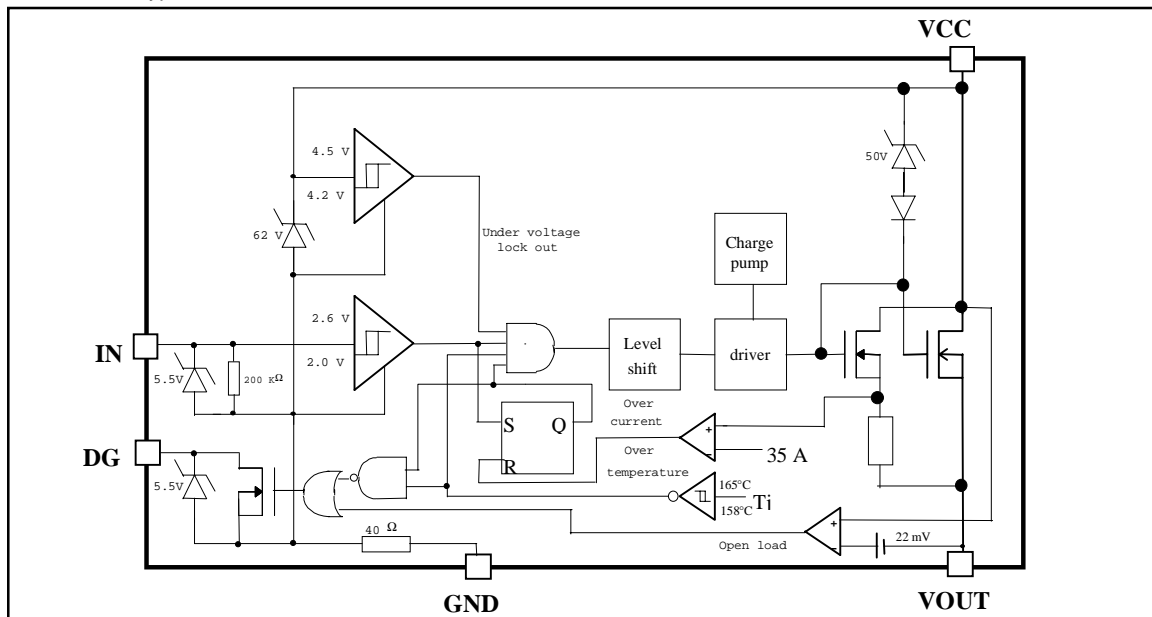

Lead Assignments

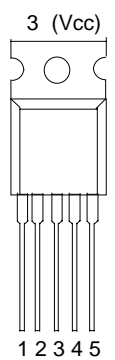
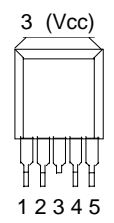
 <p>3 (Vcc)</p> <p>1 2 3 4 5</p> <p>5 Lead - TO220</p>	<p>1 - Ground 2 - In 3 - Vcc 4 - DG 5 - Out</p>	 <p>3 (Vcc)</p> <p>1 2 3 4 5</p> <p>5 Lead - D²PAK (SMD220)</p>
IPS5451		IPS5451S
Part Number		

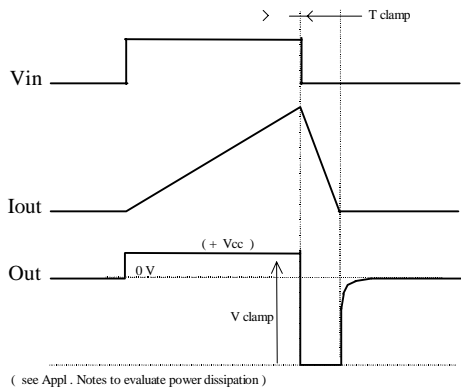

Figure 1 - Active clamp waveforms

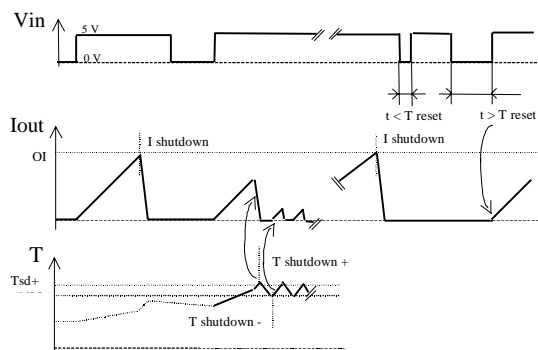

Figure 2 - Protection timing diagram

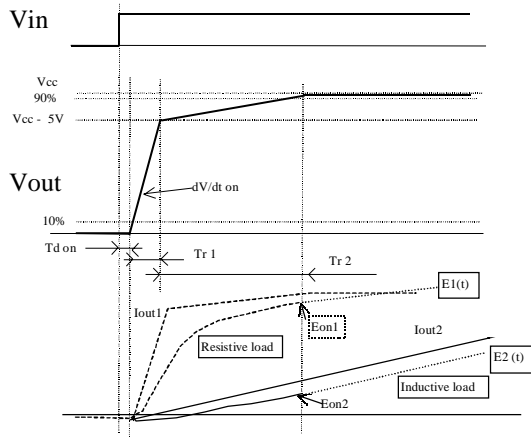

Figure 3 - Switching times definition (turn-on)
Turn on energy with a resistive or an inductive load

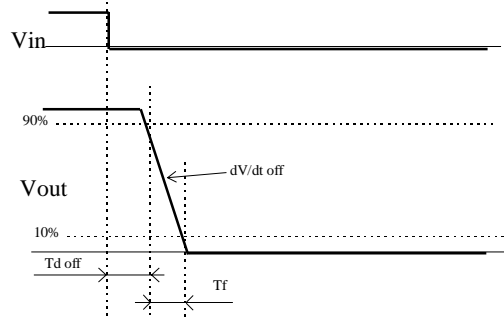

Figure 4 - Switching times definition (turn-off)

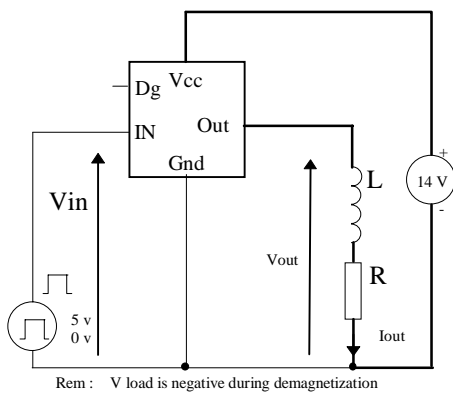

Figure 5 - Active clamp test circuit

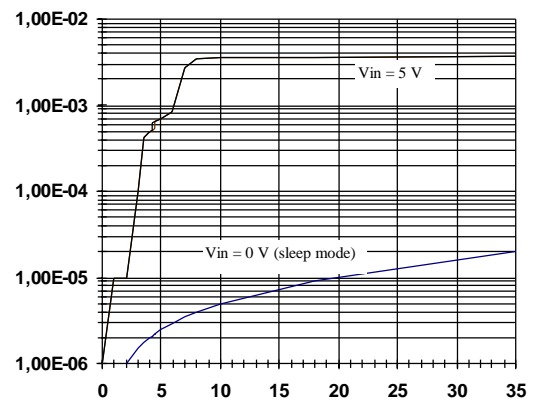

Figure 6 - I_{cc} (mA) Vs V_{cc} (V)

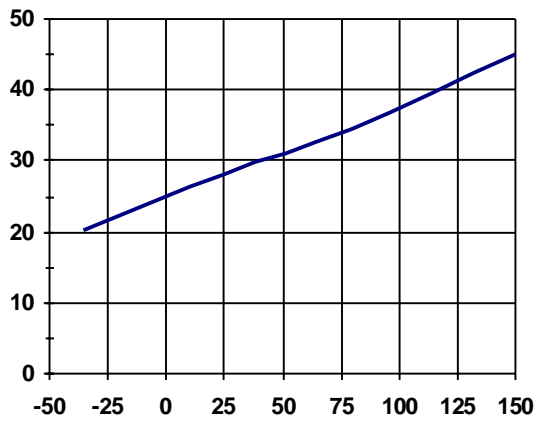

Figure 7 - I_{in} (μA) Vs T_j (°C)

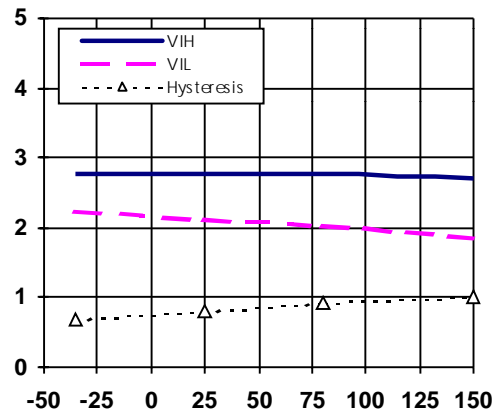

Figure 8 - V_{IH}, V_{IL} threshold (V) Vs T_j (°C)

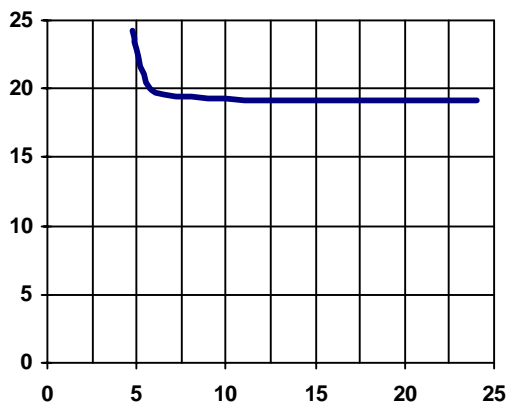

Figure 9 - R_{dson} (mΩ) vs V_{cc} (V)

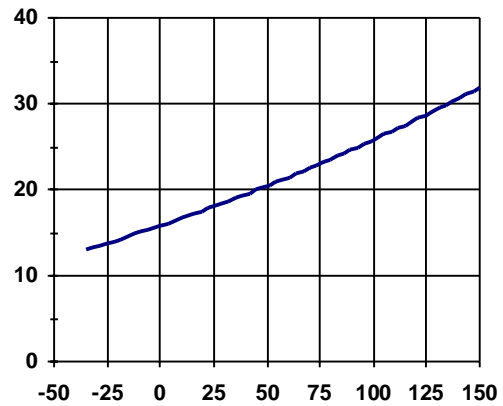

Figure 10 - R_{dson} (mΩ) vs T_j (°C)

IPS5451/IPS5451S

International
IR Rectifier

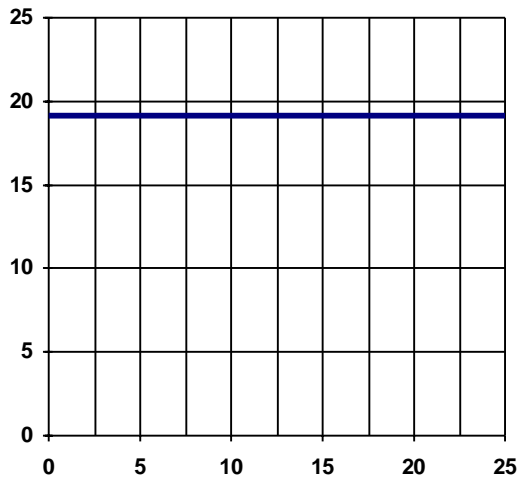

Figure 11 - R_{dson} (m Ω) vs I_{out} (A)

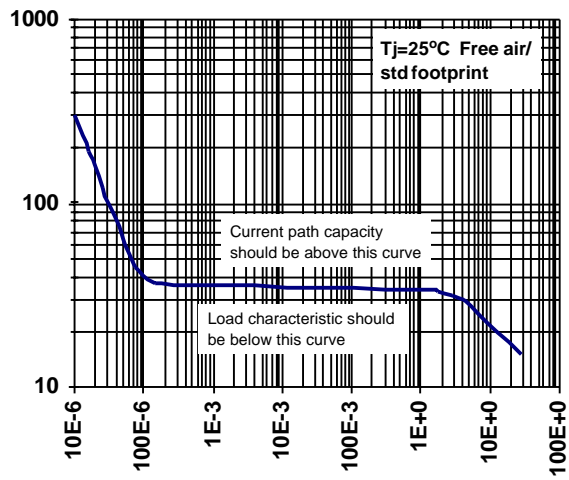

Figure 12 - I_{sd} (A) vs Time (S)

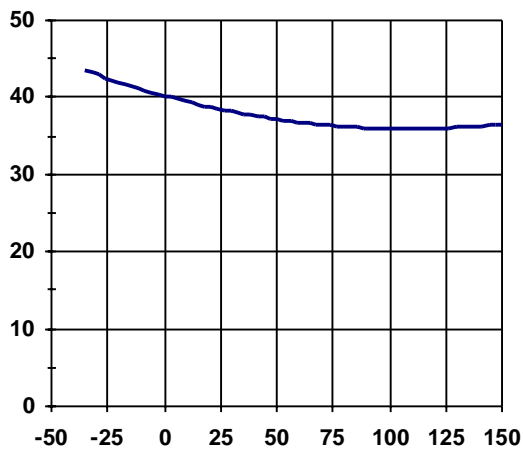

Figure 13 - I_{sd} (A) vs T_j (°C)

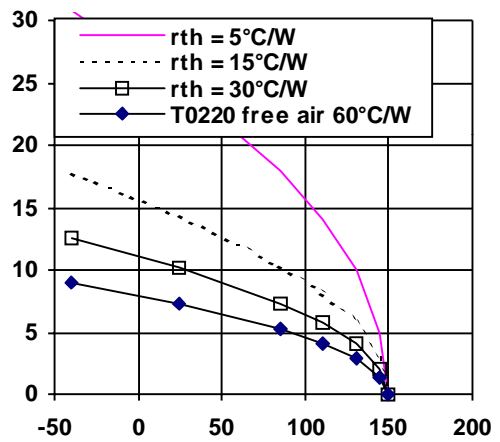

Figure 14 - Max. Cont. I_{ds} (A) Vs Amb. Temperature (°C)

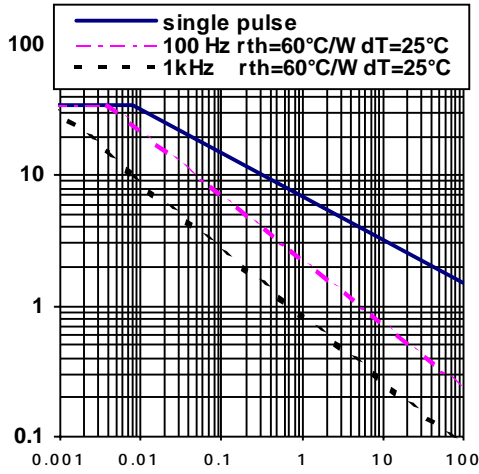

Figure 15 -Max. I clamp (A) Vs Inductive Load (m H)

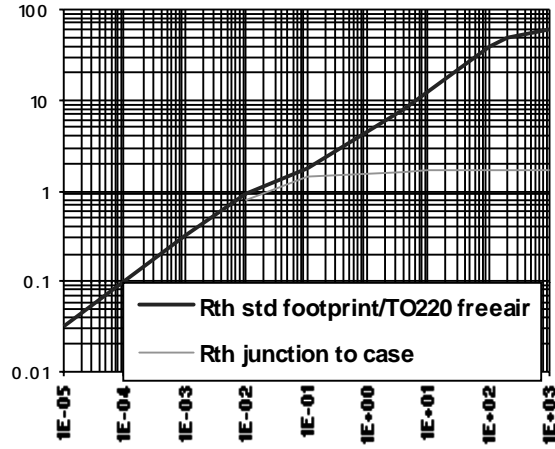

Figure 16 - Transient Rth (°C/W) Vs Time (s)

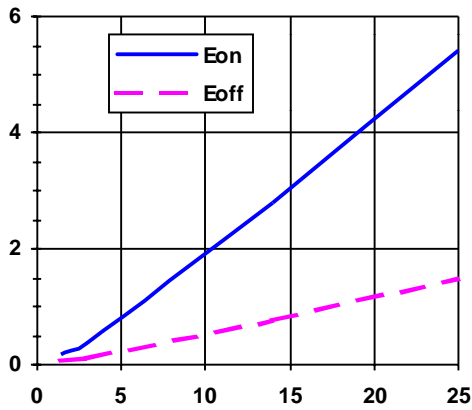

Figure 17 - Eon, Eoff (mJ) vs Iout (A)

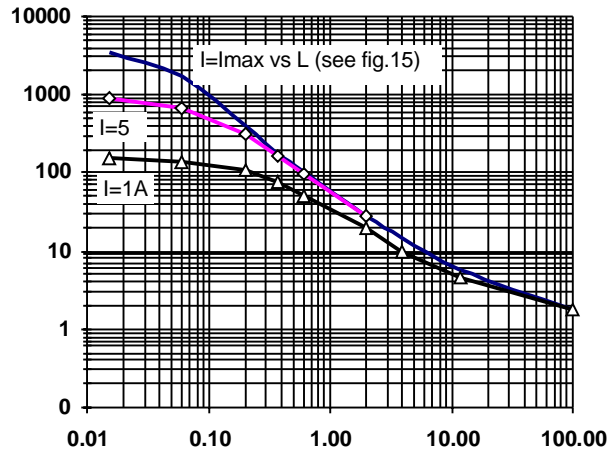

Figure 18 - Eon @ Vcc=14V (mJ) vs Inductance (mH)

IPS5451/IPS5451S

International
IR Rectifier

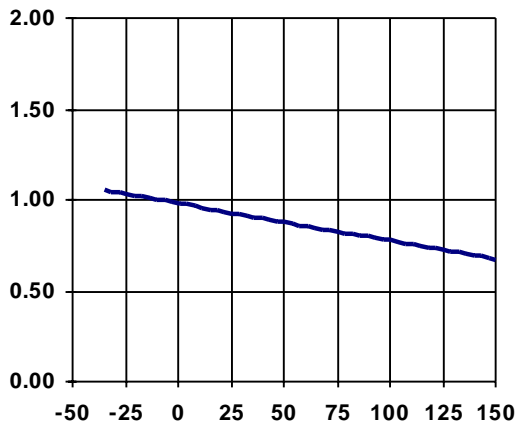

Figure 19 - I open load (A) vs Tj (°C)

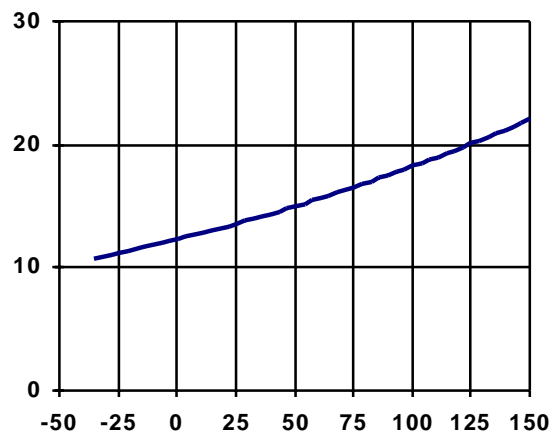
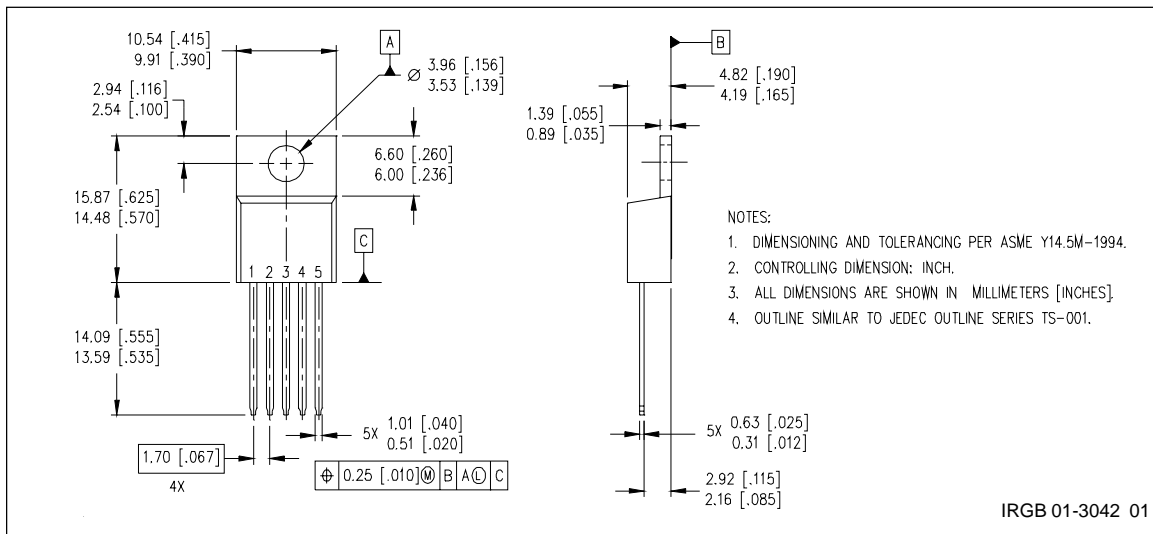
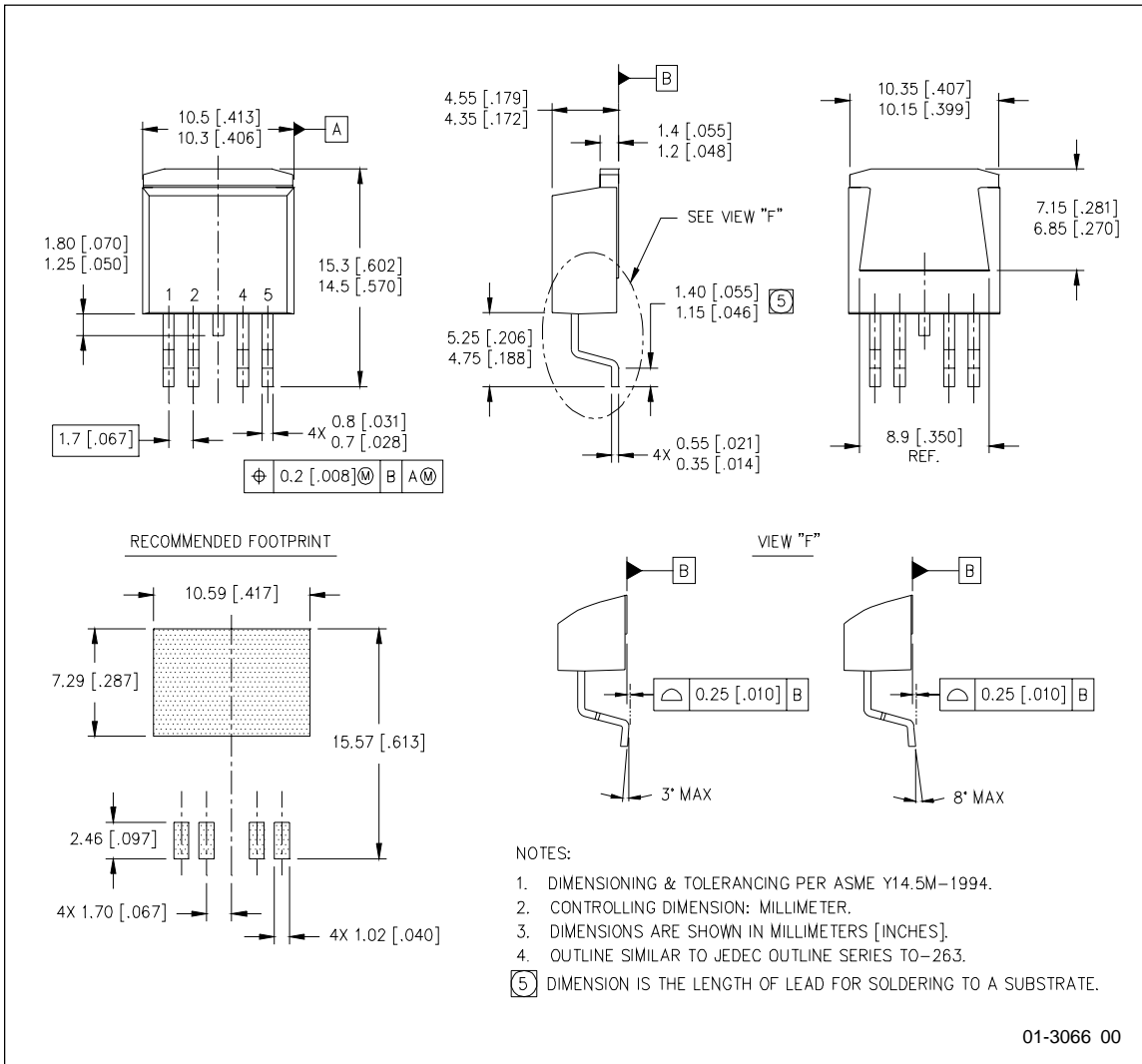

Figure 20 - Iqc (µA) vs Tj (°C)

Case Outline - TO220 (5 lead)



Case Outline - D²PAK (SMD220) - 5 Lead



IPS5451/IPS5451S

International
IR Rectifier

Tape & Reel - D²PAK (SMD220) - 5 Lead

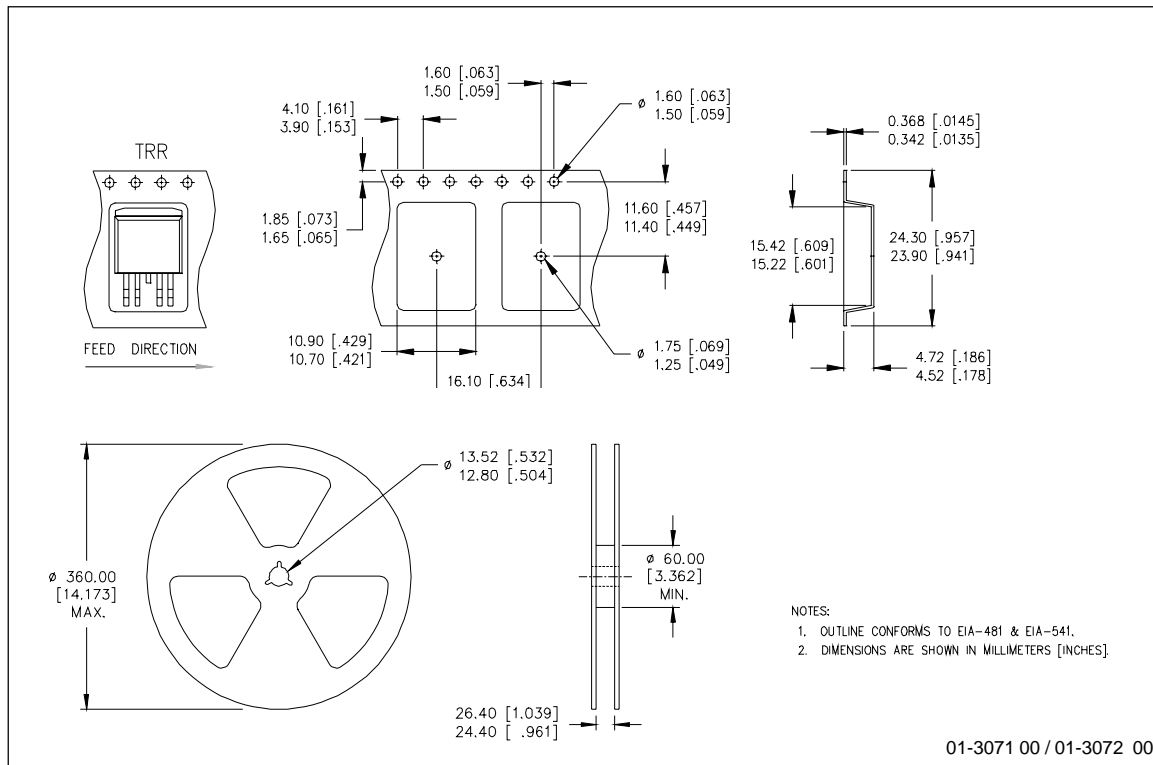

International
IR Rectifier

IR WORLD HEADQUARTERS: 233 Kansas St., El Segundo, California 90245 Tel: (310) 252-7105
IR EUROPEAN REGIONAL CENTRE: 439/445 Godstone Rd., Whyteleafe, Surrey CR3 0BL, United Kingdom
 Tel: ++ 44 (0) 20 8645 8000
IR JAPAN: K&H Bldg., 2F, 30-4 Nishi-Ikebukuro 3-Chome, Toshima-Ku, Tokyo, Japan 171-0021 Tel: 8133 983 0086
IR HONG KONG: Unit 308, #F, New East Ocean Centre, No. 9 Science Museum Road, Tsimshatsui East, Kowloon
 Hong Kong Tel: (852) 2803-7380

Data and specifications subject to change without notice. 3/27/2000