

# IRF120, IRF121, IRF122, IRF123

8.0A and 9.2A, 80V and 100V, 0.27 and 0.36 Ohm,  
 N-Channel, Power MOSFETs

October 1997

## Features

- 8.0A and 9.2A, 80V and 100V
- $r_{DS(ON)} = 0.27\Omega$  and  $0.36\Omega$
- SOA is Power Dissipation Limited
- Nanosecond Switching Speeds
- Linear Transfer Characteristics
- High Input Impedance
- Majority Carrier Device
- Related Literature
  - TB334 "Guidelines for Soldering Surface Mount Components to PC Boards"

## Ordering Information

PART NUMBER	PACKAGE	BRAND
IRF120	TO-204AA	IRF120
IRF121	TO-204AA	IRF121
IRF122	TO-204AA	IRF122
IRF123	TO-204AA	IRF123

NOTE: When ordering, use the entire part number.

## Description

These are N-Channel enhancement mode silicon gate power field effect transistors. They are advanced power MOSFETs designed, tested, and guaranteed to withstand a specified level of energy in the breakdown avalanche mode of operation. All of these power MOSFETs are designed for applications such as switching regulators, switching converters, motor drivers, relay drivers, and drivers for high power bipolar switching transistors requiring high speed and low gate drive power. These types can be operated directly from integrated circuits.

Formerly developmental type TA09594.

## Symbol

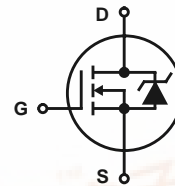

## Packaging

JEDEC TO-204AA

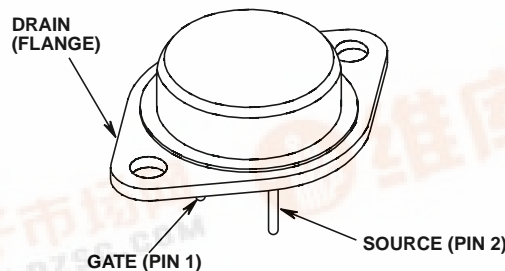

## IRF120, IRF121, IRF122, IRF123

### Absolute Maximum Ratings $T_C = 25^\circ\text{C}$ , Unless Otherwise Specified

	IRF120	IRF121	IRF122	IRF123	UNITS
Drain to Source Voltage (Note 1) . . . . . $V_{DS}$	100	80	100	80	V
Drain to Gate Voltage ( $R_{GS} = 20\text{k}\Omega$ ) (Note 1) . . . . . $V_{DGR}$	100	80	100	80	V
Continuous Drain Current . . . . . $I_D$	9.2	9.2	8.0	8.0	A
$T_C = 100^\circ\text{C}$ . . . . . $I_D$	6.5	6.5	5.6	5.6	A
Pulsed Drain Current (Note 3) . . . . . $I_{DM}$	37	37	32	32	A
Gate to Source Voltage . . . . . $V_{GS}$	$\pm 20$	$\pm 20$	$\pm 20$	$\pm 20$	V
Maximum Power Dissipation . . . . . $P_D$	60	60	60	60	W
Linear Derating Factor . . . . .	0.4	0.4	0.4	0.4	W/ $^\circ\text{C}$
Single Pulse Avalanche Energy Rating (Note 4) . . . . . $E_{AS}$	36	36	36	36	mJ
Operating and Storage Temperature . . . . . $T_J, T_{STG}$	-55 to 175	-55 to 175	-55 to 175	-55 to 175	$^\circ\text{C}$
Maximum Temperature for Soldering					
Leads at 0.063in (1.6mm) from Case for 10s . . . . . $T_L$	300	300	300	300	$^\circ\text{C}$
Package Body for 10s, See Techbrief 334 . . . . . $T_{pkg}$	260	260	260	260	$^\circ\text{C}$

CAUTION: Stresses above those listed in "Absolute Maximum Ratings" may cause permanent damage to the device. This is a stress only rating and operation of the device at these or any other conditions above those indicated in the operational sections of this specification is not implied.

**NOTE:**

- $T_J = 25^\circ\text{C}$  to  $150^\circ\text{C}$ .

### Electrical Specifications $T_C = 25^\circ\text{C}$ , Unless Otherwise Specified

PARAMETER	SYMBOL	TEST CONDITIONS	MIN	TYP	MAX	UNITS
Drain to Source Breakdown Voltage IRF120, IRF122	$BV_{DSS}$	$I_D = 250\mu\text{A}, V_{GS} = 0\text{V}$ (Figure 10)	100	-	-	V
			80	-	-	V
IRF121, IRF123						
Gate Threshold Voltage	$V_{GS(TH)}$	$V_{DS} = V_{GS}, I_D = 250\mu\text{A}$	2.0	-	4.0	V
Zero Gate Voltage Drain Current	$I_{DSS}$	$V_{DS} = \text{Rated } BV_{DSS}, V_{GS} = 0\text{V}$	-	-	25	$\mu\text{A}$
		$V_{DS} = 0.8 \times \text{Rated } BV_{DSS}, V_{GS} = 0\text{V}, T_J = 150^\circ\text{C}$	-	-	250	$\mu\text{A}$
On-State Drain Current (Note 2) IRF120, IRF121	$I_{D(ON)}$	$V_{DS} > I_{D(ON)} \times r_{DS(ON)MAX}, V_{GS} = 10\text{V}$	9.2	-	-	A
			8.0	-	-	A
IRF122, IRF123						
Gate to Source Leakage Current	$I_{GSS}$	$V_{GS} = \pm 20\text{V}$	-	-	$\pm 100$	nA
Drain to Source On Resistance (Note 2) IRF120, IRF121	$r_{DS(ON)}$	$I_D = 5.6\text{A}, V_{GS} = 10\text{V}$ (Figure 8, 9)	-	0.25	0.27	$\Omega$
				0.27	0.36	$\Omega$
IRF122, IRF123						
Forward Transconductance (Note 2)	$g_{fs}$	$V_{DS} > I_{D(ON)} \times r_{DS(ON)MAX}, I_D = 5.6\text{A}$ (Figure 12)	2.9	4.0	-	S
Turn-On Delay Time	$t_{d(ON)}$	$V_{DD} = 50\text{V}, I_D \approx 9.2\text{A}, R_{GS} = 18\Omega, R_L = 5.1\Omega$ (Figures 17, 18) MOSFET Switching Times are Essentially Independent of Operating Temperature	-	8.8	13	ns
Rise Time	$t_r$		-	30	45	ns
Turn-Off Delay Time	$t_{d(OFF)}$		-	19	29	ns
Fall Time	$t_f$		-	20	30	ns
Total Gate Charge (Gate to Source + Gate to Drain)	$Q_{g(TOT)}$	$V_{GS} = 10\text{V}, I_D = 5.6\text{A}, V_{DS} = 0.8 \times \text{Rated } BV_{DSS},$ $I_{g(REF)} = 1.5\text{mA}$ (Figures 14, 19, 20) Gate Charge is Essentially Independent of Operating Temperature	-	9.7	15	nC
Gate to Source Charge	$Q_{gs}$		-	2.2	-	nC
Gate to Drain "Miller" Charge	$Q_{gd}$		-	2.3	-	nC

## IRF120, IRF121, IRF122, IRF123

### Electrical Specifications $T_C = 25^\circ\text{C}$ , Unless Otherwise Specified (Continued)

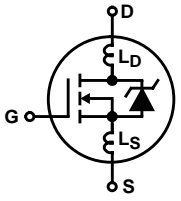
PARAMETER	SYMBOL	TEST CONDITIONS		MIN	TYP	MAX	UNITS
Input Capacitance	$C_{ISS}$	$V_{DS} = 25\text{V}$ , $V_{GS} = 0\text{V}$ , $f = 1\text{MHz}$ (Figure 11)		-	350	-	pF
Output Capacitance	$C_{OSS}$			-	130	-	pF
Reverse Transfer Capacitance	$C_{RSS}$			-	36	-	pF
Internal Drain Inductance	$L_D$	Measured Between the Contact Screw on the Flange that is Closer to Source and Gate Pins and the Center of Die	Modified MOSFET Symbol Showing the Internal Device Inductances 	-	5.0	-	nH
Internal Source Inductance	$L_S$	Measured From the Source Lead, 6mm (0.25in) From the Flange and the Source Bonding Pad		-	12.5	-	nH
Thermal Resistance, Junction to Case	$R_{\theta JC}$			-	-	2.5	$^\circ\text{C/W}$
Thermal Resistance, Junction to Ambient	$R_{\theta JA}$	Free Air Operation		-	-	30	$^\circ\text{C/W}$

### Source to Drain Diode Specifications

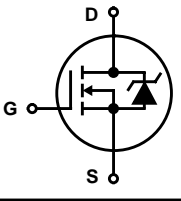
PARAMETER	SYMBOL	TEST CONDITIONS		MIN	TYP	MAX	UNITS
Continuous Source to Drain Current	$I_{SD}$	Modified MOSFET Symbol Showing the Integral Reverse P-N Junction Rectifier 	-	-	8.0	A	
Pulse Source to Drain Current (Note 3)	$I_{SDM}$		-	-	32	A	
Source to Drain Diode Voltage (Note 2)	$V_{SD}$	$T_J = 25^\circ\text{C}$ , $I_{SD} = 9.2\text{A}$ , $V_{GS} = 0\text{V}$ (Figure 13)		-	-	2.5	V
Reverse Recovery Time	$t_{rr}$	$T_J = 25^\circ\text{C}$ , $I_{SD} = 9.2\text{A}$ , $dI_{SD}/dt = 100\text{A}/\mu\text{s}$		55	110	240	ns
Reverse Recovery Charge	$Q_{RR}$	$T_J = 25^\circ\text{C}$ , $I_{SD} = 9.2\text{A}$ , $dI_{SD}/dt = 100\text{A}/\mu\text{s}$		0.25	0.53	1.10	$\mu\text{C}$

#### NOTES:

2. Pulse test: pulse width  $\leq 300\mu\text{s}$ , duty cycle  $\leq 2\%$ .
3. Repetitive rating: pulse width limited by maximum junction temperature. See Transient Thermal Impedance curve (Figure 3).
4.  $V_{DD} = 25\text{V}$ , starting  $T_J = 25^\circ\text{C}$ ,  $L = 640\mu\text{H}$ ,  $R_G = 25\Omega$ , peak  $I_{AS} = 9.2\text{A}$  (Figures 15, 16).

# IRF120, IRF121, IRF122, IRF123

## Typical Performance Curves Unless Otherwise Specified

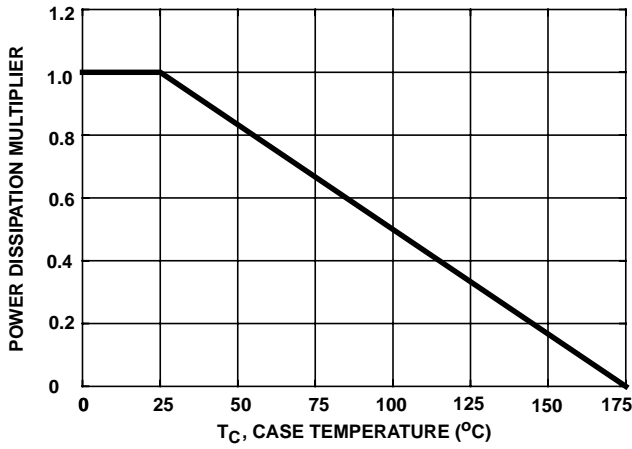

FIGURE 1. NORMALIZED POWER DISSIPATION vs CASE TEMPERATURE

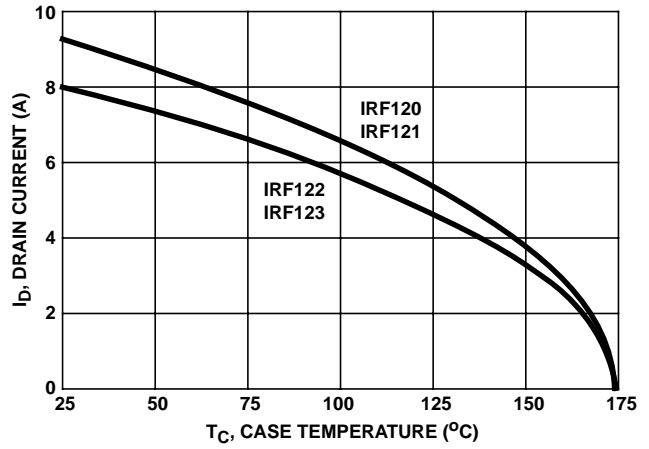

FIGURE 2. MAXIMUM CONTINUOUS DRAIN CURRENT vs CASE TEMPERATURE

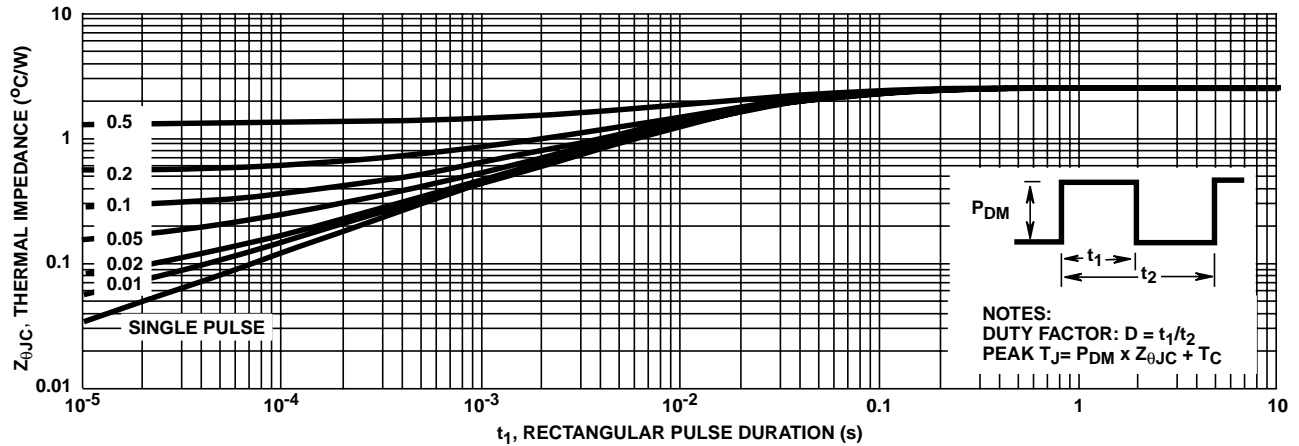

FIGURE 3. MAXIMUM TRANSIENT THERMAL IMPEDANCE

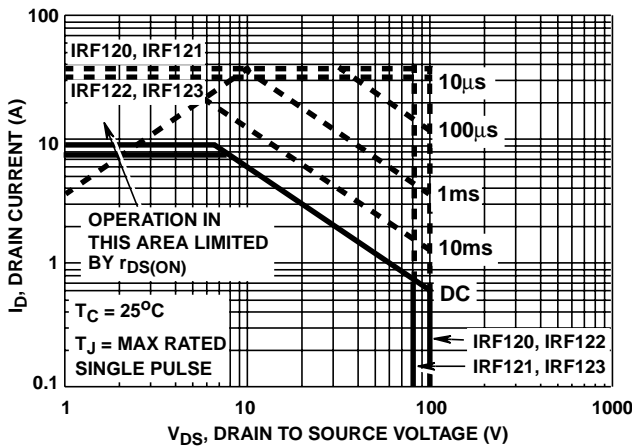

FIGURE 4. FORWARD BIAS SAFE OPERATING AREA

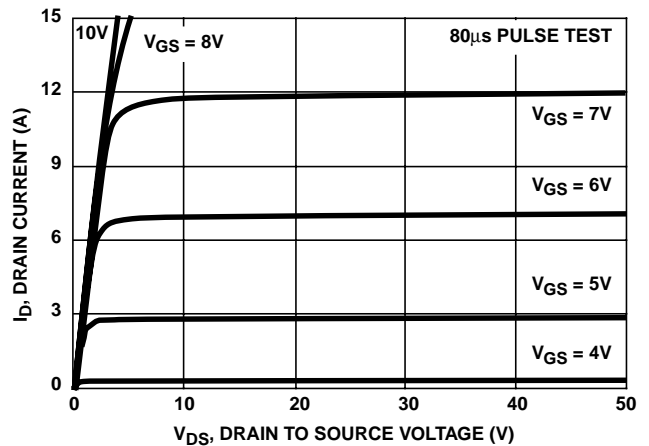

FIGURE 5. OUTPUT CHARACTERISTICS

# IRF120, IRF121, IRF122, IRF123

## Typical Performance Curves Unless Otherwise Specified (Continued)

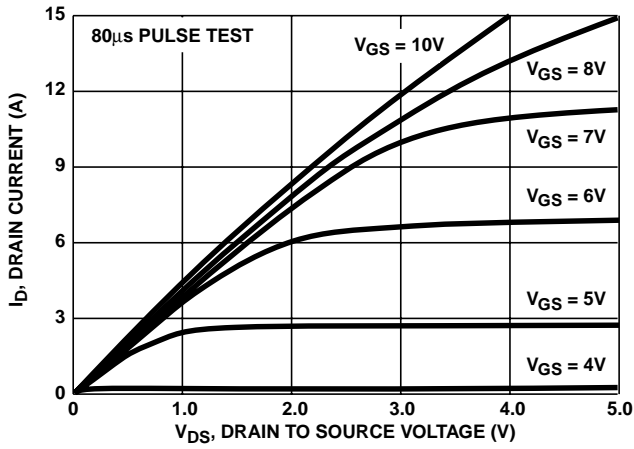

FIGURE 6. SATURATION CHARACTERISTICS

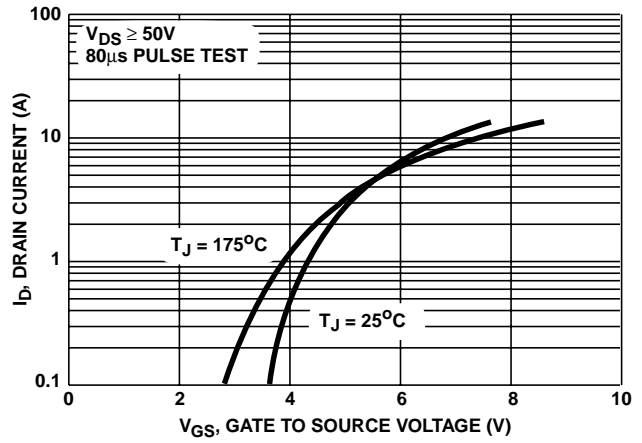

FIGURE 7. TRANSFER CHARACTERISTICS

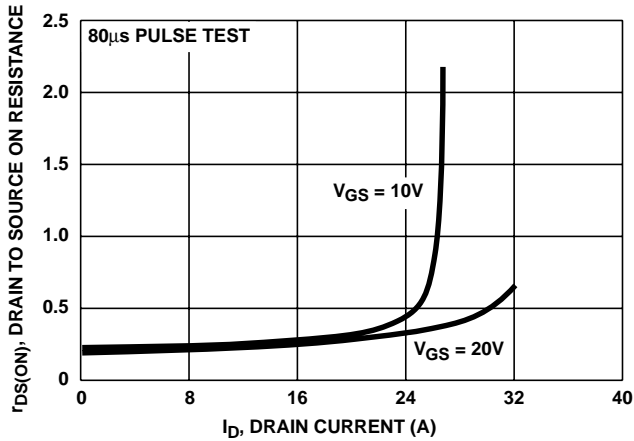

FIGURE 8. DRAIN TO SOURCE ON RESISTANCE vs GATE VOLTAGE AND DRAIN CURRENT

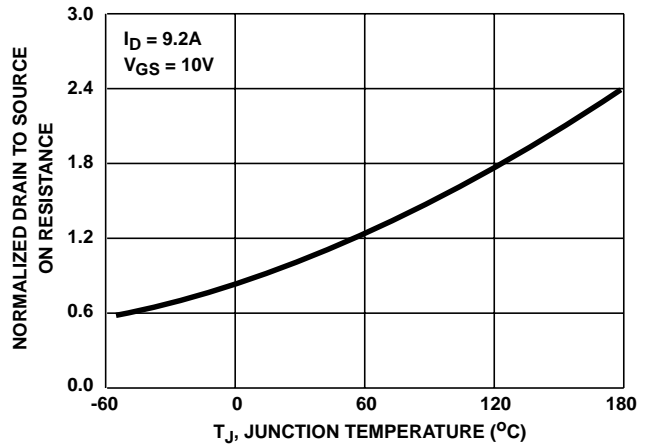

FIGURE 9. NORMALIZED DRAIN TO SOURCE ON RESISTANCE vs JUNCTION TEMPERATURE

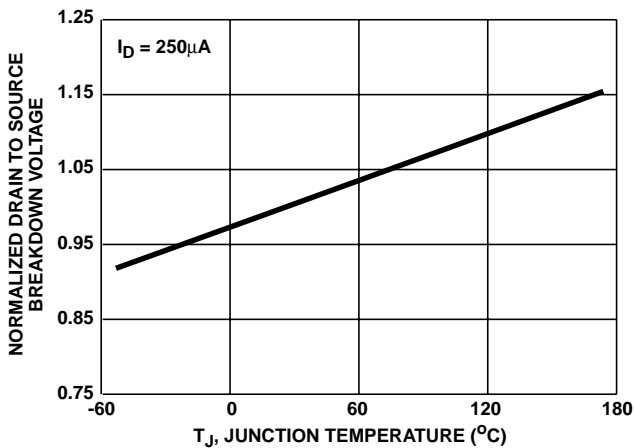

FIGURE 10. NORMALIZED DRAIN TO SOURCE BREAKDOWN VOLTAGE vs JUNCTION TEMPERATURE

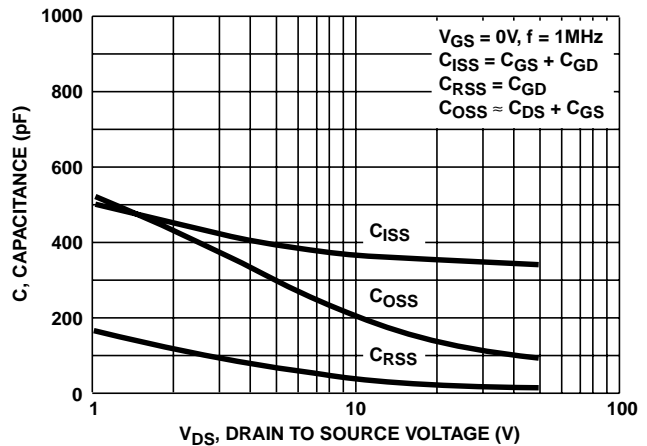

FIGURE 11. CAPACITANCE vs DRAIN TO SOURCE VOLTAGE

# IRF120, IRF121, IRF122, IRF123

## Typical Performance Curves Unless Otherwise Specified (Continued)

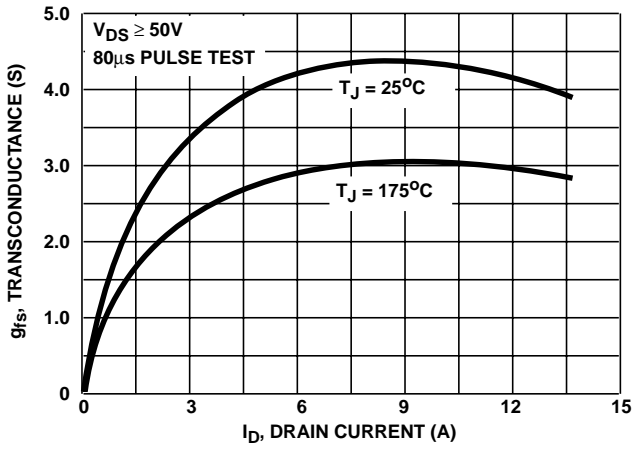

FIGURE 12. TRANSCONDUCTANCE vs DRAIN CURRENT

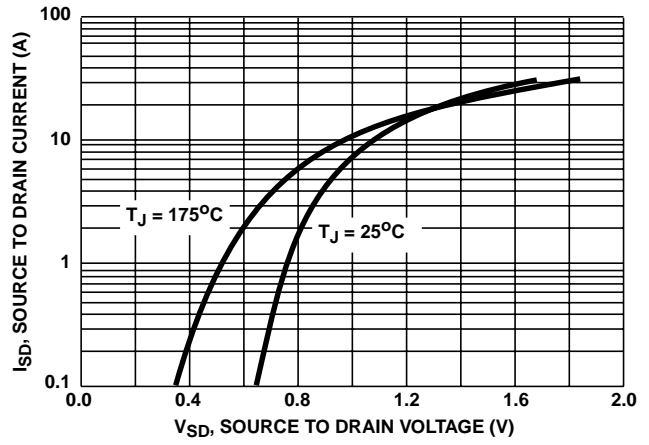

FIGURE 13. SOURCE TO DRAIN DIODE VOLTAGE

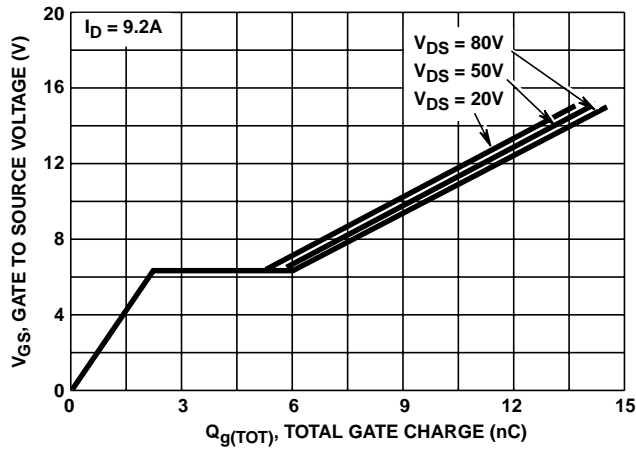

FIGURE 14. GATE TO SOURCE VOLTAGE vs GATE CHARGE

## Test Circuits and Waveforms

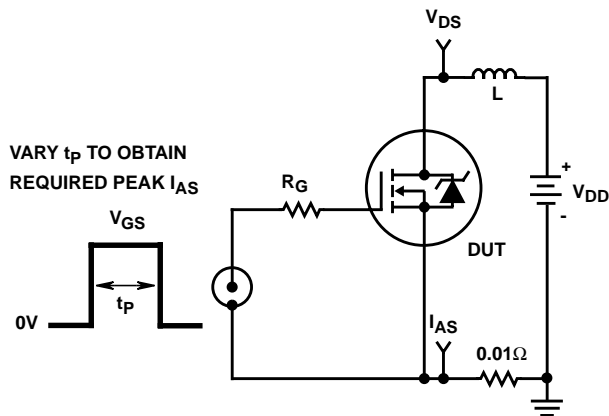

FIGURE 15. UNCLAMPED ENERGY TEST CIRCUIT

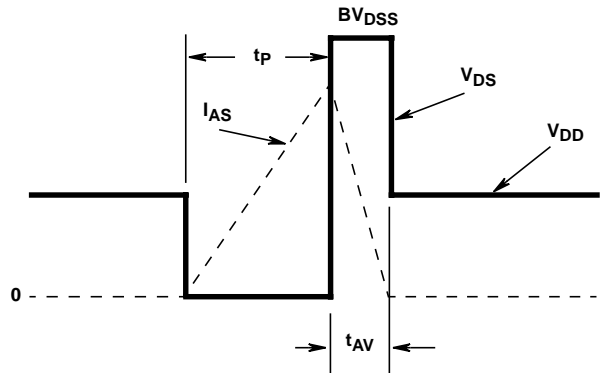

FIGURE 16. UNCLAMPED ENERGY WAVEFORMS

# IRF120, IRF121, IRF122, IRF123

## Test Circuits and Waveforms (Continued)

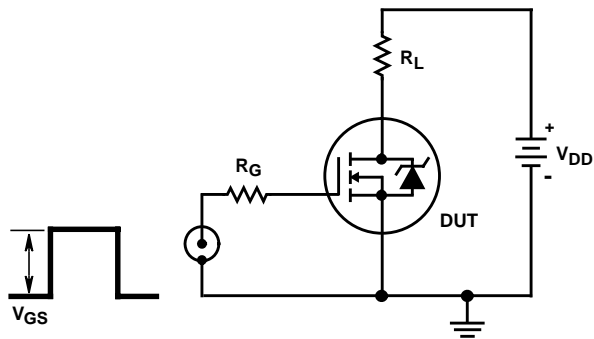

FIGURE 17. SWITCHING TIME TEST CIRCUIT

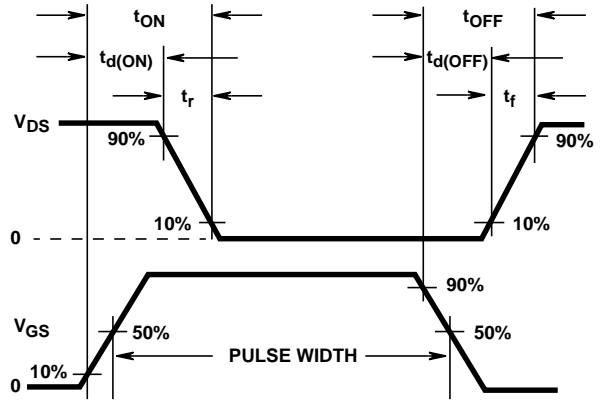

FIGURE 18. RESISTIVE SWITCHING WAVEFORMS

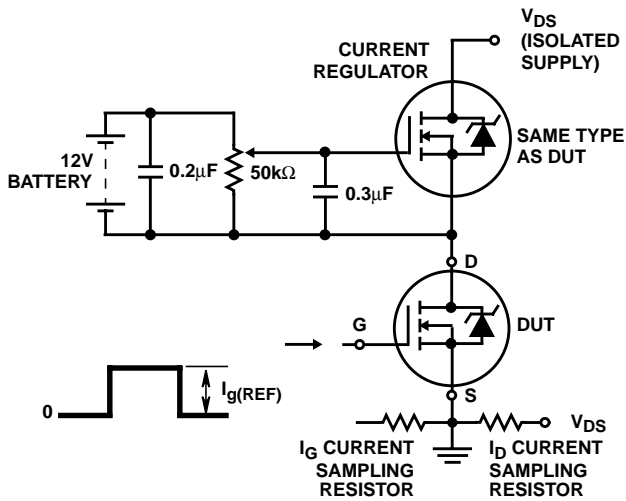

FIGURE 19. GATE CHARGE TEST CIRCUIT

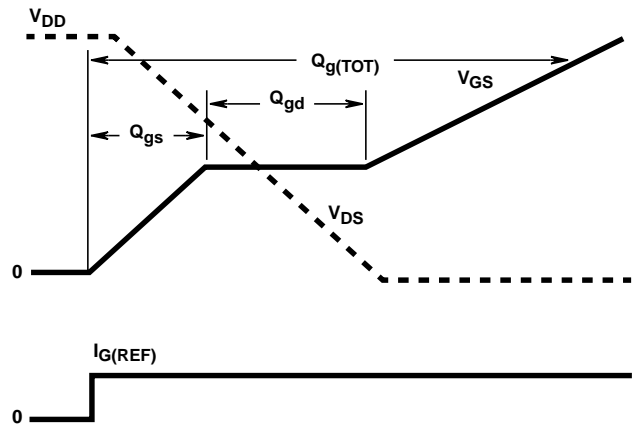

FIGURE 20. GATE CHARGE WAVEFORMS