

98 DE 7964142 0005079 9

**N-CHANNEL
POWER MOSFETS**

IRF140/141/142/143

FEATURES

- Low $R_{DS(on)}$
- Improved inductive ruggedness
- Fast switching times
- Rugged polysilicon gate cell structure
- Low input capacitance
- Extended safe operating area
- Improved high temperature reliability
- TO-3 package (High current)

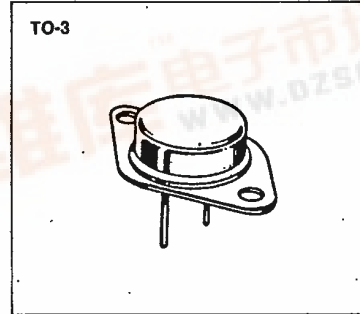

PRODUCT SUMMARY

Part Number	V _{DS}	R _{DS(on)}	I _D
IRF140	100V	0.085Ω	27A
IRF141	60V	0.085Ω	27A
IRF142	100V	0.11Ω	24A
IRF143	60V	0.11Ω	24A

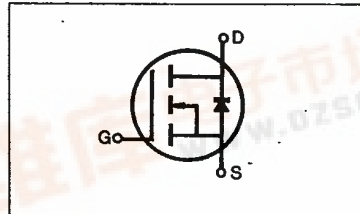

MAXIMUM RATINGS

Characteristic	Symbol	IRF140	IRF141	IRF142	IRF143	Unit
Drain-Source Voltage (1)	V _{DSS}	100	60	100	60	V _{dc}
Drain-Gate Voltage (R _{GS} =1.0MΩ) (1)	V _{DGR}	100	60	100	60	V _{dc}
Gate-Source Voltage	V _{GS}	±20				V _{dc}
Continuous Drain Current T _C =25°C	I _D	27	27	24	24	A _{dc}
Continuous Drain Current T _C =100°C	I _D	17	17	15	15	A _{dc}
Drain Current—Pulsed (3)	I _{DM}	108	108	96	96	A _{dc}
Gate Current—Pulsed	I _{GM}	±1.5				A _{dc}
Total Power Dissipation @ T _C =25°C Derate above 25°C	P _D	125 1.0				Watts W/°C
Operating and Storage Junction Temperature Range	T _J , T _{stg}	-55 to 150				°C
Maximum Lead Temp. for Soldering Purposes, 1/8" from case for 5 seconds	T _L	300				°C

Notes: (1) T_J=25°C to 150°C
 (2) Pulse test: Pulse width≤300μs, Duty Cycle≤2%
 (3) Repetitive rating: Pulse width limited by max. junction temperature



IRF140/141/142/143**N-CHANNEL
POWER MOSFETS****ELECTRICAL CHARACTERISTICS** ($T_C=25^\circ\text{C}$ unless otherwise specified)

Characteristic	Symbol	Type	Min	Typ	Max	Units	Test Conditions
Drain-Source Breakdown Voltage	BV_{DSS}	IRF140 IRF142	100	—	—	V	$V_{GS}=0V$
		IRF141 IRF143	60	—	—	V	$I_D=250\mu A$
Gate Threshold Voltage	$V_{GS(th)}$	ALL	2.0	—	4.0	V	$V_{DS}=V_{GS}$, $I_D=250\mu A$
Gate-Source Leakage Forward	I_{GSS}	ALL	—	—	100	nA	$V_{GS}=20V$
Gate-Source Leakage Reverse	I_{GSS}	ALL	—	—	-100	nA	$V_{GS}=-20V$
Zero Gate Voltage Drain Current	I_{DSS}	ALL	—	—	250	μA	$V_{DS}=\text{Max. Rating}$, $V_{GS}=0V$
			—	—	1000	μA	$V_{DS}=\text{Max. Rating}\times 0.8$, $V_{GS}=0V$, $T_C=125^\circ\text{C}$
On-State Drain-Source Current (2)	$I_{D(on)}$	IRF140 IRF141	27	—	—	A	$V_{DS}>I_{D(on)}\times R_{DS(on) \text{ max.}}$, $V_{GS}=10V$
		IRF142 IRF143	24	—	—	A	
Static Drain-Source On-State Resistance (2)	$R_{DS(on)}$	IRF140 IRF141	—	0.06	0.085	Ω	$V_{GS}=10V$, $I_D=15A$
		IRF142 IRF143	—	0.09	0.11	Ω	
Forward Transconductance (2)	g_{fs}	ALL	6.0	10.5	—	S	$V_{DS}>I_{D(on)}\times R_{DS(on) \text{ max.}}$, $I_D=15A$
Input Capacitance	C_{iss}	ALL	—	1320	1600	pF	$V_{GS}=0V$, $V_{DS}=25V$, $f=1.0\text{MHz}$
Output Capacitance	C_{oss}	ALL	—	600	800	pF	
Reverse Transfer Capacitance	C_{rss}	ALL	—	250	300	pF	
Turn-On Delay Time	$t_{d(on)}$	ALL	—	—	30	ns	$V_{DD}=0.5BV_{DSS}$, $I_D=15A$, $Z_O=4.7\Omega$ (MOSFET switching times are essentially independent of operating temperature.)
Rise Time	t_r	ALL	—	—	60	ns	
Turn-Off Delay Time	$t_{d(off)}$	ALL	—	—	80	ns	
Fall Time	t_f	ALL	—	—	30	ns	
Total Gate Charge (Gate-Source Plus Gate-Drain)	Q_g	ALL	—	39	60	nC	$V_{GS}=10V$, $I_D=34A$, $V_{DS}=0.8 \text{ Max. Rating}$ (Gate charge is essentially independent of operating temperature.)
Gate-Source Charge	Q_{gs}	ALL	—	12	—	nC	
Gate-Drain ("Miller") Charge	Q_{gd}	ALL	—	27	—	nC	

THERMAL RESISTANCE

Junction-to-Case	R_{thJC}	ALL	—	—	1.0	K/W	
Case-to-Sink	R_{thCS}	ALL	—	0.1	—	K/W	Mounting surface flat, smooth, and greased
Junction-to-Ambient	R_{thJA}	ALL	—	—	30	K/W	Free Air Operation

- Notes: (1) $T_J=25^\circ\text{C}$ to 150°C
(2) Pulse test: Pulse width $\leq 300\mu\text{s}$, Duty Cycle $\leq 2\%$
(3) Repetitive rating: Pulse width limited by max. junction temperature

IRF140/141/142/143

N-CHANNEL POWER MOSFETS

SOURCE-DRAIN DIODE RATINGS AND CHARACTERISTICS

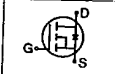
Characteristic	Symbol	Type	Min	Typ	Max	Units	Test Conditions
Continuous Source Current (Body Diode)	I_S	IRF140	—	—	27	A	Modified MOSFET symbol showing the integral reverse P-N junction rectifier 
		IRF141	—	—	27	A	
		IRF142	—	—	24	A	
		IRF143	—	—	24	A	
Pulse Source Current (Body Diode) (3)	I_{SM}	IRF140	—	—	108	A	
		IRF141	—	—	108	A	
		IRF142	—	—	96	A	
		IRF143	—	—	96	A	
Diode Forward Voltage (2)	V_{SD}	IRF140	—	—	2.5	V	$T_C=25^\circ\text{C}$, $I_S=27\text{A}$, $V_{GS}=0\text{V}$
		IRF141	—	—	2.5	V	
		IRF142	—	—	2.3	V	
Reverse Recovery Time	t_{rr}	ALL	—	500	—	ns	$T_J=150^\circ\text{C}$, $I_F=27\text{A}$, $di_F/dt=100\text{A}/\mu\text{s}$

Notes: (1) $T_J=25^\circ\text{C}$ to 150°C (2) Pulse test: Pulse width $\leq 300\mu\text{s}$, Duty Cycle $\leq 2\%$
 (3) Repetitive rating: Pulse width limited by max. junction temperature

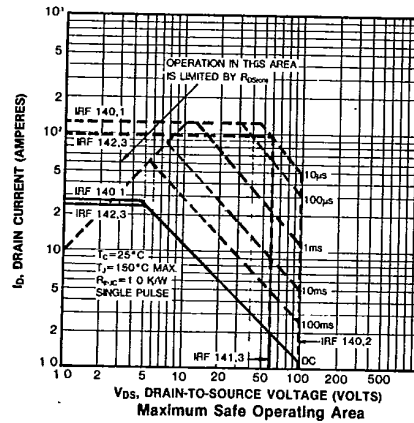
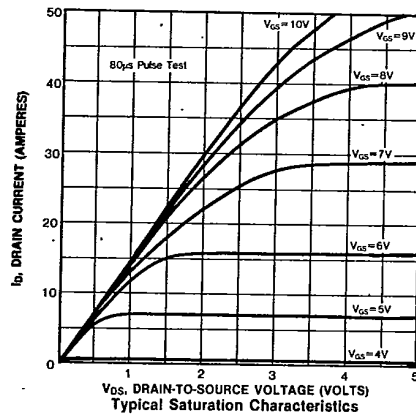
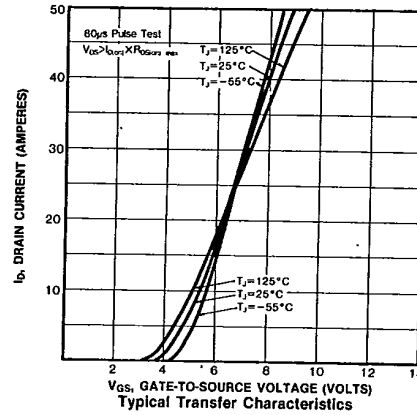
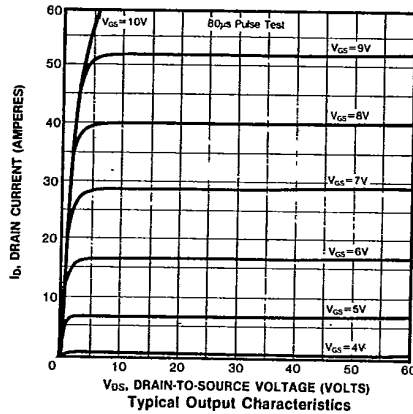

IRF140/141/142/143

N-CHANNEL
POWER MOSFETS

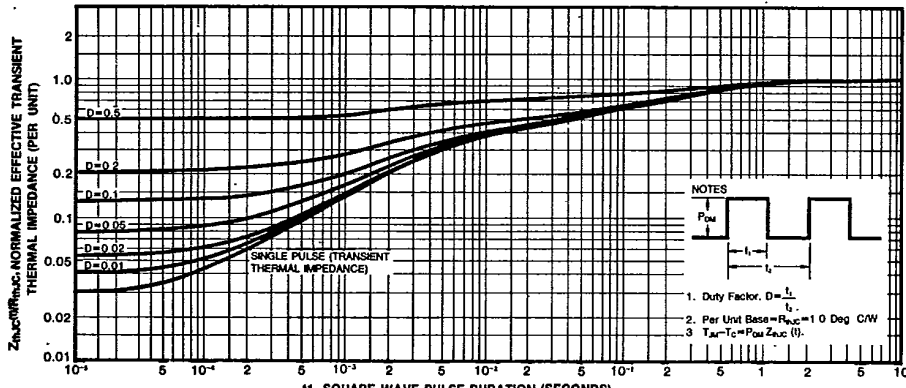

11. SQUARE WAVE PULSE DURATION (SECONDS)
Maximum Effective Transient Thermal Impedance Junction-to-Case Vs. Pulse Duration

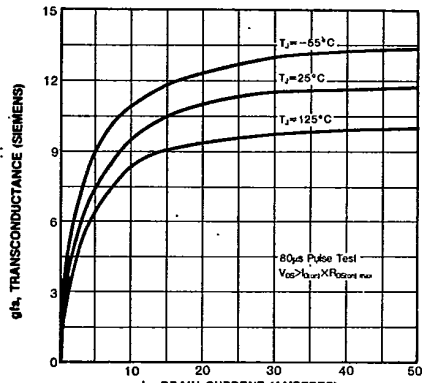

Typical Transconductance Vs. Drain Current

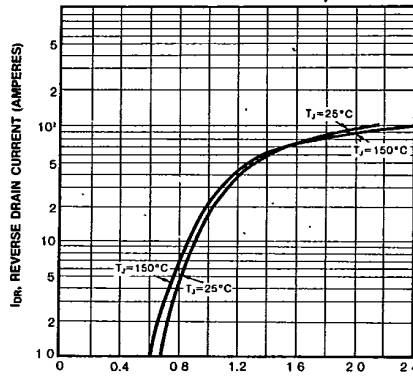

Typical Source-Drain Diode Forward Voltage

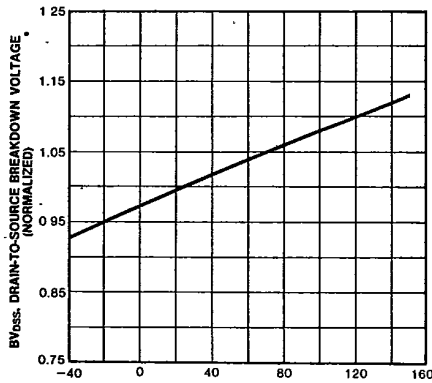

Breakdown Voltage Vs. Temperature

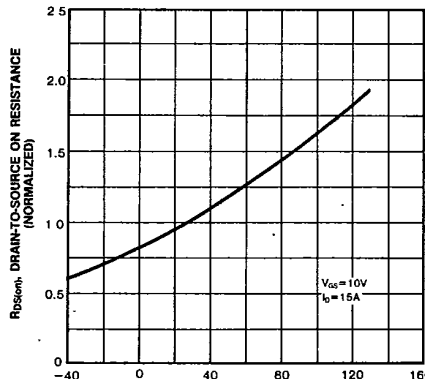

Normalized On-Resistance Vs. Temperature

IRF140/141/142/143

**N-CHANNEL
POWER MOSFETS**

