

International IR Rectifier

PD -94116

IRG4BC20MD-S

INSULATED GATE BIPOLAR TRANSISTOR WITH
ULTRAFAST SOFT RECOVERY DIODE

Short Circuit Rated
Fast IGBT

Features

- Rugged: 10μsec short circuit capable at $V_{GS}=15V$
- Low $V_{CE(on)}$ for 4 to 10kHz applications
- IGBT Co-packaged with ultra-soft-recovery antiparallel diode
- Industry standard D²Pak package

Benefits

- Offers highest efficiency and short circuit capability for intermediate applications
- Provides best efficiency for the mid range frequency (4 to 10kHz)
- Optimized for Appliance Motor Drives, Industrial (Short Circuit Proof) Drives and Intermediate Frequency Range Drives
- High noise immune "Positive Only" gate drive- Negative bias gate drive not necessary
- For Low EMI designs- requires little or no snubbing
- Single Package switch for bridge circuit applications
- Compatible with high voltage Gate Driver IC's
- Allows simpler gate drive

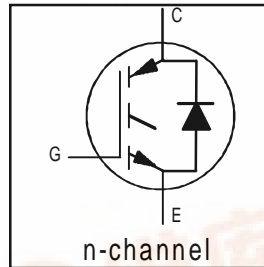

$V_{CES} = 600V$
$V_{CE(on)} \text{ typ.} = 1.85V$
@ $V_{GE} = 15V, I_C = 11A$



Absolute Maximum Ratings

	Parameter	Max.	Units
V_{CES}	Collector-to-Emitter Voltage	600	V
$I_C @ T_C = 25^\circ C$	Continuous Collector Current	18	A
$I_C @ T_C = 100^\circ C$	Continuous Collector Current	11	
I_{CM}	Pulsed Collector Current ①	36	
I_{LM}	Clamped Inductive Load Current ②	36	
$I_F @ T_C = 100^\circ C$	Diode Continuous Forward Current	7.0	A
t_{sc}	Short Circuit Withstand Time	10	
I_{FM}	Diode Maximum Forward Current	36	A
V_{GE}	Gate-to-Emitter Voltage	± 20	V
$P_D @ T_C = 25^\circ C$	Maximum Power Dissipation	60	W
$P_D @ T_C = 100^\circ C$	Maximum Power Dissipation	24	
T_J	Operating Junction and	-55 to +150	°C
T_{STG}	Storage Temperature Range		
	Soldering Temperature, for 10 sec.	300 (0.063 in. (1.6mm) from case)	
	Mounting Torque, 6-32 or M3 Screw.	10 lbf•in (1.1 N•m)	

Thermal Resistance

	Parameter	Min.	Typ.	Max.	Units
$R_{\theta JC}$	Junction-to-Case - IGBT	-----	-----	2.1	°C/W
$R_{\theta JC}$	Junction-to-Case - Diode	-----	-----	2.5	
$R_{\theta CS}$	Case-to-Sink, flat, greased surface	-----	0.50	-----	
$R_{\theta JA}$	Junction-to-Ambient, typical socket mount	-----	-----	80	
Wt	Weight	-----	2 (0.07)	-----	g (oz)



IRG4BC20MD-S

International
IRF Rectifier

Electrical Characteristics @ T_J = 25°C (unless otherwise specified)

	Parameter	Min.	Typ.	Max.	Units	Conditions
V _{(BR)CES}	Collector-to-Emitter Breakdown Voltage ^③	600	----	----	V	V _{GE} = 0V, I _C = 250μA
ΔV _{(BR)CES/ΔT_J}	Temperature Coeff. of Breakdown Voltage	----	0.67	----	V/°C	V _{GE} = 0V, I _C = 1.0mA
V _{CE(on)}	Collector-to-Emitter Saturation Voltage	----	1.85	2.1	V	I _C = 11A V _{GE} = 15V
		----	2.46	----		I _C = 18A See Fig. 2, 5
		----	2.07	----		I _C = 11A, T _J = 150°C
V _{GE(th)}	Gate Threshold Voltage	4.0	----	6.5		V _{CE} = V _{GE} , I _C = 250μA
ΔV _{GE(th)/ΔT_J}	Temperature Coeff. of Threshold Voltage	----	-11	----	mV/°C	V _{CE} = V _{GE} , I _C = 250μA
g _{fe}	Forward Transconductance ^④	3.0	3.6	----	S	V _{CE} = 100V, I _C = 11A
I _{CES}	Zero Gate Voltage Collector Current	----	----	250	μA	V _{GE} = 0V, V _{CE} = 600V
		----	----	2500		V _{GE} = 0V, V _{CE} = 600V, T _J = 150°C
V _{FM}	Diode Forward Voltage Drop	----	1.4	1.7	V	I _C = 8.0A See Fig. 13
		----	1.3	1.6		I _C = 8.0A, T _J = 150°C
I _{GES}	Gate-to-Emitter Leakage Current	----	----	±100	nA	V _{GE} = ±20V

Switching Characteristics @ T_J = 25°C (unless otherwise specified)

	Parameter	Min.	Typ.	Max.	Units	Conditions
Q _g	Total Gate Charge (turn-on)	----	39	59	nC	I _C = 11A V _{CC} = 400V See Fig. 8 V _{GE} = 15V
Q _{ge}	Gate - Emitter Charge (turn-on)	----	5.3	8.0		
Q _{gc}	Gate - Collector Charge (turn-on)	----	20	30		
t _{d(on)}	Turn-On Delay Time	----	21	----	ns	T _J = 25°C I _C = 11A, V _{CC} = 480V V _{GE} = 15V, R _G = 50Ω Energy losses include "tail" and diode reverse recovery.
t _r	Rise Time	----	37	----		
t _{d(off)}	Turn-Off Delay Time	----	463	690		
t _f	Fall Time	----	340	510	mJ	See Fig. 9, 10, 11, 18
E _{on}	Turn-On Switching Loss	----	0.41	----		
E _{off}	Turn-Off Switching Loss	----	2.03	----		
E _{ts}	Total Switching Loss	----	2.44	3.7	ns	T _J = 150°C, See Fig. 9, 10, 11, 18 I _C = 6.5A, V _{CC} = 480V V _{GE} = 15V, R _G = 50Ω Energy losses include "tail" and diode reverse recovery.
t _{d(on)}	Turn-On Delay Time	----	19	----		
t _r	Rise Time	----	41	----		
t _{d(off)}	Turn-Off Delay Time	----	590	----	mJ	See Fig. 9, 10, 11, 18
t _f	Fall Time	----	600	----		
E _{ts}	Total Switching Loss	----	3.49	----		
L _E	Internal Emitter Inductance	----	7.5	----	nH	Measured 5mm from package
C _{ies}	Input Capacitance	----	460	----	pF	V _{GE} = 0V V _{CC} = 30V See Fig. 7 f = 1.0MHz
C _{oes}	Output Capacitance	----	54	----		
C _{res}	Reverse Transfer Capacitance	----	14	----		
t _{rr}	Diode Reverse Recovery Time	----	37	55	ns	T _J = 25°C See Fig. 14
		----	55	90		T _J = 125°C
I _{rr}	Diode Peak Reverse Recovery Current	----	3.5	5.0	A	T _J = 25°C See Fig. 15
		----	4.5	8.0		T _J = 125°C
Q _{rr}	Diode Reverse Recovery Charge	----	65	138	nC	T _J = 25°C See Fig. 16
		----	124	360		T _J = 125°C
di _{(rec)M/dt}	Diode Peak Rate of Fall of Recovery During t _b	----	240	----	A/μs	T _J = 25°C See Fig. 17
		----	210	----		T _J = 125°C

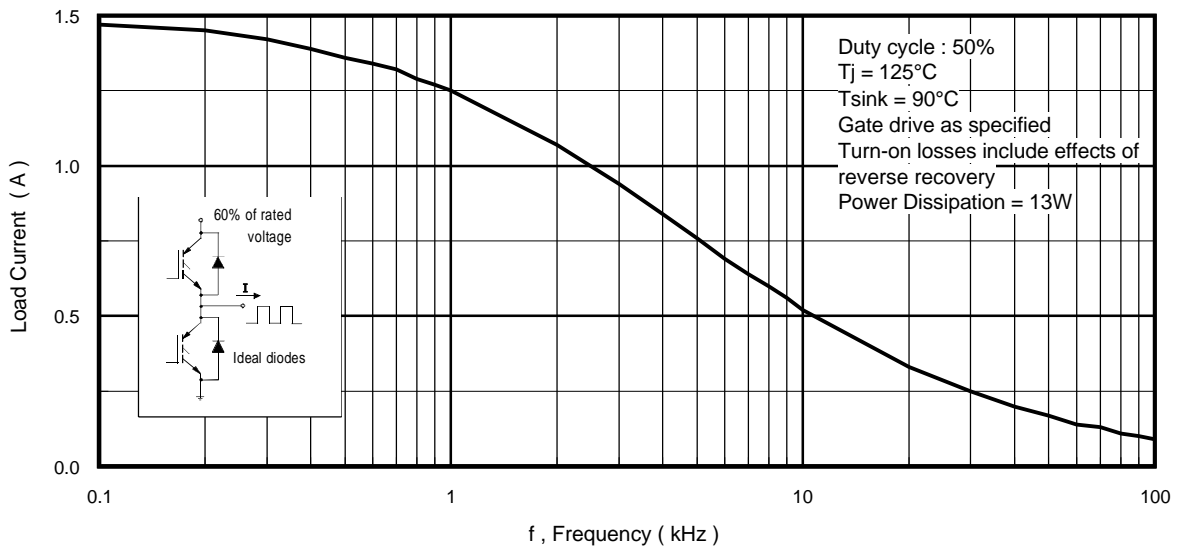

Fig. 1 - Typical Load Current vs. Frequency
 (Load Current = I_{RMS} of fundamental)

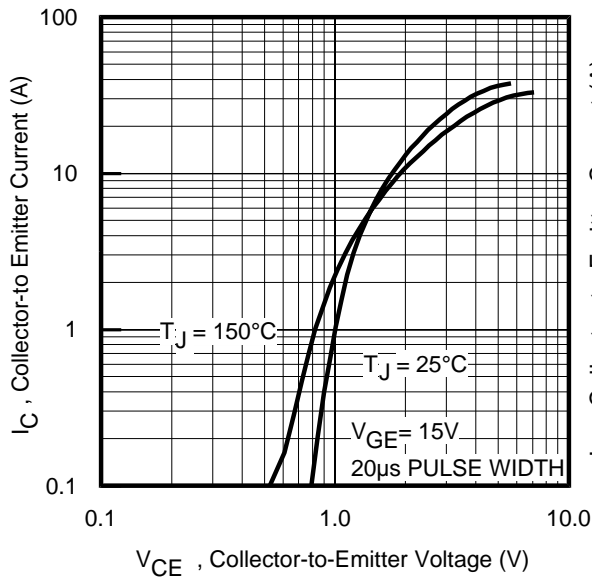

Fig. 2 - Typical Output Characteristics

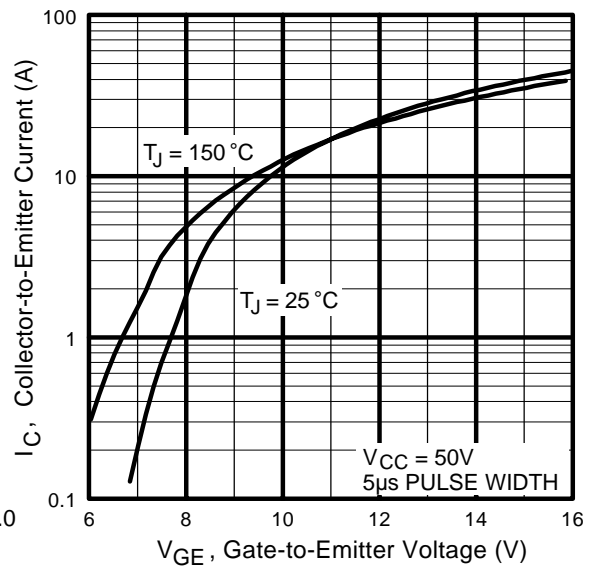

Fig. 3 - Typical Transfer Characteristics

IRG4BC20MD-S

International
IRF Rectifier

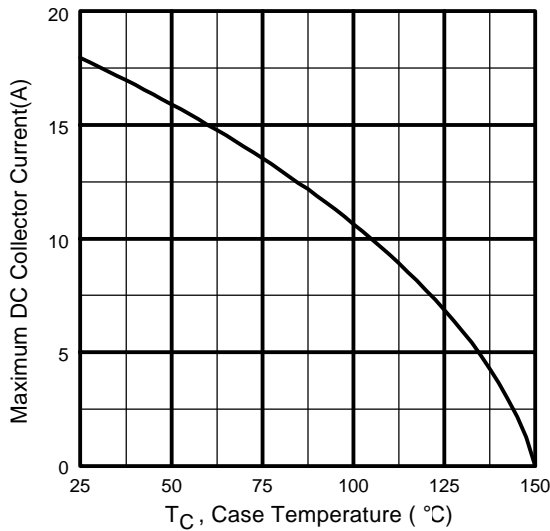

Fig. 4 - Maximum Collector Current vs. Case Temperature

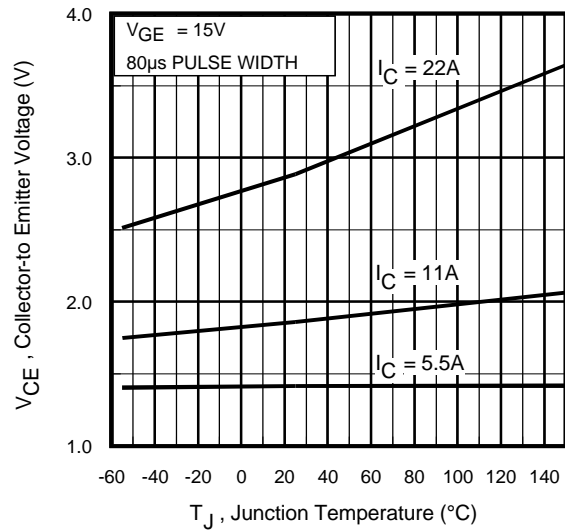

Fig. 5 - Typical Collector-to-Emitter Voltage vs. Junction Temperature

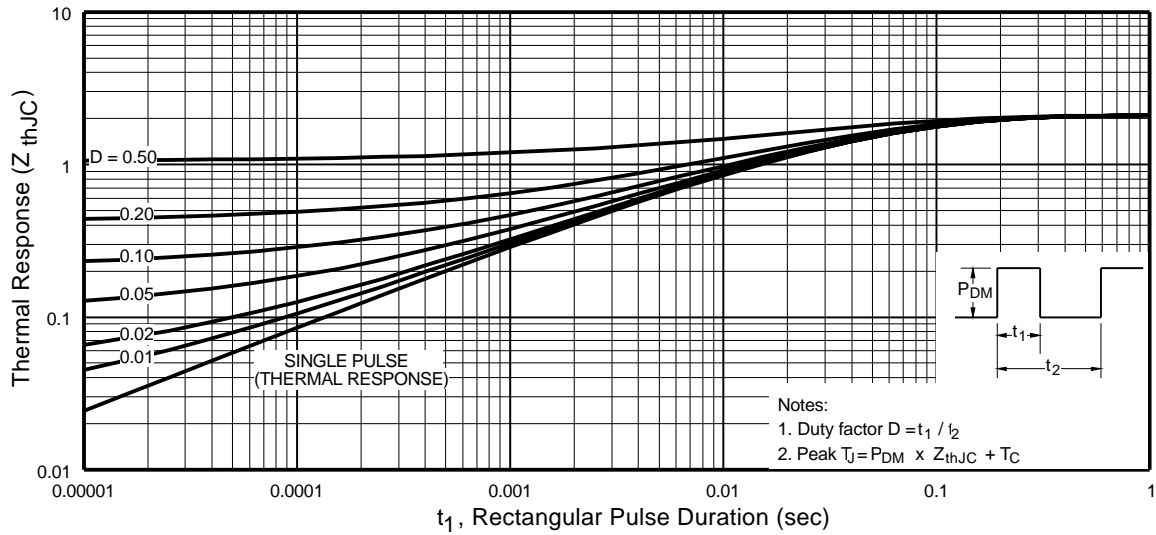

Fig. 6 - Maximum IGBT Effective Transient Thermal Impedance, Junction-to-Case

IRG4BC20MD-S

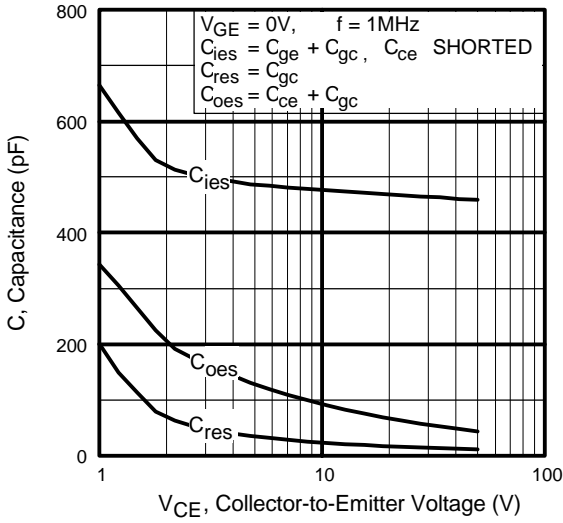

Fig. 7 - Typical Capacitance vs. Collector-to-Emitter Voltage

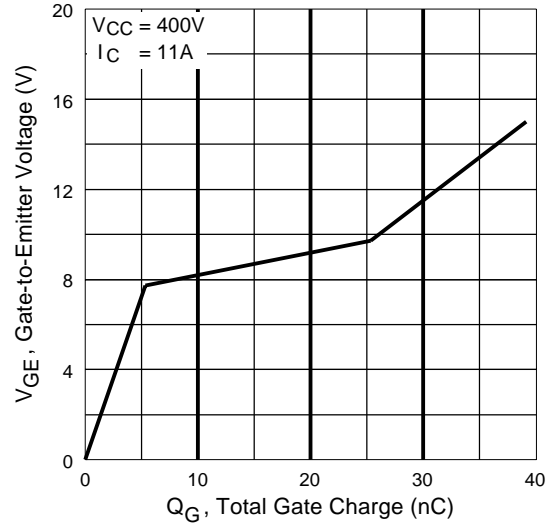

Fig. 8 - Typical Gate Charge vs. Gate-to-Emitter Voltage

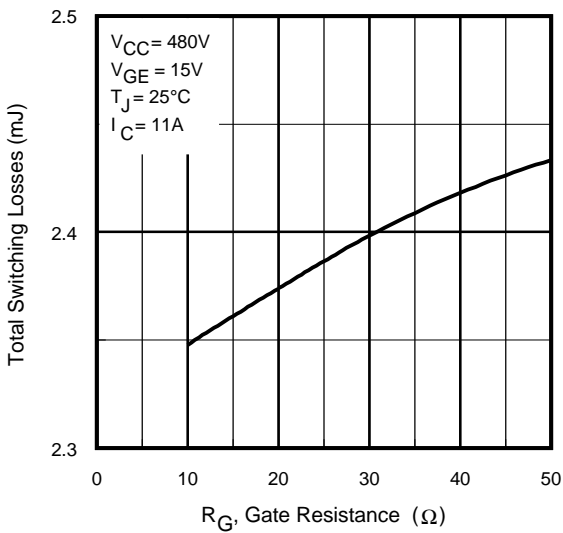

Fig. 9 - Typical Switching Losses vs. Gate Resistance

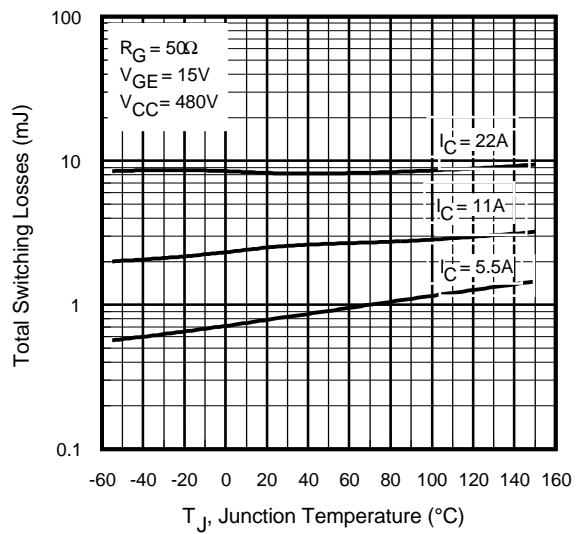

Fig. 10 - Typical Switching Losses vs. Junction Temperature

IRG4BC20MD-S

International
IR Rectifier

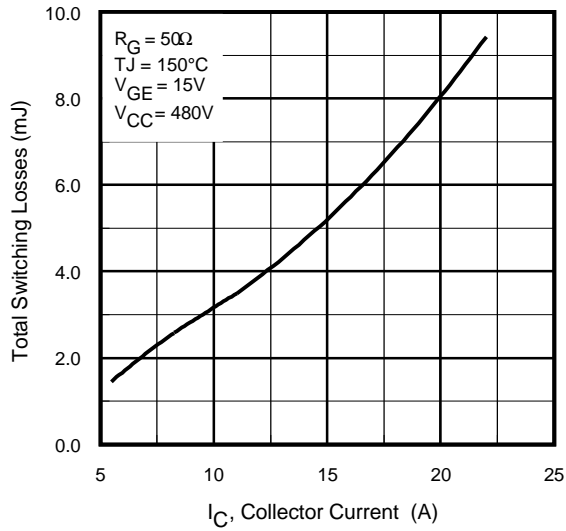

Fig. 11 - Typical Switching Losses vs. Collector-to-Emitter Current

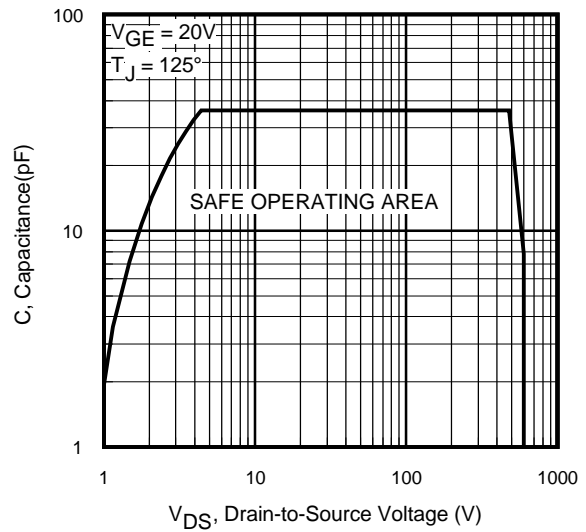

Fig. 12 - Turn-Off SOA

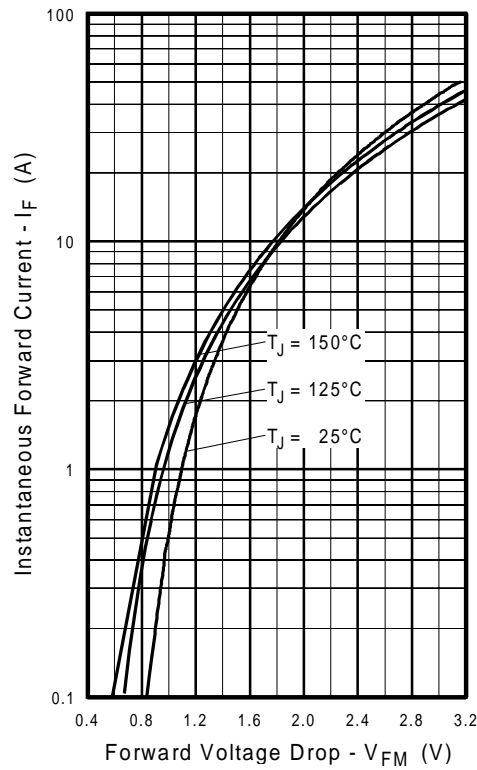

Fig. 13 - Maximum Forward Voltage Drop vs. Instantaneous Forward Current

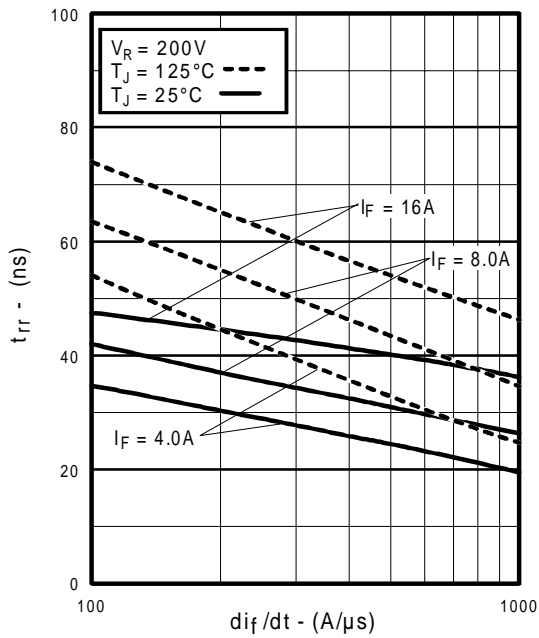

Fig. 14 - Typical Reverse Recovery vs. di_f/dt

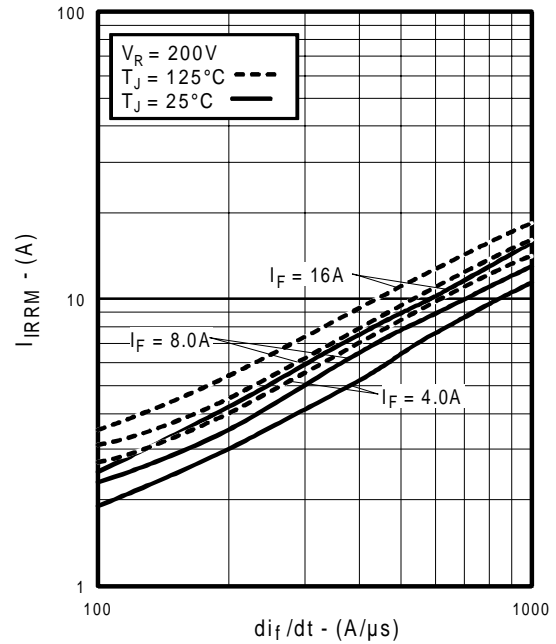

Fig. 15 - Typical Recovery Current vs. di_f/dt

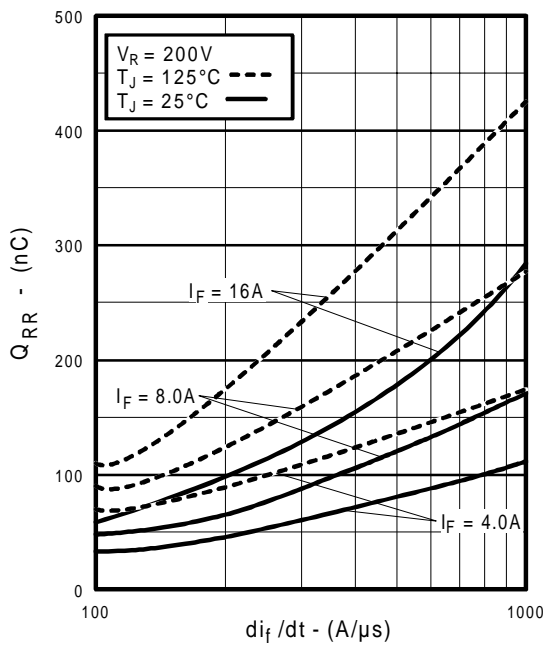

Fig. 16 - Typical Stored Charge vs. di_f/dt

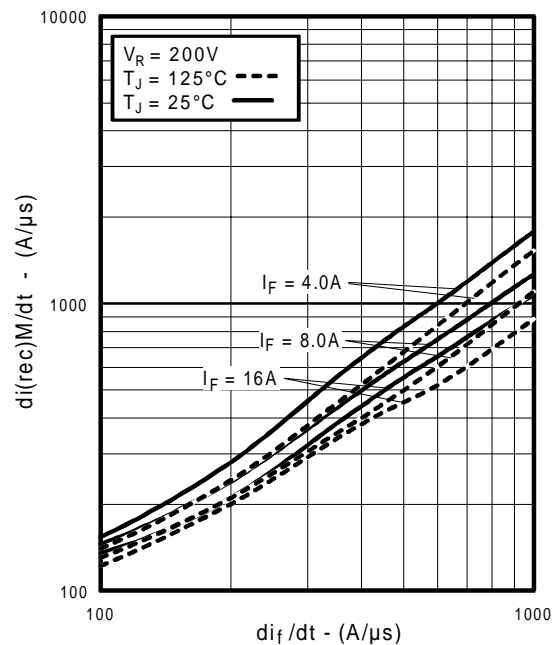

Fig. 17 - Typical $di_{(rec)M}/dt$ vs. di_f/dt

IRG4BC20MD-S

International
IRF Rectifier

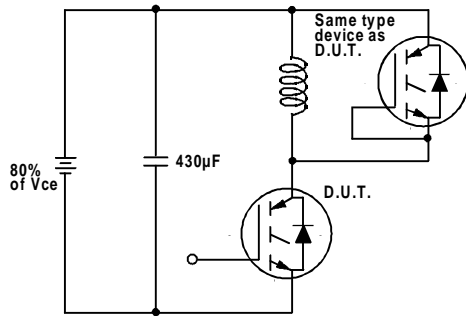

Fig. 18a - Test Circuit for Measurement of I_{LM} , E_{on} , $E_{off}(\text{diode})$, t_{rr} , Q_{rr} , I_{rr} , $t_{d(on)}$, t_r , $t_{d(off)}$, t_f

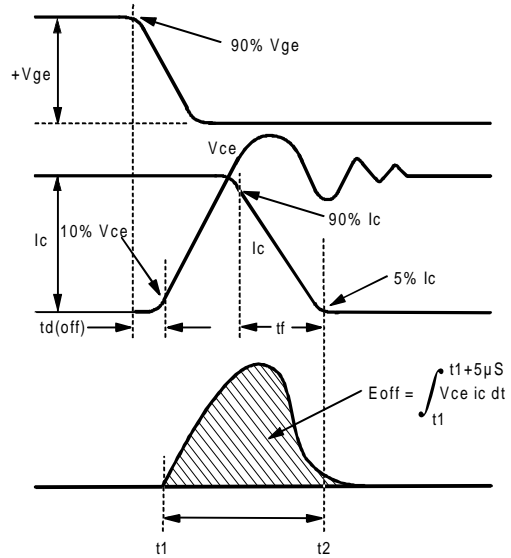

Fig. 18b - Test Waveforms for Circuit of Fig. 18a, Defining E_{off} , $t_{d(off)}$, t_f

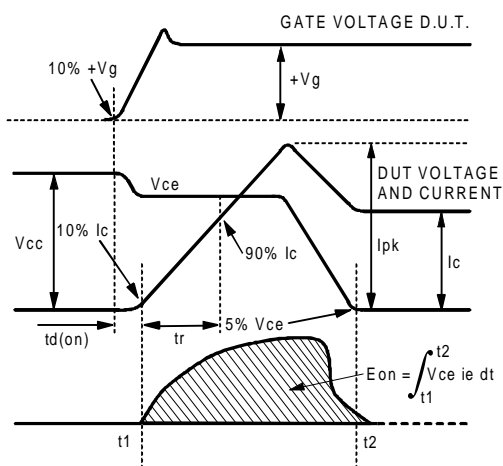

Fig. 18c - Test Waveforms for Circuit of Fig. 18a, Defining E_{on} , $t_{d(on)}$, t_r

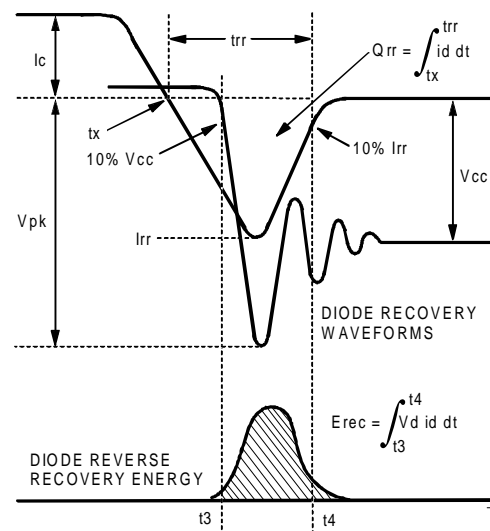

Fig. 18d - Test Waveforms for Circuit of Fig. 18a, Defining E_{rec} , t_{rr} , Q_{rr} , I_{rr}

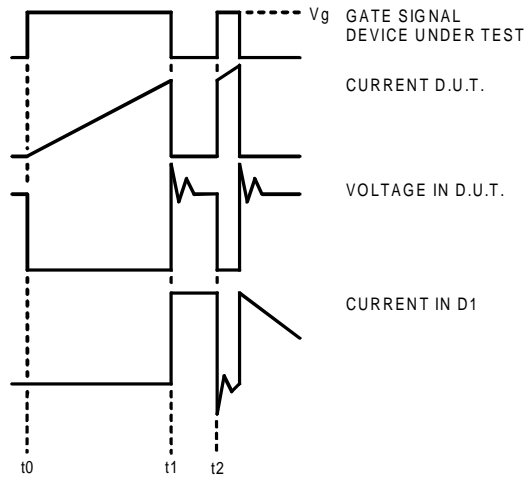

Figure 18e. Macro Waveforms for Figure 18a's Test Circuit

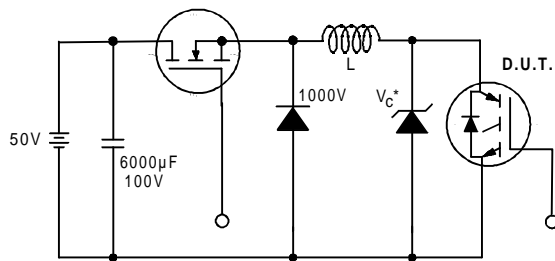

Figure 19. Clamped Inductive Load Test Circuit

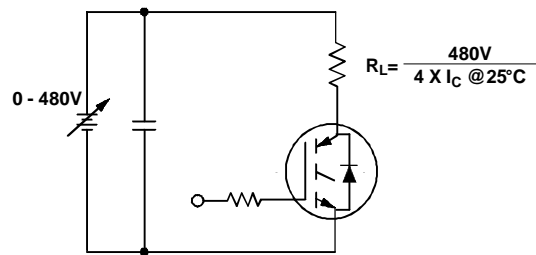
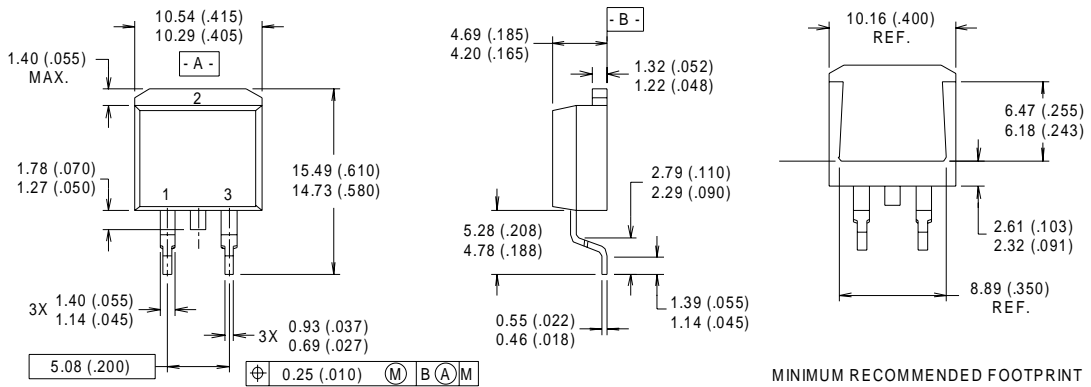

Figure 20. Pulsed Collector Current Test Circuit

IRG4BC20MD-S

International
IRF Rectifier

D²Pak Package Outline



- NOTES:
- 1 DIMENSIONS AFTER SOLDER DIP.
 - 2 DIMENSIONING & TOLERANCING PER ANSI Y14.5M, 1982.
 - 3 CONTROLLING DIMENSION : INCH.
 - 4 HEATSINK & LEAD DIMENSIONS DO NOT INCLUDE BURRS.

- LEAD ASSIGNMENTS
- 1 - GATE
 - 2 - DRAIN
 - 3 - SOURCE

D²Pak Part Marking Information

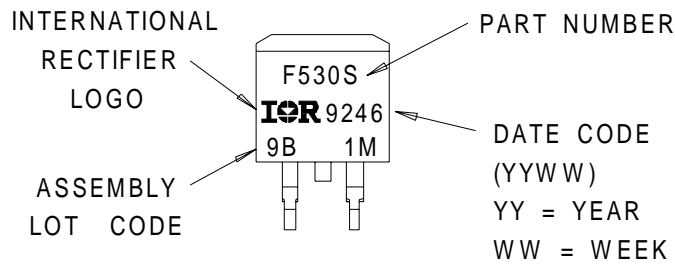

Notes:

- ① Repetitive rating: $V_{GE}=20V$; pulse width limited by maximum junction temperature (figure 20)
- ② $V_{CC}=80\%(V_{CES})$, $V_{GE}=20V$, $L=10\mu H$, $R_G = 50\Omega$ (figure 19)
- ③ Pulse width $\leq 80\mu s$; duty factor $\leq 0.1\%$.
- ④ Pulse width $5.0\mu s$, single shot.

D²Pak Tape & Reel Information

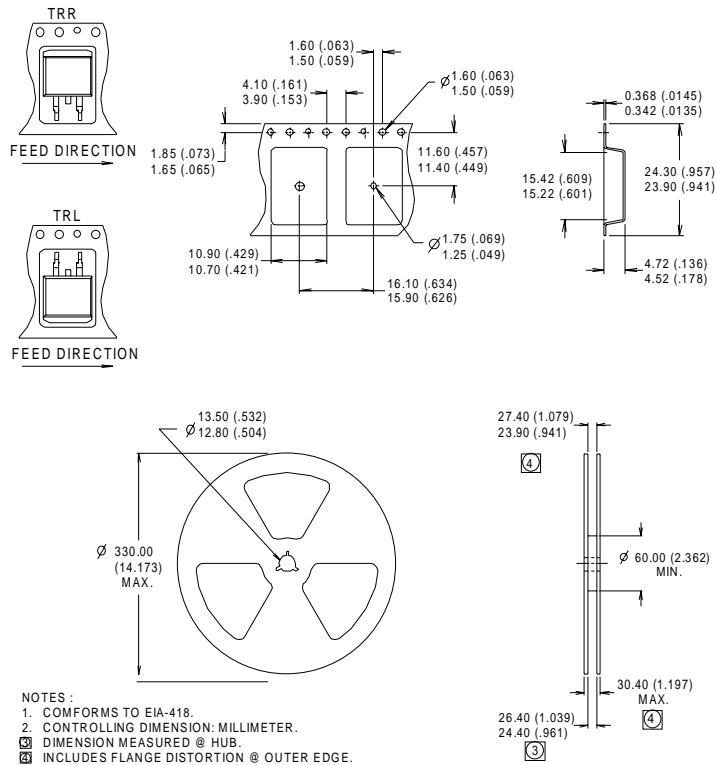

Data and specifications subject to change without notice.
 This product has been designed and qualified for the industrial market.
 Qualification Standards can be found on IR's Web site.