

# International IOR Rectifier

INSULATED GATE BIPOLAR TRANSISTOR

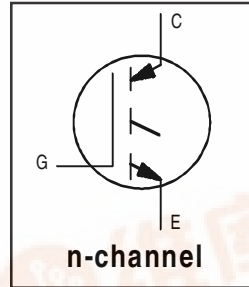
PD - 91448D

## IRG4BC20U

UltraFast Speed IGBT

### Features

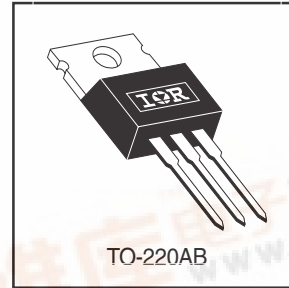
- UltraFast: optimized for high operating frequencies 8-40 kHz in hard switching, >200 kHz in resonant mode
- Generation 4 IGBT design provides tighter parameter distribution and higher efficiency than Generation 3
- Industry standard TO-220AB package



|                              |
|------------------------------|
| $V_{CES} = 600V$             |
| $V_{CE(on) typ.} = 1.85V$    |
| @ $V_{GE} = 15V, I_C = 6.5A$ |

### Benefits

- Generation 4 IGBTs offer highest efficiency available
- IGBTs optimized for specified application conditions
- Designed to be a "drop-in" replacement for equivalent industry-standard Generation 3 IR IGBTs



### Absolute Maximum Ratings

|                           | Parameter  | Max.                              | Units |
|---------------------------|--|-----------------------------------|-------|
| $V_{CES}$                 | Collector-to-Emitter Breakdown Voltage           | 600                               | V     |
| $I_C @ T_C = 25^\circ C$  | Continuous Collector Current                     | 13                                | A     |
| $I_C @ T_C = 100^\circ C$ | Continuous Collector Current                     | 6.5                               |       |
| $I_{CM}$                  | Pulsed Collector Current ①                       | 52                                |       |
| $I_{LM}$                  | Clamped Inductive Load Current ②                 | 52                                |       |
| $V_{GE}$                  | Gate-to-Emitter Voltage                          | $\pm 20$                          | V     |
| $E_{ARV}$                 | Reverse Voltage Avalanche Energy ③               | 5.0                               | mJ    |
| $P_D @ T_C = 25^\circ C$  | Maximum Power Dissipation                        | 60                                | W     |
| $P_D @ T_C = 100^\circ C$ | Maximum Power Dissipation                        | 24                                |       |
| $T_J$                     | Operating Junction and Storage Temperature Range | -55 to + 150                      | °C    |
| $T_{STG}$                 |  |                                   |       |
|                           | Soldering Temperature, for 10 seconds            | 300 (0.063 in. (1.6mm from case ) |       |
|                           | Mounting torque, 6-32 or M3 screw.               | 10 lbf•in (1.1N•m)                |       |

### Thermal Resistance

|                 | Parameter                                 | Typ.       | Max. | Units  |
|-----------------|---|------------|------|--------|
| $R_{\theta JC}$ | Junction-to-Case                          | —          | 2.1  | °C/W   |
| $R_{\theta CS}$ | Case-to-Sink, Flat, Greased Surface       | 0.50       | —    |        |
| $R_{\theta JA}$ | Junction-to-Ambient, typical socket mount | —          | 80   |        |
| Wt              | Weight                                    | 2.0 (0.07) | —    | g (oz) |



## Electrical Characteristics @ $T_J = 25^\circ\text{C}$ (unless otherwise specified)

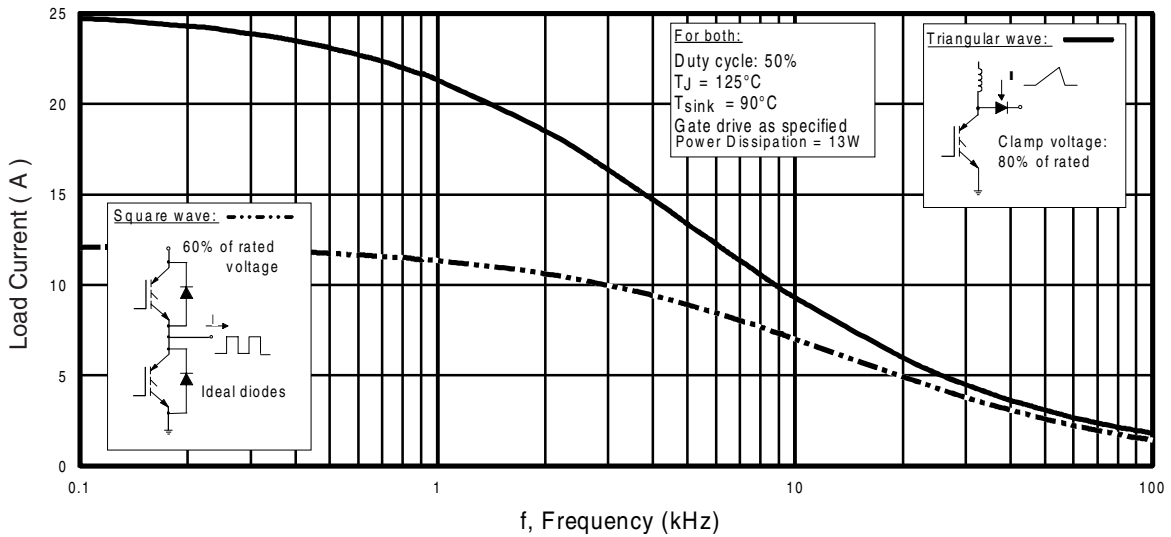
|                                 | Parameter                                | Min. | Typ. | Max.      | Units   | Conditions   |
|---------------------------------|--|------|------|-----------|---------|--|
| $V_{(BR)CES}$                   | Collector-to-Emitter Breakdown Voltage   | 600  | —    | —         | V       | $V_{GE} = 0V, I_C = 250\mu A$  |
| $V_{(BR)ECS}$                   | Emitter-to-Collector Breakdown Voltage ④ | 18   | —    | —         | V       | $V_{GE} = 0V, I_C = 1.0A$  |
| $\Delta V_{(BR)CES}/\Delta T_J$ | Temperature Coeff. of Breakdown Voltage  | —    | 0.69 | —         | V/°C    | $V_{GE} = 0V, I_C = 1.0mA$   |
| $V_{CE(ON)}$                    | Collector-to-Emitter Saturation Voltage  | —    | 1.85 | 2.1       | V       | $I_C = 6.5A, V_{GE} = 15V$<br>See Fig.2, 5   |
|                                 |  | —    | 2.27 | —         |         |  |
|                                 |  | —    | 1.87 | —         |         |  |
| $V_{GE(th)}$                    | Gate Threshold Voltage                   | 3.0  | —    | 6.0       |         | $I_C = 6.5A, T_J = 150^\circ\text{C}$<br>$V_{CE} = V_{GE}, I_C = 250\mu A$   |
| $\Delta V_{GE(th)}/\Delta T_J$  | Temperature Coeff. of Threshold Voltage  | —    | -11  | —         | mV/°C   | $V_{CE} = V_{GE}, I_C = 250\mu A$  |
| $g_{fe}$                        | Forward Transconductance ⑤               | 1.4  | 4.3  | —         | S       | $V_{CE} = 100V, I_C = 6.5A$  |
| $I_{CES}$                       | Zero Gate Voltage Collector Current      | —    | —    | 250       | $\mu A$ | $V_{GE} = 0V, V_{CE} = 600V$<br>$V_{GE} = 0V, V_{CE} = 10V, T_J = 25^\circ\text{C}$<br>$V_{GE} = 0V, V_{CE} = 600V, T_J = 150^\circ\text{C}$ |
|                                 |  | —    | —    | 2.0       |         |  |
|                                 |  | —    | —    | 1000      |         |  |
| $I_{GES}$                       | Gate-to-Emitter Leakage Current          | —    | —    | $\pm 100$ | nA      | $V_{GE} = \pm 20V$   |

## Switching Characteristics @ $T_J = 25^\circ\text{C}$ (unless otherwise specified)

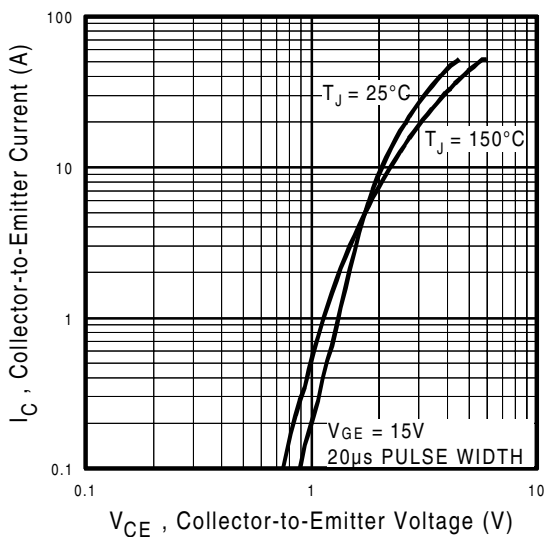
|              | Parameter                         | Min. | Typ. | Max. | Units | Conditions   |
|--------------|-----------------------------------|------|------|------|-------|--|
| $Q_g$        | Total Gate Charge (turn-on)       | —    | 27   | 41   | nC    | $I_C = 6.5A$<br>$V_{CC} = 400V$ See Fig. 8<br>$V_{GE} = 15V$   |
| $Q_{ge}$     | Gate - Emitter Charge (turn-on)   | —    | 4.5  | 6.8  |       |  |
| $Q_{gc}$     | Gate - Collector Charge (turn-on) | —    | 10   | 16   |       |  |
| $t_{d(on)}$  | Turn-On Delay Time                | —    | 21   | —    | ns    | $T_J = 25^\circ\text{C}$<br>$I_C = 6.5A, V_{CC} = 480V$<br>$V_{GE} = 15V, R_G = 50\Omega$<br>Energy losses include "tail"<br>See Fig. 10, 11, 13, 14 |
| $t_r$        | Rise Time                         | —    | 13   | —    |       |  |
| $t_{d(off)}$ | Turn-Off Delay Time               | —    | 86   | 130  |       |  |
| $t_f$        | Fall Time                         | —    | 120  | 180  |       |  |
| $E_{on}$     | Turn-On Switching Loss            | —    | 0.10 | —    | mJ    | See Fig. 13, 14  |
| $E_{off}$    | Turn-Off Switching Loss           | —    | 0.12 | —    |       |  |
| $E_{ts}$     | Total Switching Loss              | —    | 0.22 | 0.4  |       |  |
| $t_{d(on)}$  | Turn-On Delay Time                | —    | 20   | —    | ns    | $T_J = 150^\circ\text{C}$ ,<br>$I_C = 6.5A, V_{CC} = 480V$<br>$V_{GE} = 15V, R_G = 50\Omega$<br>Energy losses include "tail"<br>See Fig. 13, 14      |
| $t_r$        | Rise Time                         | —    | 14   | —    |       |  |
| $t_{d(off)}$ | Turn-Off Delay Time               | —    | 190  | —    |       |  |
| $t_f$        | Fall Time                         | —    | 140  | —    |       |  |
| $E_{ts}$     | Total Switching Loss              | —    | 0.42 | —    | mJ    |  |
| $L_E$        | Internal Emitter Inductance       | —    | 7.5  | —    | nH    | Measured 5mm from package  |
| $C_{ies}$    | Input Capacitance                 | —    | 530  | —    | pF    | $V_{GE} = 0V$<br>$V_{CC} = 30V$ See Fig. 7<br>$f = 1.0MHz$   |
| $C_{oes}$    | Output Capacitance                | —    | 39   | —    |       |  |
| $C_{res}$    | Reverse Transfer Capacitance      | —    | 7.4  | —    |       |  |

### Notes:

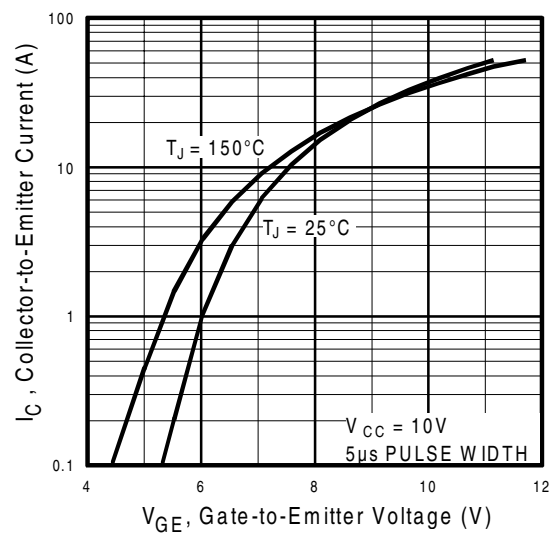
- ① Repetitive rating;  $V_{GE} = 20V$ , pulse width limited by max. junction temperature. ( See fig. 13b )
- ②  $V_{CC} = 80\%(V_{CES}), V_{GE} = 20V, L = 10\mu H, R_G = 50\Omega$ , (See fig. 13a)
- ③ Repetitive rating; pulse width limited by maximum junction temperature.
- ④ Pulse width  $\leq 80\mu s$ ; duty factor  $\leq 0.1\%$ .
- ⑤ Pulse width  $5.0\mu s$ , single shot.



**Fig. 1 - Typical Load Current vs. Frequency**  
(For square wave,  $I = I_{RMS}$  of fundamental; for triangular wave,  $I = I_{PK}$ )



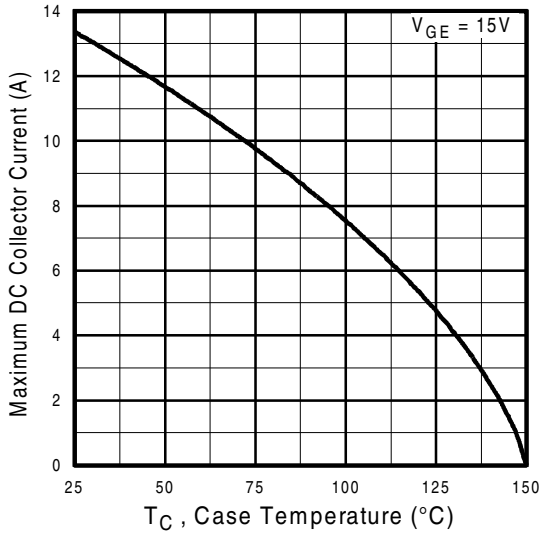
**Fig. 2 - Typical Output Characteristics**



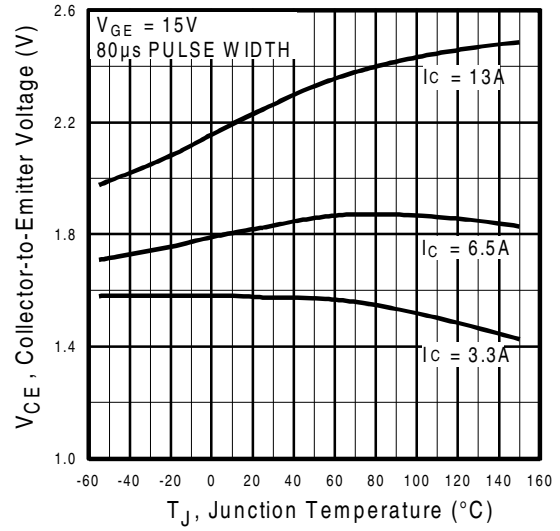
**Fig. 3 - Typical Transfer Characteristics**

# IRG4BC20U

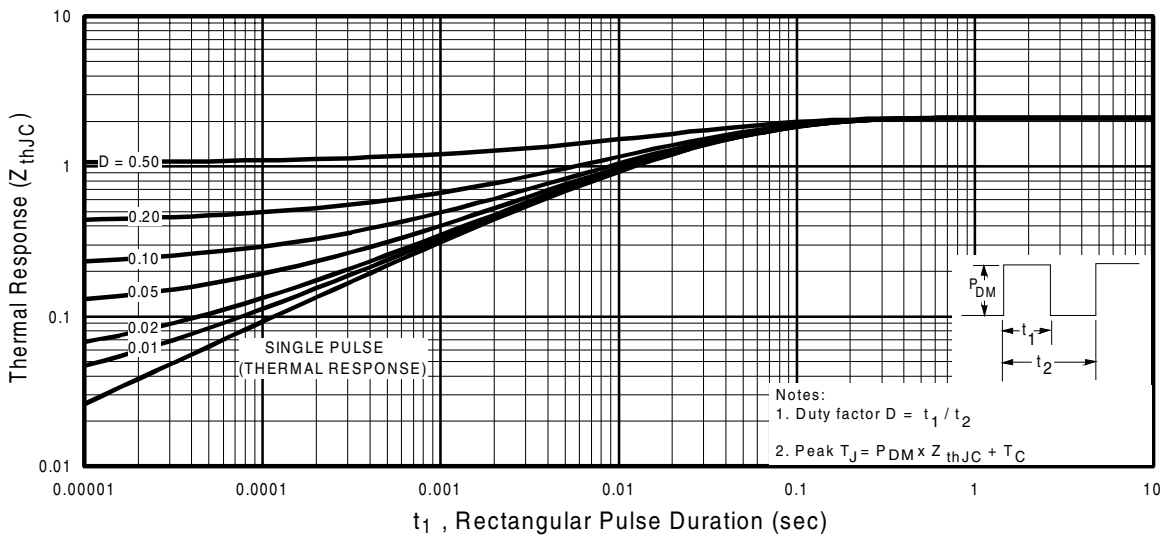
International  
**IR** Rectifier



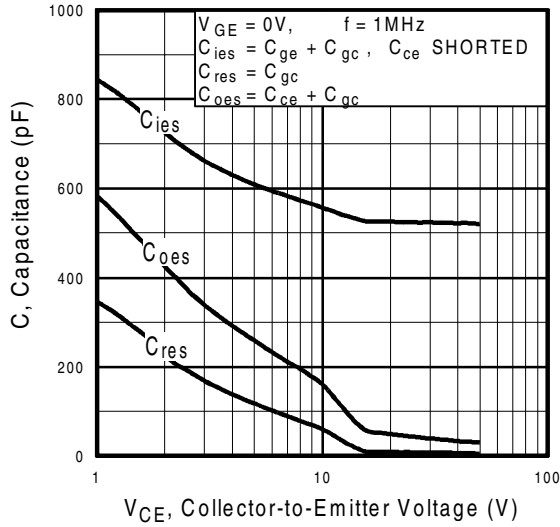
**Fig. 4** - Maximum Collector Current vs. Case Temperature



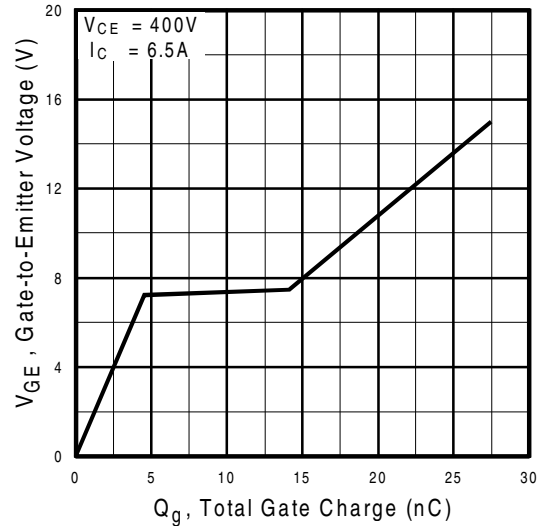
**Fig. 5** - Collector-to-Emitter Voltage vs. Junction Temperature



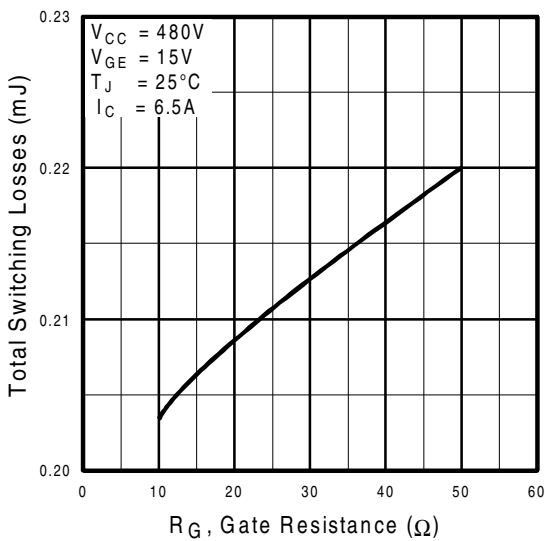
**Fig. 6** - Maximum Effective Transient Thermal Impedance, Junction-to-Case



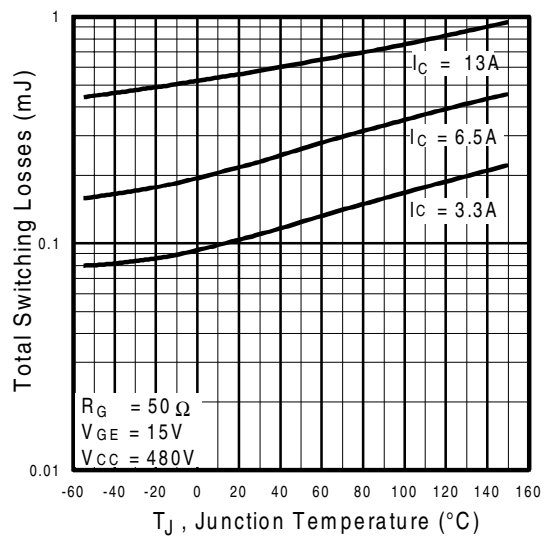
**Fig. 7 - Typical Capacitance vs. Collector-to-Emitter Voltage**



**Fig. 8 - Typical Gate Charge vs. Gate-to-Emitter Voltage**

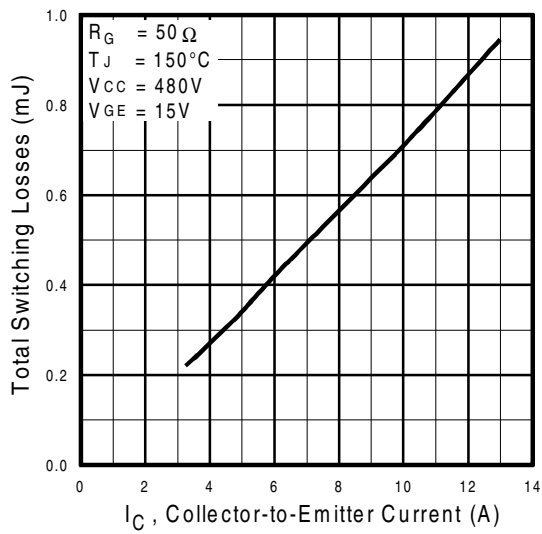


**Fig. 9 - Typical Switching Losses vs. Gate Resistance**

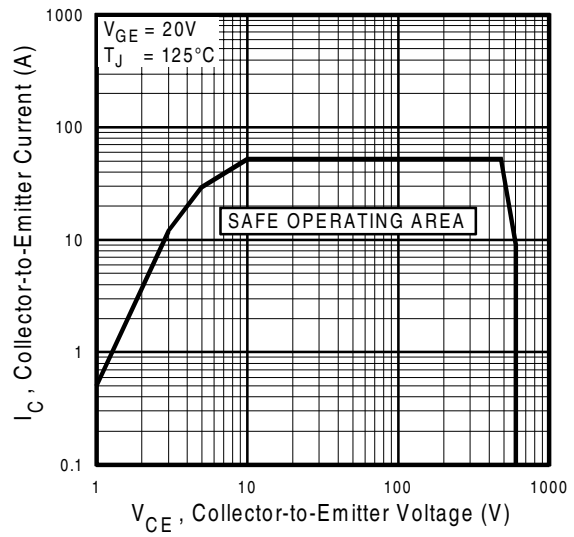


**Fig. 10 - Typical Switching Losses vs. Junction Temperature**

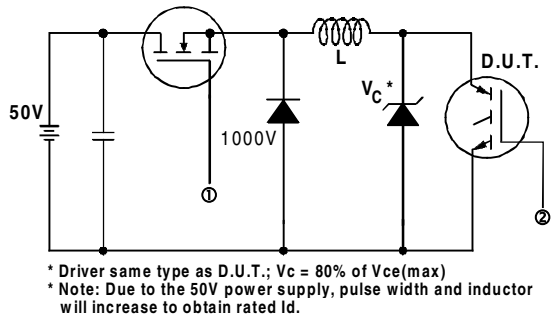
# IRG4BC20U



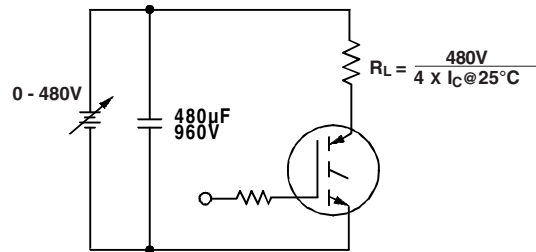
**Fig. 11** - Typical Switching Losses vs. Collector-to-Emitter Current



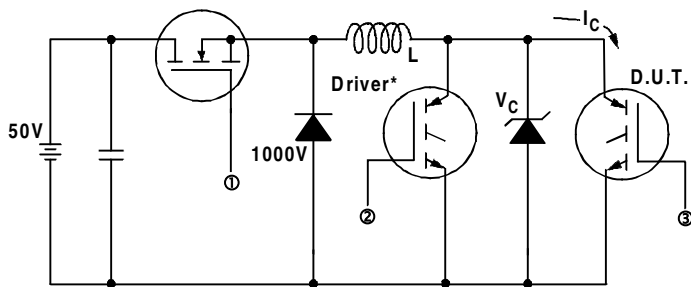
**Fig. 12** - Turn-Off SOA



**Fig. 13a** - Clamped Inductive Load Test Circuit

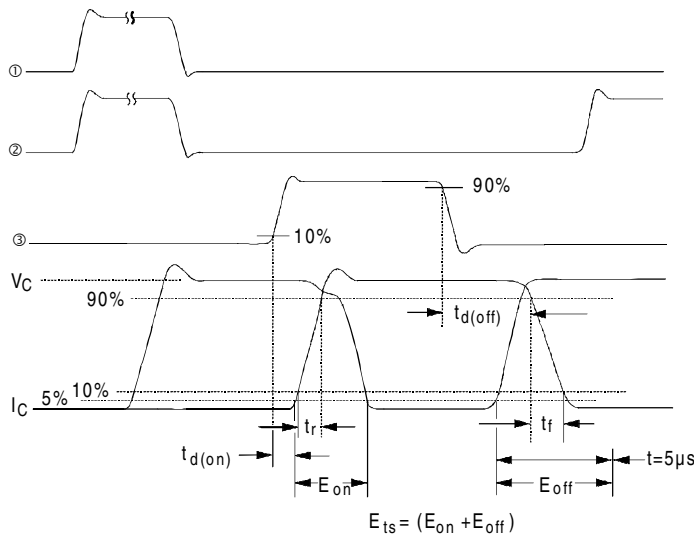


**Fig. 13b** - Pulsed Collector Current Test Circuit



**Fig. 14a** - Switching Loss Test Circuit

\* Driver same type as D.U.T.,  $V_C = 480V$

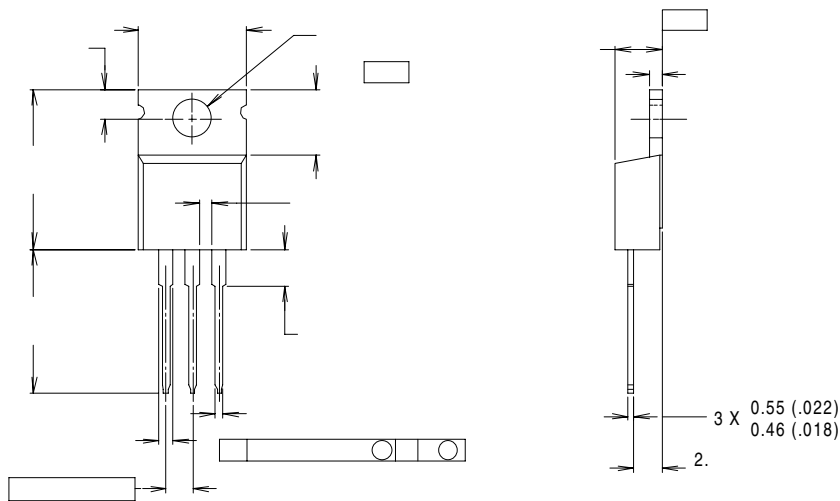


**Fig. 14b** - Switching Loss Waveforms

# IRG4BC20U

International  
**IR** Rectifier

## Case Outline and Dimensions — TO-220AB



International  
**IR** Rectifier

**IR WORLD HEADQUARTERS:** 233 Kansas St., El Segundo, California 90245, USA Tel: (310) 252-7105  
**IR EUROPEAN REGIONAL CENTRE:** 439/445 Godstone Rd, Whyteleafe, Surrey CR3 0BL, UK Tel: ++ 44 (0)20 8645 8000  
**IR CANADA:** 15 Lincoln Court, Brampton, Ontario L6T3Z2, Tel: (905) 453 2200  
**IR GERMANY:** Saalburgstrasse 157, 61350 Bad Homburg Tel: ++ 49 (0) 6172 96590  
**IR ITALY:** Via Liguria 49, 10071 Borgaro, Torino Tel: ++ 39 011 451 0111  
**IR JAPAN:** K&H Bldg., 2F, 30-4 Nishi-Ikebukuro 3-Chome, Toshima-Ku, Tokyo 171 Tel: 81 (0)3 3983 0086  
**IR SOUTHEAST ASIA:** 1 Kim Seng Promenade, Great World City West Tower, 13-11, Singapore 237994 Tel: ++ 65 (0)838 4630  
**IR TAIWAN:** 16 Fl. Suite D. 207, Sec. 2, Tun Haw South Road, Taipei, 10673 Tel: 886-(0)2 2377 9936  
*Data and specifications subject to change without notice. 4/00*