

International
IR Rectifier
**RADIATION HARDENED
 POWER MOSFET
 THRU-HOLE (Low-Ohmic TO-254AA)**

PD-95871

**IRHMS57264SE
 JANSR2N7477T1
 250V, N-CHANNEL
 REF: MIL-PRF-19500/685
 R5 TECHNOLOGY**

Product Summary

Part Number	Radiation Level	R _{DS(on)}	ID	QPL Part Number
IRHMS57264SE	100K Rads (Si)	0.061Ω	37A	JANSR2N7477T1



International Rectifier's R5™ technology provides high performance power MOSFETs for space applications. These devices have been characterized for Single Event Effects (SEE) with useful performance up to an LET of 80 (MeV/(mg/cm²)). The combination of low R_{DS(on)} and low gate charge reduces the power losses in switching applications such as DC to DC converters and motor control. These devices retain all of the well established advantages of MOSFETs such as voltage control, fast switching, ease of paralleling and temperature stability of electrical parameters.

Features:

- Low R_{DS(on)}
- Fast Switching
- Single Event Effect (SEE) Hardened
- Low Total Gate Charge
- Simple Drive Requirements
- Ease of Paralleling
- Hermetically Sealed
- Ceramic Eyelets
- Electrically Isolated
- Light Weight

Absolute Maximum Ratings

Pre-Irradiation

	Parameter		Units
ID @ VGS = 12V, TC = 25°C	Continuous Drain Current	37	A
ID @ VGS = 12V, TC = 100°C	Continuous Drain Current	23.5	
IDM	Pulsed Drain Current ①	148	
PD @ TC = 25°C	Max. Power Dissipation	208	W
	Linear Derating Factor	1.67	W/°C
VGS	Gate-to-Source Voltage	±20	V
EAS	Single Pulse Avalanche Energy ②	258	mJ
IAR	Avalanche Current ①	37	A
EAR	Repetitive Avalanche Energy ①	20.8	mJ
dv/dt	Peak Diode Recovery dv/dt ③	14	V/ns
TJ	Operating Junction	-55 to 150	°C
TSTG	Storage Temperature Range		
	Lead Temperature	300 (0.063 in.(1.6 mm from case for 10s))	
	Weight	9.3 (Typical)	g

For footnotes refer to the last page

www.irf.com



Electrical Characteristics @ T_j = 25°C (Unless Otherwise Specified)

	Parameter	Min	Typ	Max	Units	Test Conditions
BV _{DSS}	Drain-to-Source Breakdown Voltage	250	—	—	V	V _{GS} = 0V, I _D = 1.0mA
ΔBV _{DSS} /ΔT _J	Temperature Coefficient of Breakdown Voltage	—	0.29	—	V/°C	Reference to 25°C, I _D = 1.0mA
R _{DS(on)}	Static Drain-to-Source On-State Resistance	—	—	0.061	Ω	V _{GS} = 12V, I _D = 23.5A ④
V _{GS(th)}	Gate Threshold Voltage	2.5	—	4.5	V	V _{DS} = V _{GS} , I _D = 1.0mA
g _{fs}	Forward Transconductance	27	—	—	S (Ω)	V _{DS} = 15V, I _{DS} = 23.5A ④
I _{DSS}	Zero Gate Voltage Drain Current	—	—	10	μA	V _{DS} = 200V, V _{GS} = 0V
		—	—	25		V _{DS} = 200V, V _{GS} = 0V, T _J = 125°C
I _{GSS}	Gate-to-Source Leakage Forward	—	—	100	nA	V _{GS} = 20V
I _{GSS}	Gate-to-Source Leakage Reverse	—	—	-100		V _{GS} = -20V
Q _g	Total Gate Charge	—	—	165	nC	V _{GS} = 12V, I _D = 37A V _{DS} = 125V
Q _{gs}	Gate-to-Source Charge	—	—	45		
Q _{gd}	Gate-to-Drain ('Miller') Charge	—	—	75		
t _{d(on)}	Turn-On Delay Time	—	—	35		
t _r	Rise Time	—	—	125	ns	V _{DD} = 125V, I _D = 37A V _{GS} = 12V, R _G = 2.35Ω
t _{d(off)}	Turn-Off Delay Time	—	—	80		
t _f	Fall Time	—	—	65		
L _S + L _D	Total Inductance	—	6.8	—	nH	Measured from Drain lead (6mm /0.25in. from package) to Source lead (6mm /0.25in from package) with Source wires internally bonded from Source Pin to Drain Pad
C _{iss}	Input Capacitance	—	5410	—	pF	V _{GS} = 0V, V _{DS} = 25V f = 1.0MHz
C _{oss}	Output Capacitance	—	770	—		
C _{rss}	Reverse Transfer Capacitance	—	36	—		
R _g	Internal Gate Resistance	—	1.2	—	Ω	f = 1.0MHz, open drain

Source-Drain Diode Ratings and Characteristics

	Parameter	Min	Typ	Max	Units	Test Conditions
I _S	Continuous Source Current (Body Diode)	—	—	37	A	
I _{SM}	Pulse Source Current (Body Diode) ①	—	—	148		
V _{SD}	Diode Forward Voltage	—	—	1.2	V	T _j = 25°C, I _S = 37A, V _{GS} = 0V ④
t _{rr}	Reverse Recovery Time	—	—	560	ns	T _j = 25°C, I _F = 37A, di/dt ≤ 100A/μs
Q _{RR}	Reverse Recovery Charge	—	—	8.2	μC	V _{DD} ≤ 50V ④
t _{on}	Forward Turn-On Time	Intrinsic turn-on time is negligible. Turn-on speed is substantially controlled by L _S + L _D .				

Thermal Resistance

	Parameter	Min	Typ	Max	Units	Test Conditions
R _{thJC}	Junction-to-Case	—	—	0.60	°C/W	Typical socket mount
R _{thCS}	Case-to-Sink	—	0.21	—		
R _{thJA}	Junction-to-Ambient	—	—	48		

Note: Corresponding Spice and Saber models are available on International Rectifier Web site.

For footnotes refer to the last page

Radiation Characteristics

IRHMS57264SE, JANSR2N777T1

International Rectifier Radiation Hardened MOSFETs are tested to verify their radiation hardness capability. The hardness assurance program at International Rectifier is comprised of two radiation environments. Every manufacturing lot is tested for total ionizing dose (per notes 5 and 6) using the TO-3 package. Both pre- and post-irradiation performance are tested and specified using the same drive circuitry and test conditions in order to provide a direct comparison.

Table 1. Electrical Characteristics @ T_j = 25°C, Post Total Dose Irradiation ⑤⑥

	Parameter	100K Rads (Si)		Units	Test Conditions ⑧
		Min	Max		
BV _{DSS}	Drain-to-Source Breakdown Voltage	250	—	V	V _{GS} = 0V, I _D = 1.0mA
V _{GS(th)}	Gate Threshold Voltage	2.0	4.5		V _{GS} = V _{DS} , I _D = 1.0mA
I _{GSS}	Gate-to-Source Leakage Forward	—	100	nA	V _{GS} = 20V
I _{GSS}	Gate-to-Source Leakage Reverse	—	-100		V _{GS} = -20V
I _{DSS}	Zero Gate Voltage Drain Current	—	10	μA	V _{DS} = 200V, V _{GS} = 0V
R _{DS(on)}	Static Drain-to-Source On-State Resistance (TO-3) ④	—	0.061	Ω	V _{GS} = 12V, I _D = 23.5A
R _{DS(on)}	Static Drain-to-Source On-state Resistance (Low-Ohmic TO-254) ④	—	0.061	Ω	V _{GS} = 12V, I _D = 23.5A
V _{SD}	Diode Forward Voltage ④	—	1.2	V	V _{GS} = 0V, I _D = 37A

International Rectifier radiation hardened MOSFETs have been characterized in heavy ion environment for Single Event Effects (SEE). Single Event Effects characterization is illustrated in Fig. a and Table 2.

Table 2. Single Event Effect Safe Operating Area

Ion	LET MeV/(mg/cm ²)	Energy (MeV)	Range (μm)	V _{DS} (V)				
				@V _{GS} =0V	@V _{GS} =-5V	@V _{GS} =-10V	@V _{GS} =-15V	@V _{GS} =-20V
Br	36.7	309	39.5	250	250	250	250	250
I	59.8	341	32.5	250	250	250	250	240
Au	82.3	350	28.4	250	250	225	175	80

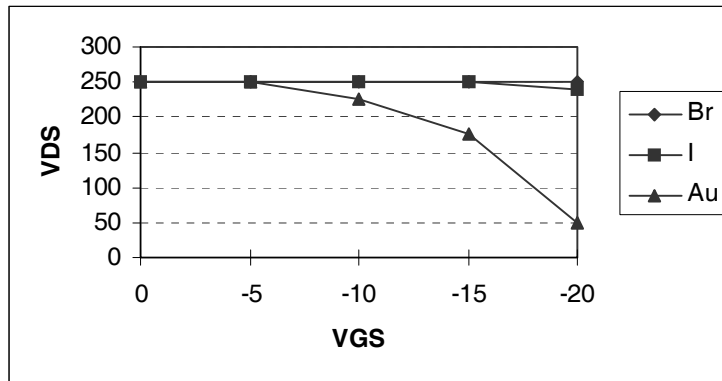

Fig a. Single Event Effect, Safe Operating Area

For footnotes refer to the last page

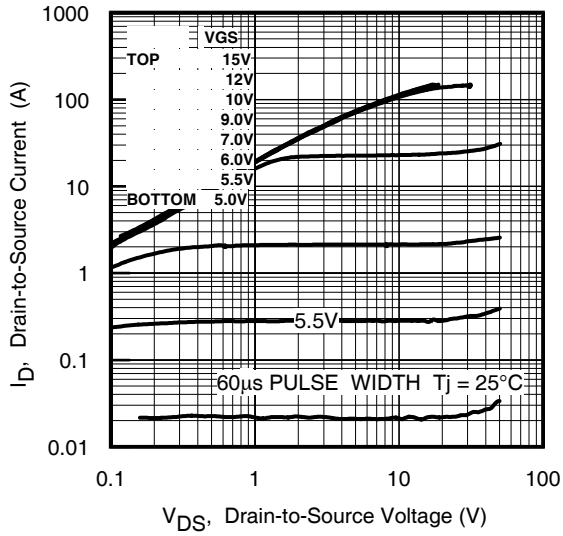

Fig 1. Typical Output Characteristics

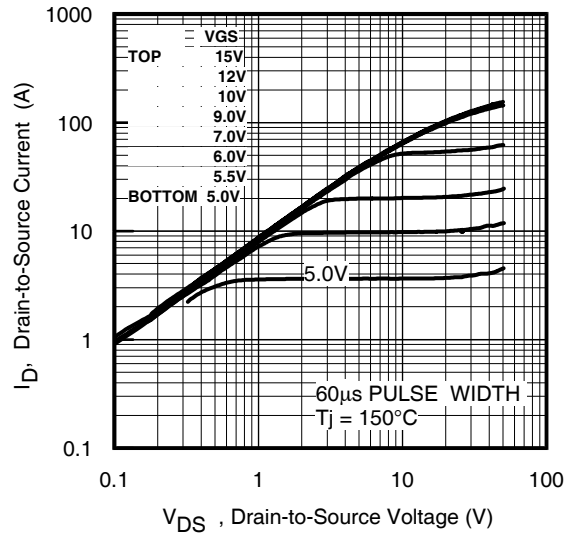

Fig 2. Typical Output Characteristics

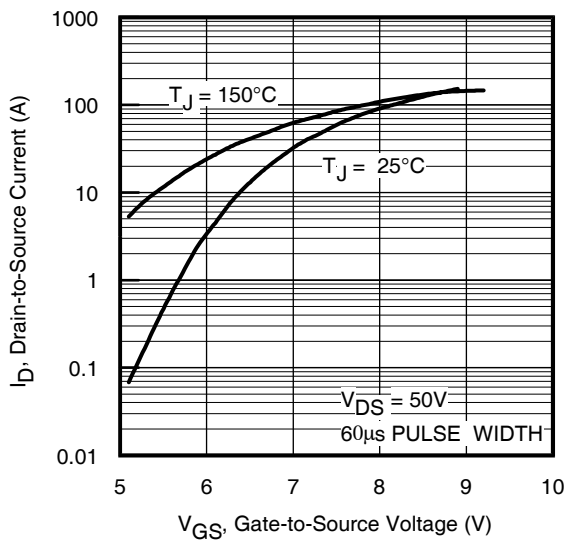

Fig 3. Typical Transfer Characteristics

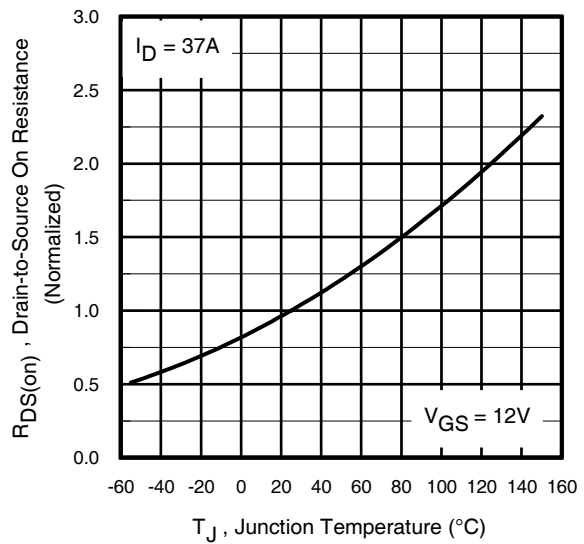

Fig 4. Normalized On-Resistance Vs. Temperature

Pre-Irradiation

IRHMS57264SE, JANSR2N777T1

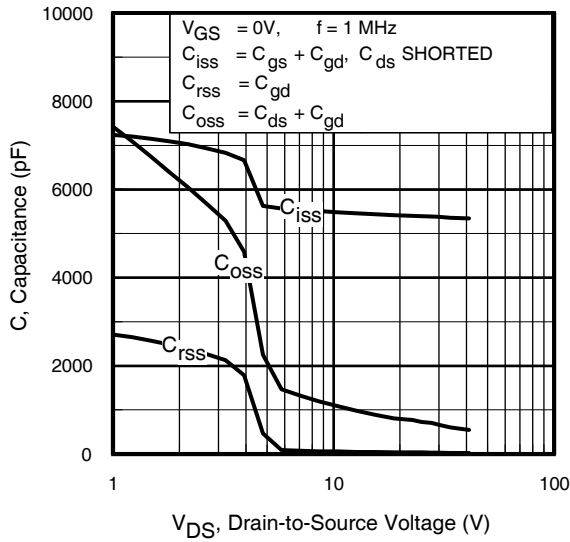

Fig 5. Typical Capacitance Vs. Drain-to-Source Voltage

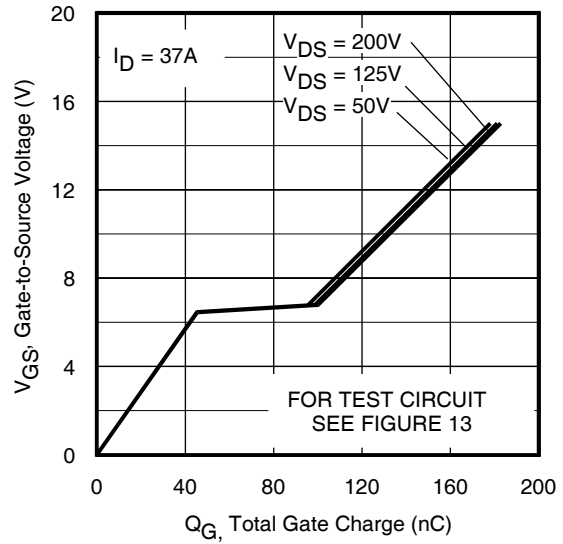

Fig 6. Typical Gate Charge Vs. Gate-to-Source Voltage

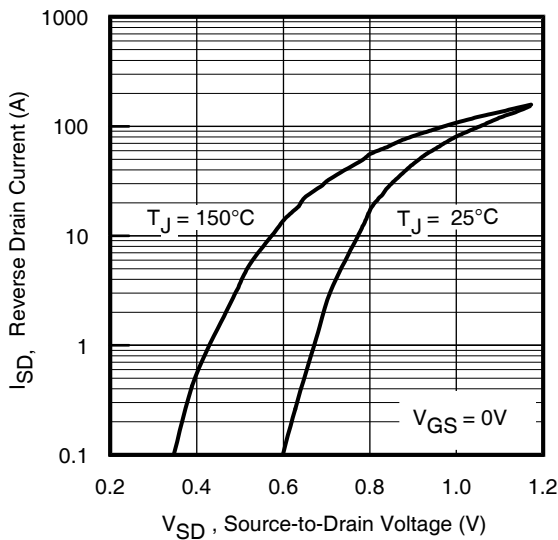

Fig 7. Typical Source-Drain Diode Forward Voltage

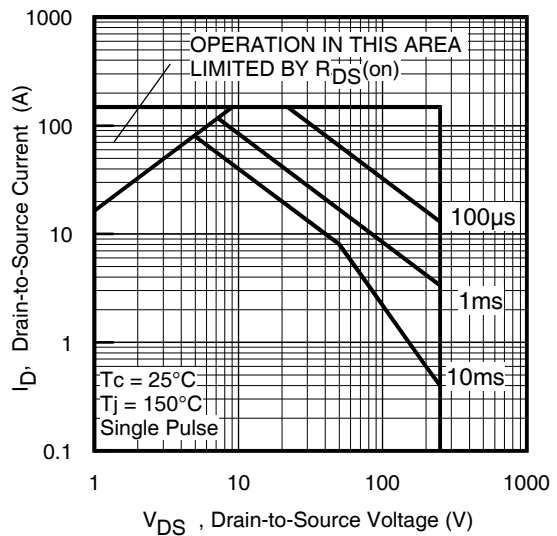

Fig 8. Maximum Safe Operating Area

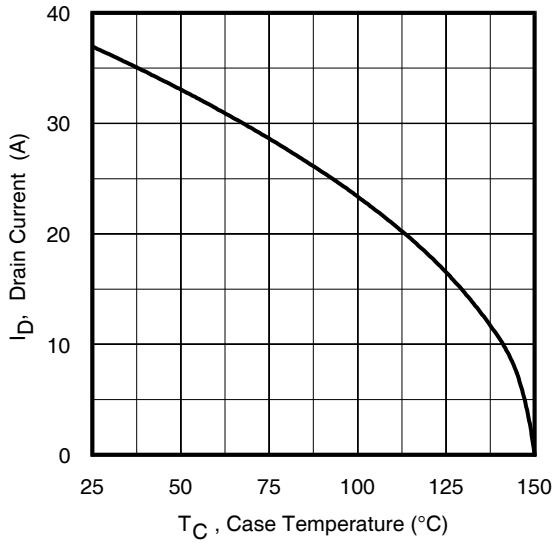

Fig 9. Maximum Drain Current Vs. Case Temperature

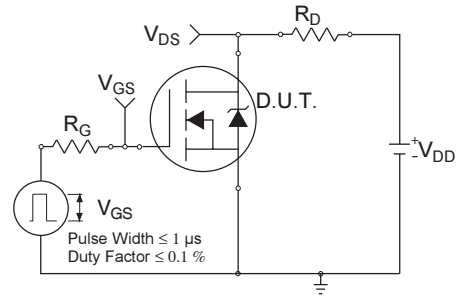

Fig 10a. Switching Time Test Circuit

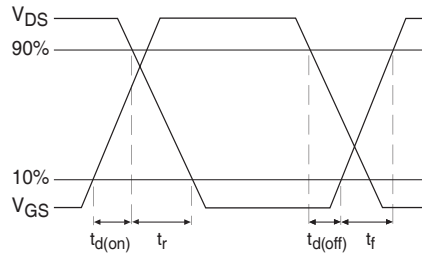

Fig 10b. Switching Time Waveforms

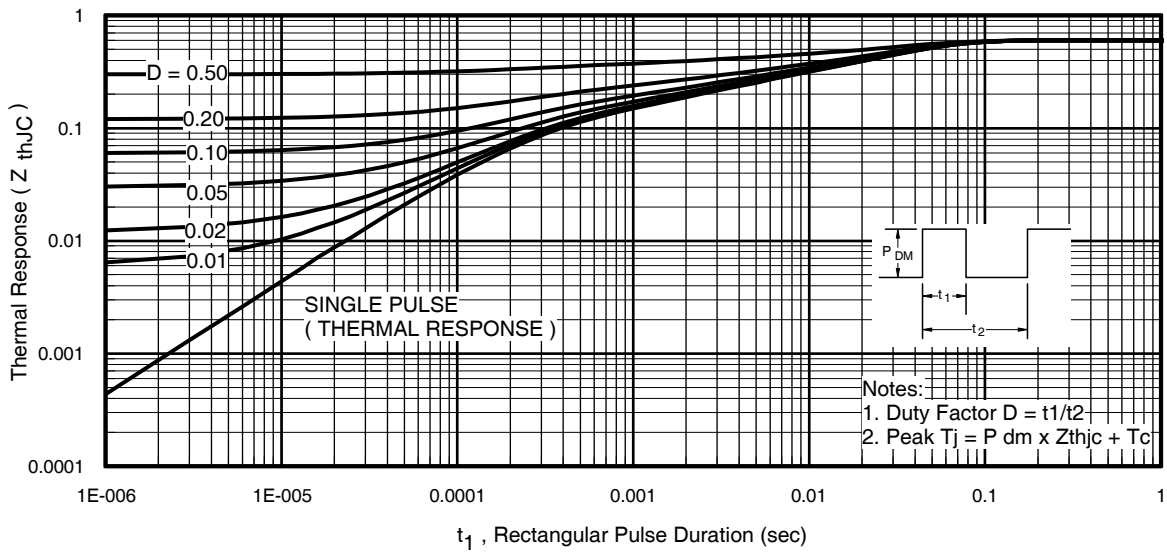

Fig 11. Maximum Effective Transient Thermal Impedance, Junction-to-Case

Pre-Irradiation

IRHMS57264SE, JANSR2N777T1

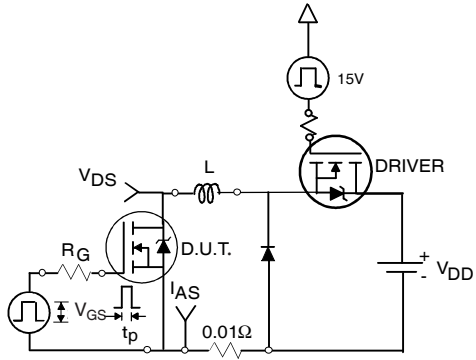

Fig 12a. Unclamped Inductive Test Circuit

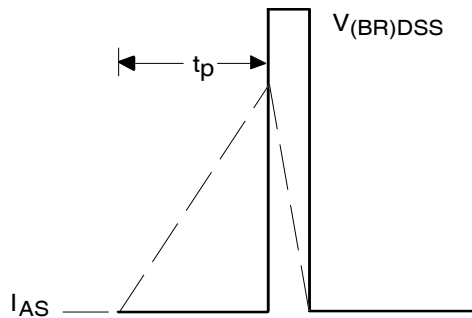

Fig 12b. Unclamped Inductive Waveforms

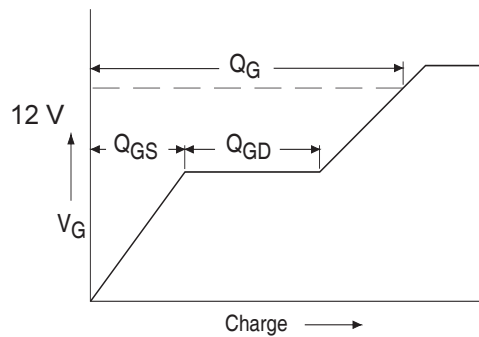

Fig 13a. Basic Gate Charge Waveform

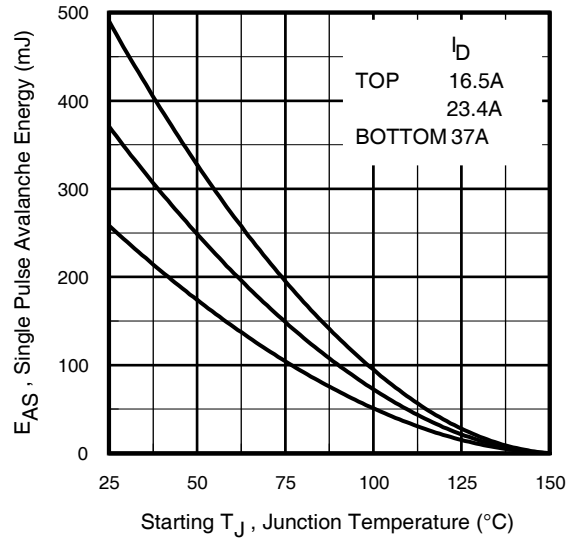

Fig 12c. Maximum Avalanche Energy Vs. Drain Current

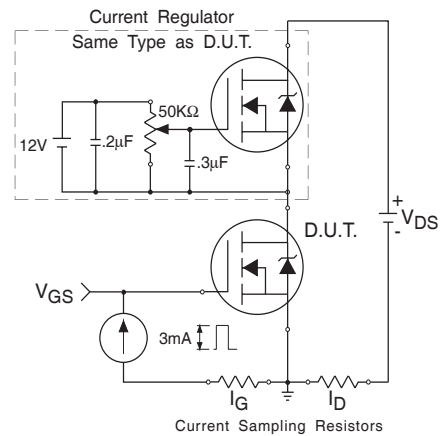

Fig 13b. Gate Charge Test Circuit

IRHMS57264SE, JANSR2N7477T1

Pre-Irradiation

Footnotes:

- ① Repetitive Rating; Pulse width limited by maximum junction temperature.
- ② $V_{DD} = 50V$, starting $T_J = 25^\circ C$, $L = 0.38mH$
Peak $I_L = 37A$, $V_{GS} = 12V$
- ③ $I_{SD} \leq 37A$, $di/dt \leq 1040A/\mu s$,
 $V_{DD} \leq 250V$, $T_J \leq 150^\circ C$
- ④ Pulse width $\leq 300 \mu s$; Duty Cycle $\leq 2\%$
- ⑤ **Total Dose Irradiation with V_{GS} Bias.**
12 volt V_{GS} applied and $V_{DS} = 0$ during irradiation per MIL-STD-750, method 1019, condition A.
- ⑥ **Total Dose Irradiation with V_{DS} Bias.**
200 volt V_{DS} applied and $V_{GS} = 0$ during irradiation per MIL-STD-750, method 1019, condition A.

Case Outline and Dimensions — Low-Ohmic TO-254AA

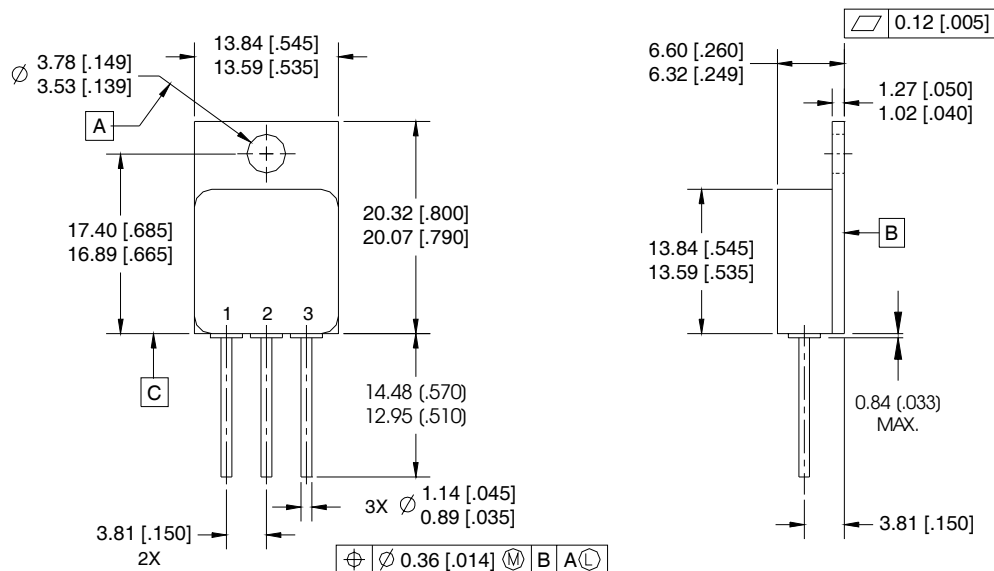

NOTES:

1. DIMENSIONING & TOLERANCING PER ASME Y14.5M-1994.
2. ALL DIMENSIONS ARE SHOWN IN MILLIMETERS [INCHES].
3. CONTROLLING DIMENSION: INCH.
4. CONFORMS TO JEDEC OUTLINE TO-254AA.

PIN ASSIGNMENTS

- 1 = DRAIN
- 2 = SOURCE
- 3 = GATE

CAUTION

BERYLLIA WARNING PER MIL-PRF-19500

Package containing beryllia shall not be ground, sandblasted, machined, or have other operations performed on them which will produce beryllia or beryllium dust. Furthermore, beryllium oxide packages shall not be placed in acids that will produce fumes containing beryllium.

International
IR Rectifier

IR WORLD HEADQUARTERS: 233 Kansas St., El Segundo, California 90245, USA Tel: (310) 252-7105

IR LEOMINSTER : 205 Crawford St., Leominster, Massachusetts 01453, USA Tel: (978) 534-5776

TAC Fax: (310) 252-7903

Visit us at www.irf.com for sales contact information.

Data and specifications subject to change without notice. 11/2004