

International IOR Rectifier

Data Sheet No. PD60196

IRIS4009(K)

INTEGRATED SWITCHER

Features

- Primary current mode control, and secondary voltage mode control
- Vcc Over-voltage protection (latched)
- Over-current & over-temperature protection
- Quasi resonant, variable frequency operation
- 5 pin TO-220 and TO-262
- 8.0Ω Rds(on) max/ 650V MOSFET
- **Fully Characterized Avalanche Energy**

Packages

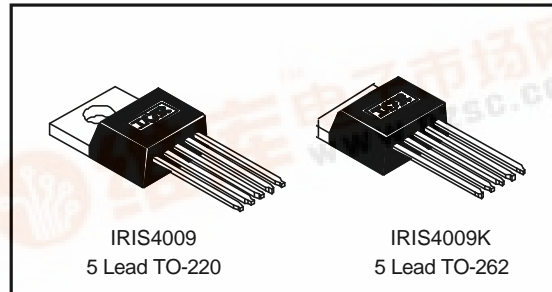

Description

The IRIS4009(K) is a dual mode voltage and current controller combined with a MOSFET in a single package. The IRIS4009(K) is designed for use in universal and single input AC/DC and DC/DC switching power supplies and is capable of powers up to 30W for a universal line input. The device can operate in either a quasi-resonant or Pulse Ratio Control (PRC) mode, and thereby variable frequency operation.

Typical Connection Diagram

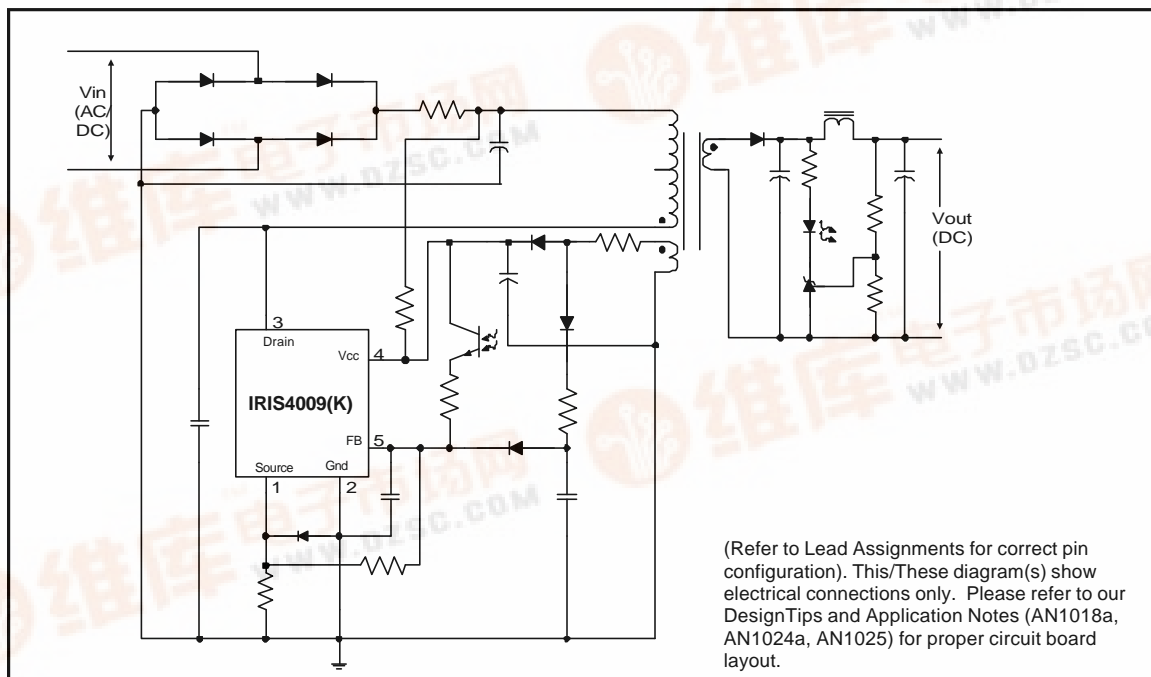

IRIS4009(K)

Absolute Maximum Ratings

Absolute maximum ratings indicate sustained limits beyond which damage to the device may occur. All voltage parameters are absolute voltages referenced to terminals stated, all currents are defined positive into any lead. The thermal resistance and power dissipation ratings are measured under board mounted and still air conditions.

Symbol	Definition	Terminals	Max. Ratings	Units	Note
I_{Dpeak}	Peak drain current	3-1	3.9	A	Single pulse
I_{Dmax}	Maximum switching current	3-1	1.5		$V_{2-3} = 0.78V$ $T_C = 25^\circ C$
E_{AS}	Single pulse avalanche energy	3-1	100	mJ	$V_{dd} = 50V, L = 20mH,$ $G = 12V, I_{pk} = 1.5A$
V_{CC}	Power supply voltage	4-3	35	V	
V_{TH}	OCP/FB terminal voltage	5-2	6		
P_{D1}	Power dissipation for MOSFET	3-1	62.5	W	With infinite heatsink
			1.1		Without heatsink
P_{D2}	Power dissipation for control part (MIC)	4-2	0.8		Specified by $V_{IN} \times I_{IN}$
R_{thJC}	Thermal resistance, junction to case	—	2.0	$^\circ C/W$	
T_J	Junction temperature	—	-40-125	$^\circ C$	
T_S	Storage temperature	—	-40-125		
T_f	Internal frame temperature in operation	—	-20-125		Refer to recommended operating temperature
T_{OP}	Ambient operating temperature	—	-20-125		
T_L	Lead temp. (soldering, 10 seconds)	—	300		

Recommended Operating Conditions

Time for input of quasi resonant signals.

For the Quasi resonant signal inputted to the $V_{DCP/FB}$ terminal at the time of quasi resonant operation, the signal should be wider than $T_{th}(2)$

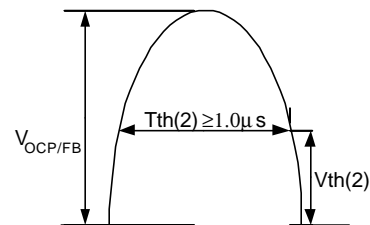

Electrical Characteristics (for Control IC)

V_{CC} = 18V, (T_A = 25°C) unless otherwise specified.

Symbol	Definition	Min.	Typ.	Max.	Units	Test Conditions
V _{CCUV+}	V _{CC} supply undervoltage positive going threshold	14.4	16	17.6	V	
V _{CCUV-}	V _{CC} supply undervoltage negative going threshold	9	10	11		
I _{QCCUV}	UVLO mode quiescent current	—	—	100	μA	V _{CC} < V _{CCUV+}
I _{QCC}	Quiescent operating V _{CC} supply current	—	—	30	mA	
T _{OFF/(MAX)}	Maximum OFF time	40	—	60	μsec	
T _{TH(2)}	Minimum input pulse width for quasi resonant signals	—	—	1.0		
T _{OFF/(MIN)}	Minimum OFF time	—	—	1.5		
V _{TH(1)}	OCP/FB terminal threshold voltage 1	0.68	0.73	0.78	V	
V _{TH(2)}	OCP/FB terminal threshold voltage 2	1.3	1.45	1.6		
I _{OCP/FB}	OCP/FB terminal sink current	1.1	1.35	1.7	mA	
V _{CC(OVP)}	V _{CC} overvoltage protection limit	20.5	22.5	24.5	V	
I _{CC(LA)}	Latch circuit holding current	—	—	400	μA	
V _{CC(LAOFF)}	Latch circuit reset voltage	6.6	—	8.4	V	
T _{J(TSD)}	Thermal shutdown activation temperature	140	—	—	°C	

Electrical Characteristics (for MOSFET)

(T_A = 25°C) unless otherwise specified.

Symbol	Definition	Min.	Typ.	Max.	Units	Test Conditions
V _{DSS}	Drain-to-source breakdown voltage	650	—	—	V	
I _{DSS}	Drain leakage current	—	—	300	μA	V _{ds} =520V, V _{CC} =0V T _J =125°C
R _{DS(ON)}	On-resistance	—	—	8.0	Ω	V ₃₋₁ =10V, I _D =0.85A
t _r	Rise time (10% to 90%)	—	—	120	ns	
TH _{J-C}	Thermal resistance	—	—	2.0	°C/W	Between junction and case

IRIS4009(K)

International
IR Rectifier

Block Diagram

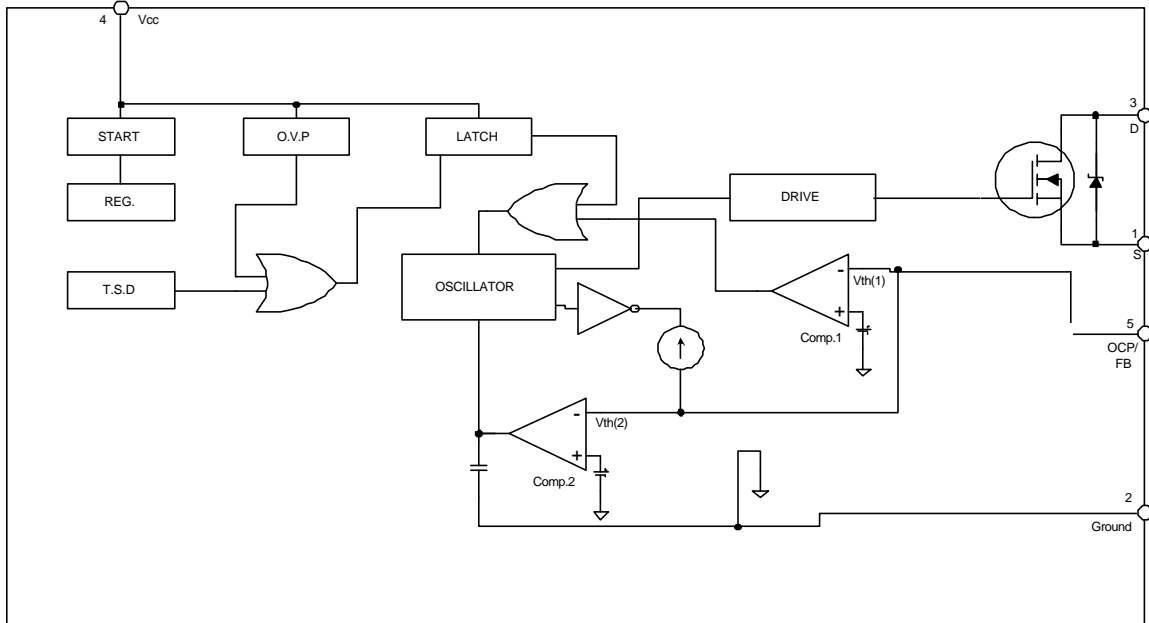

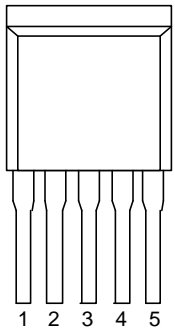
Lead Assignments	Pin #	Symbol	Description
	1	S	MOSFET Source terminal
	2	Ground	Ground terminal
	3	D	MOSFET Drain terminal
	4	Vcc	Control circuit supply voltage
	5	OCP/FB	Overcurrent detection, and Voltage mode control feedback signal

Other Functions

O.V.P. – Overvoltage Protection Circuit

T.S.D. – Thermal Shutdown Circuit

Case outline

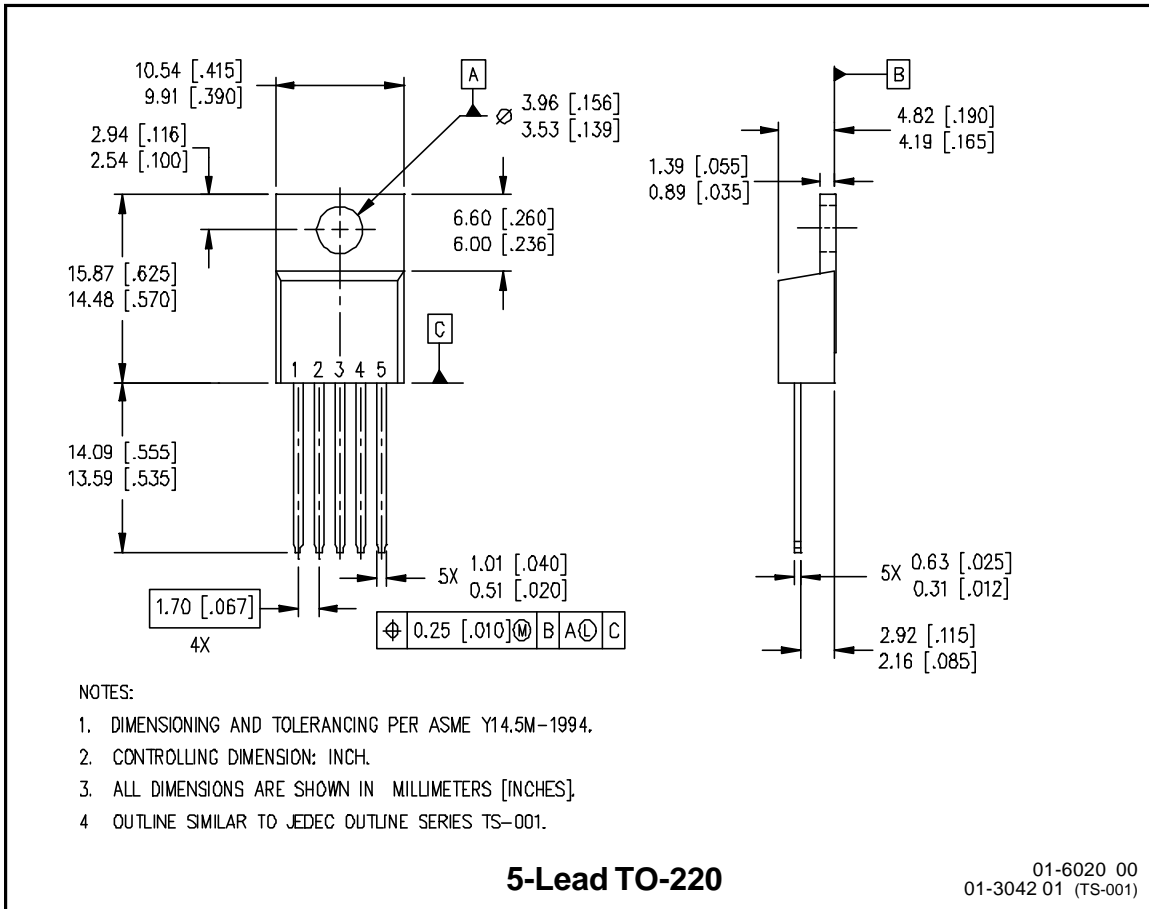

IRIS4009(K)

International
IR Rectifier

Case outline

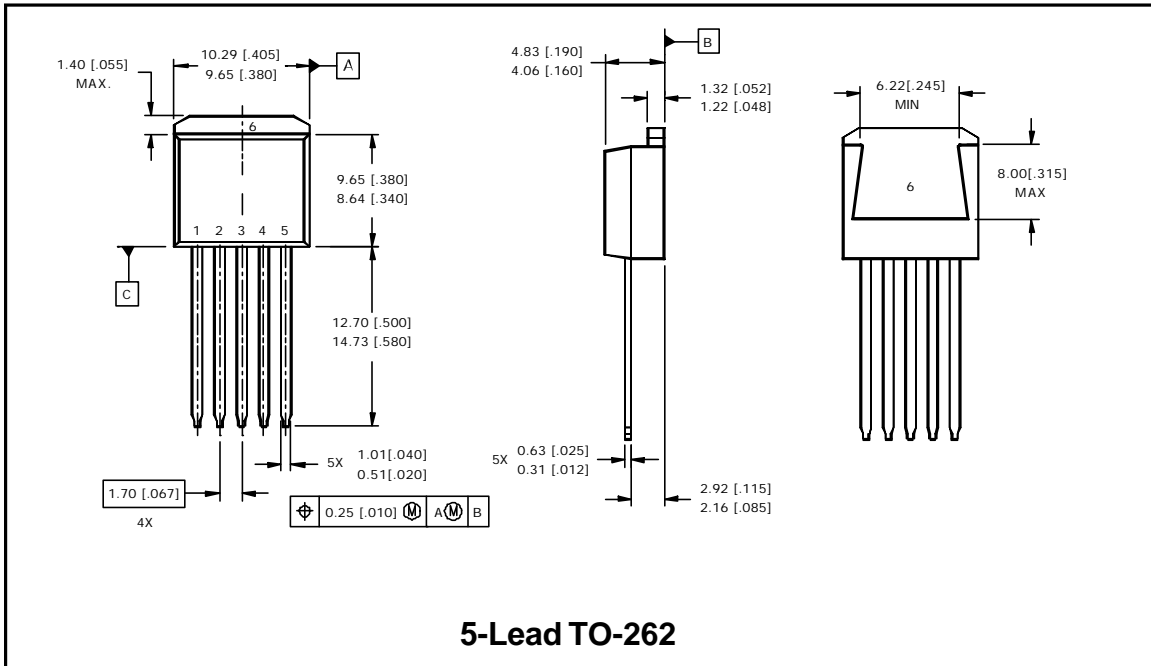

International
IR Rectifier

IR WORLD HEADQUARTERS: 233 Kansas Street, El Segundo, California 90245 Tel: (310) 252-7105
Data and specifications subject to change without notice. 12/3/2001