

Complete Sensorless Drive Design Platform iMOTION™ Development System

Features

- Low cost complete AC sensorless drive design platform
- IRMCK203 IC for complete sensorless control
- Simple design with IR2175 current sensing HVIC
- 230V/750W maximum output power with 600V/16A advanced Plug-N-Drive™ IGBT module
- Wide speed range and high speed operation
- Support any permanent magnet AC motors
- Low loss/EMI Space Vector PWM
- No voltage feedback sensing
- Low cost A/D interface with multiplexer
- 4-channel D/A output for diagnostics/monitoring
- ServoDesigner™ tool for easy operation
- RS232C/RS422 and fast SPI interface
- Parallel interface for microcontroller expansion
- Over-current and ground fault protection
- Over-voltage / Under-voltage protection
- Dynamic Braking control with brake IGBT/FWD
- Discrete I/Os (START/STOP, FAULT, FLTCLR, SYNC ESTOP, PWMEN)
- Configuration data retention at power up/down

Product Summary

Speed operation range (typical)	5 to 100%
High speed operation	100,000rpm (2pole)
Speed accuracy	0.01%
Speed resolution	15bit
PWM carrier frequency	60 kHz max
Sensorless control computation time	10 usec
Continuous output current	5 Arms (750W)
Overload output current	15 Arms (750W)
Maximum modulation index	1.2
Max RS232C speed	57.6 kbps
Optional RS422 communication	1Mbps



Description

IRMCS2031 is a complete sensorless drive design platform for industrial/appliance applications up to 1.0 HP output power. The system contains the latest advanced motion control IC, IRMCK203, and the ServoDesigner™ software. The complete B/Ms and schematics are provided so that the user can adapt and tailor the design per application needs. The system does not require any software code development due to unique Motion Control Engine implemented in the IRMCK203 IC. User can readily evaluate high performance sensorless control without spending development effort usually required in the traditional DSP or microcontroller based system. IRMCS2031 contains advanced iMOTION chipset such as IR2175 monolithic current sensing ICs and IRAMX16A60A intelligent power module, which enable simple and cost effective motion control design.



Overview

The IRMCS2031 is a design platform for a complete Sensorless drive system based on the IRMCK201 digital motion control IC. The system is based on configurable control engine implemented by hardware logics in the IRMCK203. The system has a simple and low cost structure, made possible by an advanced IR motion components including the IRAMX16UP60A IGBT module, and IR2175 monolithic current sensing high voltage IC. These components together with the IRMCK203 simplify hardware implementation. Since all control logic is implemented in hardware logic as opposed to programmed software, unmatched parallel computation is achieved resulting in higher bandwidth control and higher motor operating frequency (15 usec minimum PWM loop cycle).

Despite of hardware logic implementation, its design flexibility allows the user to configure Permanent Magnetic ac motors (Sinusoidal Back EMF) with different motor parameters and different types of communication protocols.

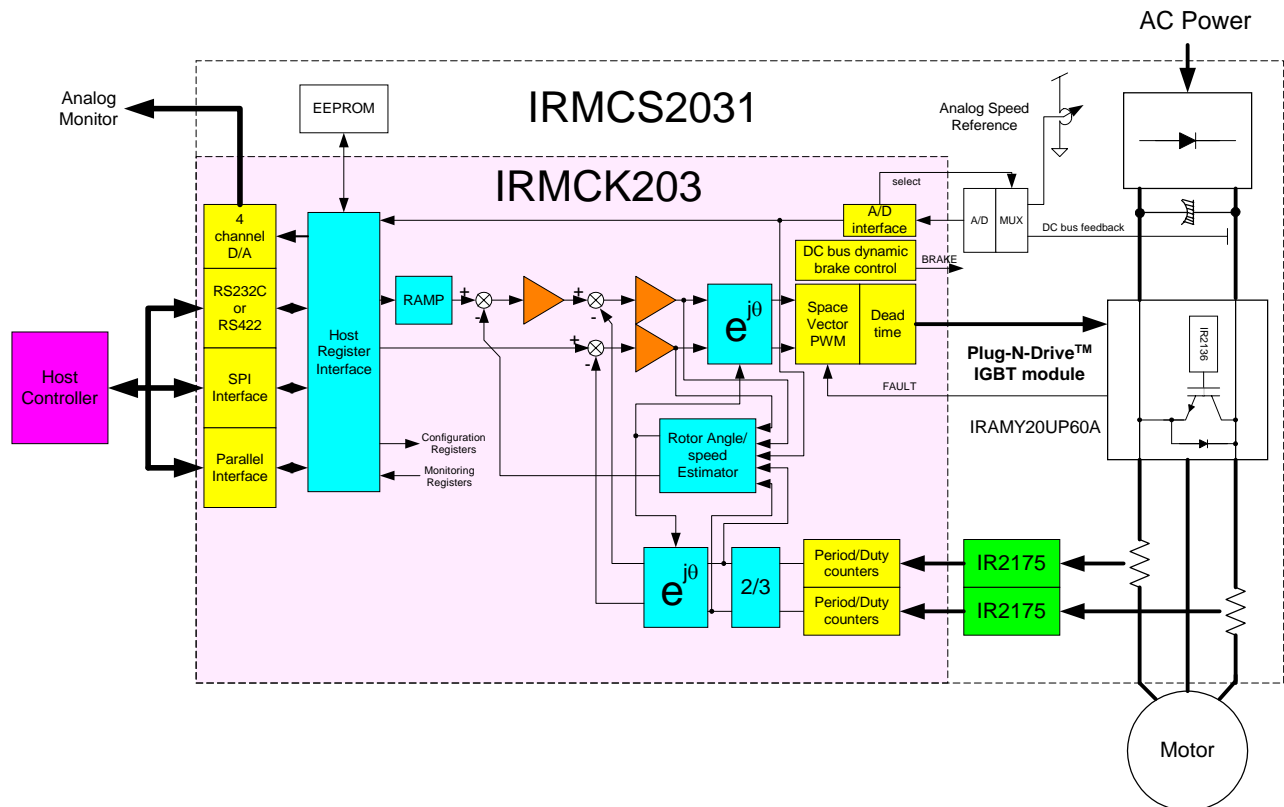

Figure 1. IRMCS2031 System Block Diagram



Safety Precautions

In addition to the precautions listed throughout this manual, you must read and understand the following statements regarding hazards associated with AC servo development system.



ATTENTION: Some ground potential of the IRMCS2031 system is biased to a negative DC bus voltage potential and kept high voltage potential while power is on. When measuring voltage waveform by oscilloscope, the scope ground needs to be isolated. Failure to do so may result in personal injury or death.
Darkened display LEDs is not an indication that capacitors have discharged to safe voltage levels.



ATTENTION: The IRMCS2031 system contains high voltage capacitors which take time to discharge after removal of main supply. Before working on drive system, ensure isolation of mains supply from line inputs [R, S, T]. Wait three minutes for capacitors to discharge to safe voltage levels. Failure to do so may result in personal injury or death.
Darkened display LEDs is not an indication that capacitors have discharged to safe voltage levels.



ATTENTION: Only personnel familiar with the drive and associated machinery should plan or implement the installation, start-up, and subsequent maintenance of the system. Failure to comply may result in personal injury and/or equipment damage.

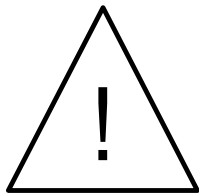

ATTENTION: The surface temperatures of the drive may become hot, which may cause injury.



ATTENTION: The IRMCS2031 system contains ESD (Electrostatic Discharge) sensitive parts and assemblies. Static control precautions are required when installing, testing, servicing or repairing this assembly. Component damage may result if ESD control



procedures are not followed. If you are not familiar with static control procedures, reference applicable ESD protection handbook and guideline.



ATTENTION: An incorrectly applied or installed drive can result in component damage or reduction in product life. Wiring or application errors such as undersizing the motor, supplying an incorrect or inadequate AC supply, or excessive ambient temperatures may result in system malfunction.



ATTENTION: Remove and lock out power from the drive before you disconnect or reconnect wires or perform service. Wait three minutes after removing power to discharge the bus voltage. Do not attempt to service the drive until bus voltage has discharged to zero. Failure to do so may result in bodily injury or death.



ATTENTION: The drive is intended to be commanded by control input that will start and stop the motor. A device that routinely disconnects then reapplies input power to the drive for the purpose of starting and stopping the motor should not be used. Failure to follow this guideline may result in damage of equipment, and/or bodily injury or death.



ATTENTION: Do not connect power factor correction capacitors to drive output terminals U, V, and W. Failure to do so may result in equipment damage or bodily injury.



Debris When Unpacking

The IRMCS2031 system is shipped with packing materials that need to be removed prior to installation.



ATTENTION: Failure to remove all debris and packing materials, which are unnecessary for system installation, may result in overheating or abnormal operating condition.



Hardware Installation

Check All Hardware

The following hardware pieces are contained in the IRMCS2031 system.

- IRMCS2031 board with integrated heat sink
- Serial RS232C cable with 9-pin Dsub connectors for ServoDesigner™ development tool
- Two 10 m Ohms shunt resistors

Step 1.

Connect motor power and ground cables to the IRMCS2031 board.

Step 2.

Connect AC115V or single phase 230V or three phase 230V power. For single phase 100V-230V AC power, use R and T for connection. For three phase 230V power, use R/S/T for connection. Insert a power contactor switch rated at 250V/30A in series with AC power cables.

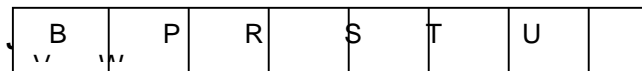

Figure 2. Power Connector, J1

Step 3.

Connect motor power lead. Follow the color code connection below.

RED = U
WHITE = V
BLACK = W

Connect Earth Ground terminal to the heatsink.

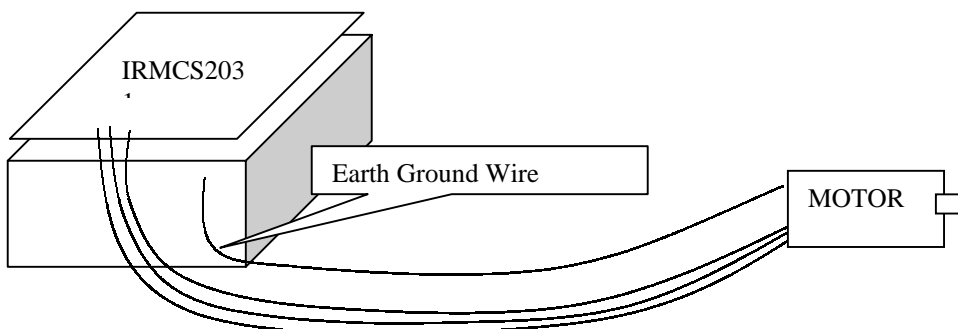

Figure 3. Earth Ground Connection

Step 5. (Optional) J7 Connector, External I/O

Connect External I/O Connector (J7) as needed. All inputs are 5V tolerant.

Pin definition

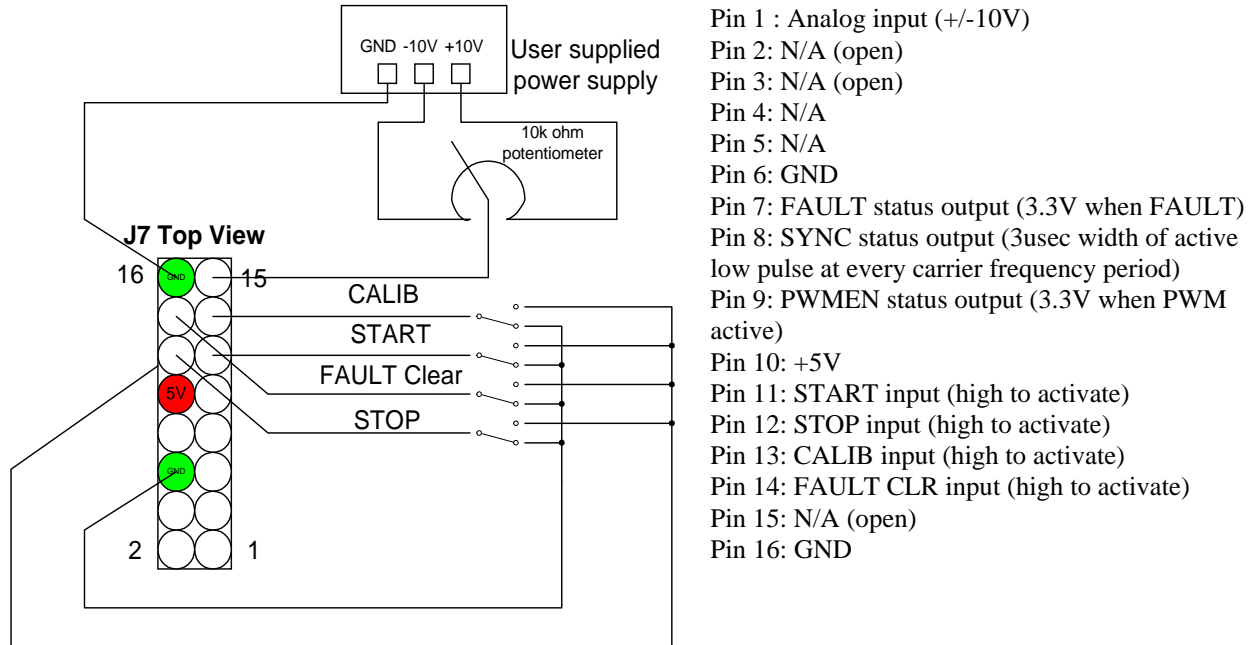
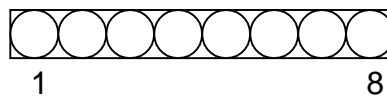

Figure 4. J7 Connector connection

Step 6. (Optional) J8 Connector, Analog Output monitoring



J8 Top View

Figure 5. J8 Connector connection

Pin Definition

- Pin 1: Channel 1 Analog output (0-5V)
- Pin 2: GND
- Pin 3: Channel 2 Analog output (0-5V)
- Pin 4: GND
- Pin 5: Channel 3 Analog output (0-5V)
- Pin 6: GND
- Pin 7: Channel 4 Analog output (0-5V)
- Pin 8: GND

Step 7.

Connect the RS232C cable between 9-pin D-sub connector and PC.



Installing the Software

The ServoDesigner™ tool is distributed on the CD-ROM. Load the CD into the CD-ROM drive on your PC and double-click “IRMCS2031.exe”. It requires the password which also can be found in the same CD-ROM. The automated procedure installs all necessary software on your PC. The default location for the installation is “C:\Program Files\Accelerator”.

Power-On the System

Apply AC115V – AC230V power to the system.

Immediately after power-on, the power supply RED LED (located at the bottom left corner of the board) will light indicating the on-board DC bus has been established. The second LED (surface mount LED located at the top side of the board) should also start blinking on/off RED.

Getting Started

For quick start with preconfigured parameters, the following motor is supported with a preconfigured motor file.

- Sanyo Denki motor (400W: type P30B06040DXS00M)

If any other motor is used, reconfiguration is required. Configurable parameters are required to tailor design to various applications (motor and load). These configurable parameters can be modified via the host register interface (using the ServoDesigner tool) through the communication interface. In the IRMCS2031 product, a design spreadsheet (Drive parameters translator) is provided to aid the user for ease of drive start-up. Using the spreadsheet, the user enters high-level parameters such as motor nameplate information, maximum application speed, current limit, speed and current regulator bandwidth. This high-level user information is translated to engineering parameters (directly used by the drive). Figure 6 gives an overview of the commissioning steps. Please refer to the IRMCK203 Application Developer’s Guide for detailed drive commissioning description.

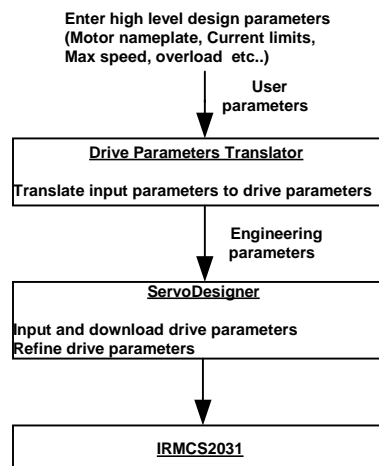

Figure 6. Overview of Drive Commissioning



Shunt Resistor and Current Rating

Two 20m Ohms current sensing shunt resistors are equipped as default resistors at factory shipment (R34 and R36 located on the bottom side of PCB). With these resistors, IRMCS2031 can deliver up to $\pm 13A$ maximum peak current to the motor including overshoot of current regulation.

When using any higher power motor with a rating greater than 3Arms and less than 6Arms continuous current, then 10m Ohm shunt resistors are recommended in place of the 20m Ohm shunt resistors.

RS232C connector

IRMCS2031 has one serial RS232C connector (J6) on the board. The connector is D-sub 9 pin standard PC female connector and directly connectable to PC serial port. As shown in Figure 8, pin2 is send signal and pin3 is receive signal, and both are 10V signal level. The baud rate is fixed at 57.6kbps. The signal format is 8bit, no parity, 1 stop bit configuration.

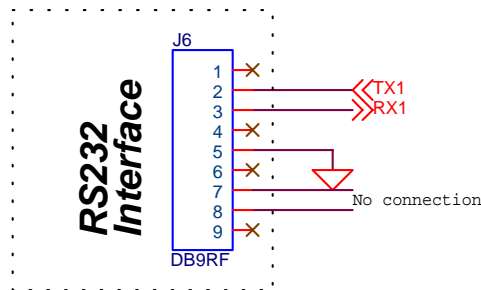

Figure 5. RS232C connector

RS-232 Register Access

The IRMCK203 includes an RS-232 interface channel that provides a direct connection to the host PC. The software interface combines a basic "register map" control interface with a simple communication protocol to accommodate potential communication errors. For more detailed information, please refer to IRMCx201 Application Development Guide.doc

RS-232 Register Write Access

A Register write operation consists of a command/address byte, byte count, register data and checksum. When the IRMCK203 receives the register data, it validates the checksum, writes the register data, and transmits and acknowledgement to the host.

Command / Address Byte	Byte Count	1-6 bytes of register data	Checksum
------------------------	------------	----------------------------	----------

Register Write Operation

Command Acknowledgement Byte	Checksum
------------------------------	----------

Register Write Acknowledgement



Bit Position							
7	6	5	4	3	2	1	0
1=Read/ 0=Write	Register Map Starting Address						

Command/Address Byte Format

Bit Position							
7	6	5	4	3	2	1	0
1=Error/ 0=OK	Register Map Starting Address						

Command Acknowledgement Byte Format

The following example shows a command sequence sent from the host to the IRMCK203 requesting a two-byte register write operation:

- 0x2F Write operation beginning at offset 0x2F
- 0x02 Byte count of register data is 2
- 0x00 Data byte 1
- 0x04 Data byte 2
- 0x35 Checksum (sum of preceding bytes, overflow discarded)

A good reply from the IRMCK203 would appear as follows:

- 0x2F Write completed OK at offset 0x2F
- 0x2F Checksum

An error reply to the command would have the following format:

- 0xAF Write at offset 0x2F completed in error
- 0xAF Checksum

RS-232 Register Read Access

A register read operation consists of a command/address byte, byte count and checksum. When the IRMCK203 receives the command, it validates the checksum and transmits the register data to the host.

Command / Address Byte	Byte Count	Checksum
------------------------	------------	----------

Register Read Operation

Command Acknowledgement Byte	Register Data (Byte Count bytes)	Checksum
------------------------------	----------------------------------	----------

Register Read Acknowledgement (transfer OK)



Register Read Acknowledgement (error)

The following example shows a command sequence sent from the host to the IRMCK203 requesting four bytes of read register data:

- 0xA0 Read operation beginning at offset 0x20 (high-order bit selects read operation)
- 0x04 Requested data byte count is 4
- 0xA4 Checksum

A good reply from the IRMCK203 might appear as follows:

- 0x20 Read completed OK at offset 0x20
- 0x11 Data byte 1
- 0x22 Data byte 2
- 0x33 Data byte 3
- 0x44 Data byte 4
- 0xCA Checksum

An error reply to the command would have the following format:

- 0xA0 Read at offset 0x20 completed in error
- 0xA0 Checksum

RS-232 Timeout

The IRMCK203 receiver includes a timer that automatically terminates transfers from the host to the IRMCK203 after a period of 32 msec.

RS-232 Transfer Examples

The following example shows a normal exchange executing a register write access.

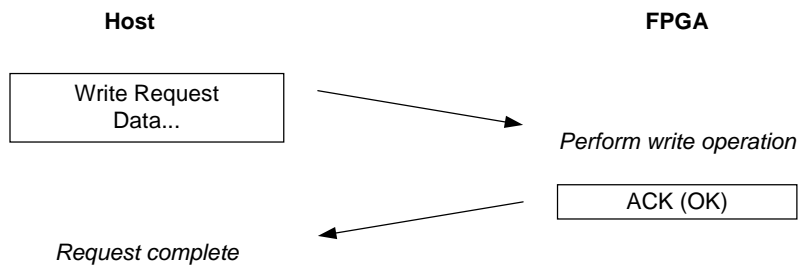

The example below shows a normal register read access exchange.



SPI interface connector

IRMCS2031 has one SPI interface connector (J4) on the board. The connector is a 6pin header and its pin assignment are shown below. The signal level is 3.3V with 5V tolerant input. Maximum transmission speed is 6MHz.

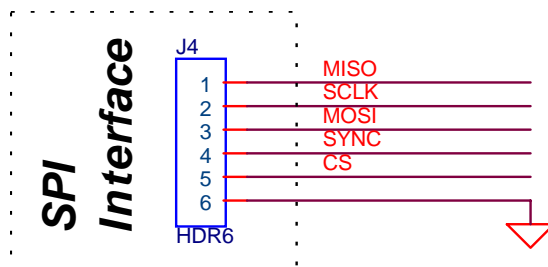
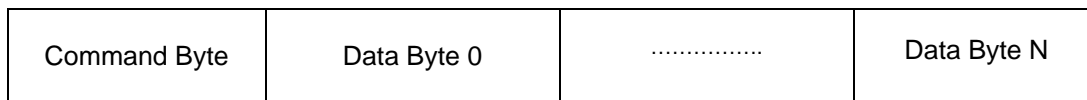

Figure 6 SPI interface connector

SPI Register Access

When configured as an SPI device read only and read/write operations are performed using the following transfer format:



Data Transfer Format

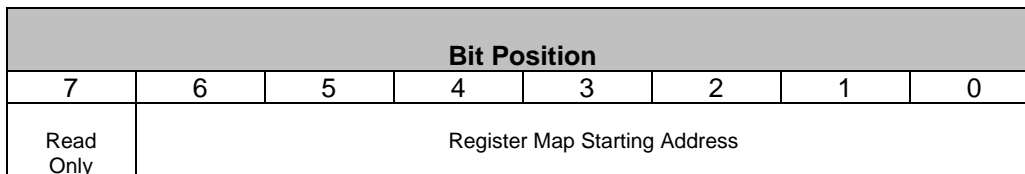

Command Byte Format

Data transfers begin at the address specified in the command byte and proceed sequentially until the SPI transfer completes. Note that accesses are read/write unless the “read only” bit is set.

Parallel Interface Port

IRMCS2031 provides a 8bit parallel interface port to facilitate microprocessor interface. Interface is generic and be able to interface most common 8bit parallel interface such as MCS8051, some Motorola 8bit uP, MicroChp,etc. Figure 9 shows the connection diagram. The connector, J5, is an 2-by-10 header connector pins.

Each signal is 3.3V level and data bus is multiplexed. Table 1 summarizes each signal definition.

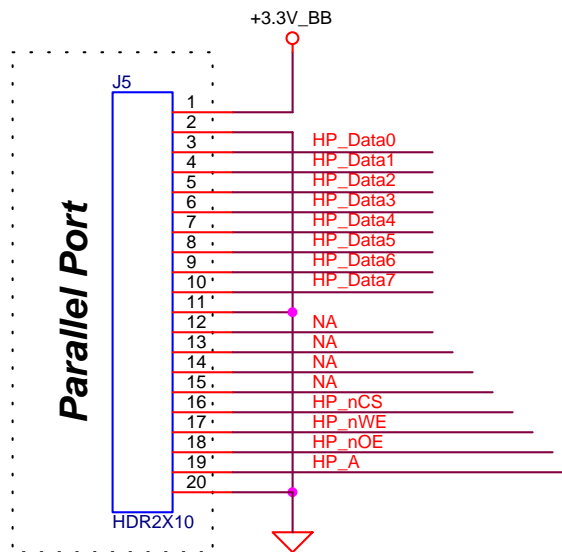

Figure 7 Parallel Interface Port

Signal	I/O ¹	Description
HP_nCS	I	Active low Host Port Chip Select
HP_nOE	I	Active Low Host Port Output Enable
HP_nWE	I	Active low Host Port Write Enable
HP_A	I	Host Port Register Address. 1 = Address register, 0 = Data Register
HP_Data	I/O	Bidirectional Host Port data bus

Table 2. Microprocessor Interface Module Signal Definitions

Figures 10 and 11 show detailed timing requirements for register read and write operations depending on the type of microprocessor (Intel or Motorola type). All values are in nanoseconds. The data bus output is activated by the logical combination (!nCS && !nOE && new), which allows read and write operations to be either nWe/nOE (Intel) or nCS (Motorola) driven. Figures 4 and 5 show example connections for Intel 8051 and Motorola 64K/Coldfire microprocessors.

Row	Name	Min	Max	Comment
1	C	TsuADDR	10	HP_A to HPnCS or HP_nWE (which ever occurs last) low setup time
2	C	TsuData	0	HP_D to HPnCS or HP_nWE (which ever occurs last) low setup time
3	C	Tpw_nCSnWE	60	Minimum pulswidth for nCS and nWE
4	C	ThData	60	Minimum data hold time from HP_nWE or HPnCS (whichever occurs last) low
5	C	ThAddr		Minimum address hold time from HP_nWE or HPnCS (whichever occurs last) low
6	D	Tacc	0 35	HP_nCS or HP_nOE (whichever occurs last) to Data access time
7	D	ThData	0 35	HP_nCS or HP_nOE (whichever occurs last) to Data invalid/Hi-

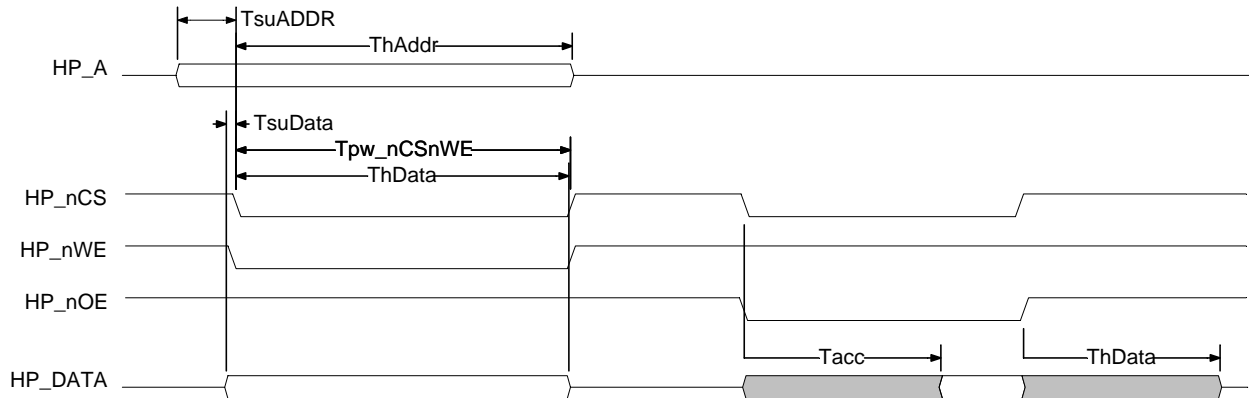

Figure 8. Register Write/Read Timing (Intel)

Row		Name	Min	Max	Comment
1	C	TsuADDR	10		HP_A to HPnCS low setup time
2	C	TsuData	0		HP_D to HPnCS low setup time
3	C	Tpw_nCSnWE	60		Minimum pulswidth for nCS
4	C	ThData	60		Minimum data hold time from HPnCS low
5	C	ThAddr			Minimum address hold time from HPnCS low
6	D	Tacc	0	35	HP_nCS to Data access time
7	D	ThData	0	35	HP_nCS to Data invalid/Hi-Z

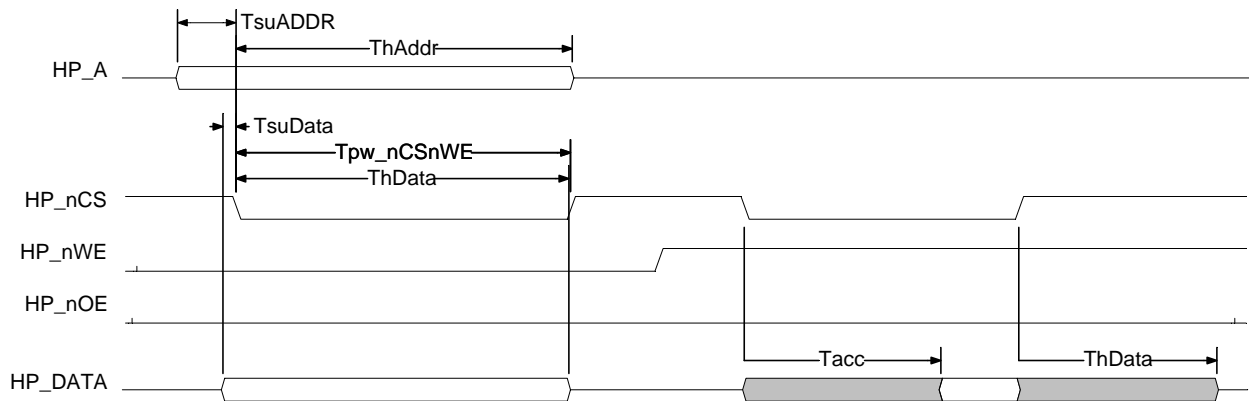

Figure 9. Register Write/Read Timing (Motorola)



Specifications

T_c=25°C unless specified

Parameters	Values	Conditions
Input Power		
Voltage	115V-230Vrms, -20%, +10%	TA=40°C,RthSA=1.0 °C/W
Frequency	50/60 Hz	
Input current	6A rms @nominal output	
Input line impedance	4%~8% recommended	
Output Power		
kW	750W continuous power	Vin=230V AC, fPWM=8kHz, fO=60Hz, TA=40°C,RthSA=1.0 °C/W ZthSA limits ΔTC to 10°C during overload
Current	5 Arms nominal, 15 Arms Overload	
Host interface (SPI)		
SCLK,CS,MISO,MOSI, SYNC	3.3V logic level	Galvanic isolated, maximum 6MHz
Host interface (RS232C)		
SND,RCV	10V	Maximum 57.6k bps, single ended, configurable for RS422 up to 1Mbps
Host interface (Parallel Port)		
HP_nCS,HP_nOE,HP_nWE, HP_A,HP_DATA[8]	3.3V	8 bit parallel interface compatible with 8051, Microchip,other uP.
D/A		
10 bit 4 Channel	0-5V output	Output are buffered with 4mA drive capability
A/D		
12 bit 2 channel	±10V for reference input, 5V for DCbus input	4 channel additional input available (optional)
Discrete I/O		
Input	4 bit, START, STOP, FLTCLR, CALIB	5V tolerant, Isolated, Active High logic
Output	3 bit, PWMACTIVE, FAULT, SYNC	
Current feedback		
Current sensing device	IR2175, direct interface	133 MHz internal IRMCK203 clock
Resolution	10 bit (7.5 nanoseconds counting resolution)	
Latency	8.3 usec	
Protection		
Output current trip level	27.5A peak, ±10%	Fixed by IRAM16XUP60A module
Ground fault trip level	35A peak, ±10%	
Over-temperature trip level	110°C, ±5%	Case temperature line-to-line short, line-to-DC bus (-) short
Short circuit delay time	2.5 usec	
DC bus voltage		
Maximum DC bus voltage	400V	Should not exceed 400V for > 30 sec VCC=15V ± 10%,VDD=5V ± 5%
Minimum DC bus voltage	85V	
Power Module		
IRAMX16UP60A 3-phase HVIC	6 IGBT/FRED + IR2136 gate driver, integrated overcurrent/overtemp protection	Bootstrap power supply for high side circuit
System environment		
Ambient temperature	0 to 40°C	95%RH max. (non-condensing)

Table 1. IRMCS2031 Electrical Specification



IRMCS2031

International
IOR Rectifier

IR WORLD HEADQUARTERS: 233 Kansas St., El Segundo, California 90245, Tel: (310) 252-7105
<http://www.irf.com> *Data and specifications subject to change without notice*
January 6, 2004

Sales Offices, Agents and Distributors in Major Cities Throughout the World.