



查询ITC117P供应商

CLARE

MICRO CHIPS.  
MACRO SOLUTIONS.

捷多邦，专业PCB打样工厂，24小时加急出货

# ITC117P Integrated Telecom Circuits



	ITC117P	Units
Relay Load Voltage	350	V
Relay Load Current	120	mA
Relay Max R <sub>ON</sub>	15	Ω
Bridge Rectifier Reverse Voltage	100	V
Darlington Collector Current	120	mA
Darlington Current Gain	10,000	-

## Features

- Small 16 Pin SOIC Package (PCMCIA Compatible)
- Board Space and Cost Savings
- 2mW Hookswitch Drive Power (Logic Compatible)
- No Moving Parts
- 3750V<sub>RMS</sub> Input/Output Isolation
- FCC Compatible Part 68
- Full-Wave Bridge Rectifier
- Darlington Transistor for Electronic Inductor "Dry" Circuits
- Full Wave Current Detector for Ring Signal or Loop Current Detect
- JEDEC Standard Pin Out

## Applications

- Data/Fax Modem
- Voice Mail Systems
- Telephone Sets
- Computer Telephony Integration
- Set Top Box Modems

## Description

The Integrated Telecom Circuit combines a 1-Form-A solid state relay, bridge rectifier, Darlington transistor and opto-coupler into one 16 pin SOIC package, consolidating designs and reducing component count in telecom applications. The ITC117's optocoupler provides for full wave detection of ring signals.

## Approvals

- UL Recognized: File Number E76270
- CSA Certified: File Number LR 43639-12
- BSI Certified:
  - BS EN 60950:1992 (BS7002:1992) Certificate #: 7969
  - BS EN 41003:1993 Certificate #: 7969

## Ordering Information

Part #	Description
ITC117P	16 Pin SOIC (50/Tube)
ITC117P	16 Pin SOIC (1000/Reel)

## Pin Configuration

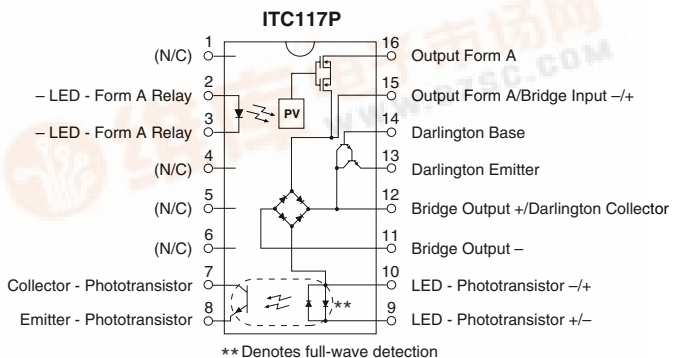



## ITC117P

## Absolute Maximum Ratings (@ 25° C)

Parameter	Min	Typ	Max	Units
Total Package Dissipation	-	-	1 <sup>1</sup>	W
Isolation Voltage				
Input to Output	3750	-	-	V <sub>RMS</sub>
Operational Temperature	-40	-	+85	°C
Storage Temperature	-40	-	+125	°C
Soldering Temperature (10 Seconds Max.)	-	-	+220	°C

<sup>1</sup> Above 25° derate linearly 8.33mw/°C

Total Power Dissipation (PD):

$$P_D = P_{\text{HOOKSWITCH}} + P_{\text{BRIDGE}} + P_{\text{DARLINGTON}} + P_{\text{LED}}$$

$$P_D = (R_{\text{DS(on)}})(I_L^2) + 2(V_F)(I_L) + (V_{\text{CE}})(I_L) + (V_{\text{LED}})(I_F)$$

WHERE:

$R_{\text{DS(on)}}$  = Maximum relay on resistance

$I_L$  = Maximum loop current

$V_F$  = Maximum diode forward voltage

$V_{\text{CE}}$  = Maximum voltage collector to emitter

$V_{\text{LED}}$  = Maximum LED forward voltage

$I_F$  = Maximum LED current

*Absolute Maximum Ratings are stress ratings. Stresses in excess of these ratings can cause permanent damage to the device. Functional operation of the device at these or any other conditions beyond those indicated in the operational sections of this data sheet is not implied. Exposure of the device to the absolute maximum ratings for an extended period may degrade the device and effect its reliability.*

## Electrical Characteristics

Parameter	Conditions	Symbol	Min	Typ	Max	Units
<b>Relay Portion (Pins 15,16)</b>						
<b>Output Characteristics @ 25°C</b>						
Load Voltage, DC or Peak AC	-	$V_L$	-	-	350	V
Load Current (Continuous)	-	$I_L$	-	-	120	mA
On-Resistance	$I_L=120\text{mA}$	$R_{\text{ON}}$	-	-	15	$\Omega$
Off-State Leakage Current	$V_L=350, T_J=25^\circ\text{C}$	$I_{\text{LEAK}}$	-	-	1	$\mu\text{A}$
Switching Speeds						
Turn-On	$I_F=5\text{mA}, V_L=10\text{V}$	$T_{\text{ON}}$	-	-	3	ms
Turn-Off	$I_F=5\text{mA}, V_L=10\text{V}$	$T_{\text{OFF}}$	-	-	3	ms
Output Capacitance	50V, f=1MHz	$C_{\text{OUT}}$	-	25	-	pF
<b>Relay Portion (Pins 2,3)</b>						
<b>Input Characteristics @ 25°C</b>						
Input Control Current	$I_L=120\text{mA}$	$I_F$	5	-	50	mA
Input Voltage Drop	$I_F=5\text{mA}$	$V_F$	0.9	1.2	1.4	V
Reverse Input Voltage	-	$V_R$	-	-	5	V
Reverse Input Current	$V_R=5\text{V}$	$I_R$	-	-	10	$\mu\text{A}$
<b>Detector Portion (Pins 7,8)</b>						
<b>Output Characteristics @ 25°C</b>						
Phototransistor Blocking Voltage	$I_C=10\mu\text{A}$	$BV_{\text{CEO}}$	20	50	-	V
Phototransistor Dark Current	$V_{\text{CE}}=5\text{V}, I_F=0\text{mA}$	$I_{\text{CEO}}$	-	50	500	A
Saturation Voltage	$I_C=2\text{mA}, I_F=16\text{mA}$	$V_{\text{SAT}}$	-	0.3	0.5	V
Current Transfer Ratio	$I_F=6\text{mA}, V_{\text{CE}}=0.5\text{V}$	CTR	33	400	-	%
<b>Detector Portion (Pins 9,10)</b>						
<b>Input Characteristics @ 25°C</b>						
Input Control Current	$I_C=2\text{mA}, V_{\text{CE}}=0.5\text{V}$	$I_F$	6	2	100	mA
Input Voltage Drop	$I_F=5\text{mA}$	$V_F$	0.9	1.2	1.4	V
Input Current (Detector must be off)	$I_C=1\mu\text{A}, V_{\text{CE}}=5\text{V}$	$I_F$	5	25	-	$\mu\text{A}$

**Electrical Characteristics**

Parameter	Conditions	Symbol	Min	Typ	Max	Units
<b>Bridge Rectifier Electrical Ratings @ 25°C</b>						
Reverse Voltage	-	$V_{RD}$	-	-	100	V
Forward Drop Voltage	$I_{FD}=120\text{mA}$	$V_{FD}$	-	-	1.5	V
Reverse Leakage Current	$T_J=25^\circ\text{C}, V_R=100\text{V}$ $T_J=85^\circ\text{C}$	$I_{RD}$	-	-	10 50	$\mu\text{A}$ $\mu\text{A}$
Forward Current (Continuous)		$I_{FD}$	-	-	140	mA
Forward Current (Peak)	$t=10\text{mS}$	$I_{FD}$	-	-	0.5	A
<b>Darlington Electrical Ratings @ 25°C</b>						
Collector-Emitter Voltage	$I_C=10\text{mA DC}, I_B=0$	$V_{CEO}$	40	-	-	V
Collector-Current Continuous	$V_C=3.5\text{V}$	$I_C$	-	-	120	mA
Power Dissipation @ 25°C	-	$P_d$	-	-	500	mW
Off-State Collector Emitter Leakage Current	$V_{CE}=10\text{V}; I_B=0\text{mA}$	$I_{CEX}$	-	-	1	$\mu\text{A}$
DC Current Gain	$I_C=120\text{mA},$ $V_{CE}=10\text{VDC}$	$h_{FE}$	10,000	-	-	
Saturation Voltage	$I_C=120\text{mA}$	$V_{CE(SAT)}$	-	-	1.5	V
Total Harmonic Distortion	$f_o=300\text{Hz @ } -10\text{dBm}$ $I_C=40\text{mA}$	-	-	-	-80	dB
<b>Zener Characteristics @ 25°C</b>						
Zener Voltage (Between pins 4+5 and 6+5)	$I_{Z1}=20\text{mA}$	$V_z$	-	-	-	V
Zener Voltage (Between pins 12+11)	$I_{Z1}=20\text{mA}$	$V_z$	-	-	-	V
Input to Output Capacitance	-	$C_{I/O}$	-	3	-	pF
Input to Output Isolation	-	$V_{I/O}$	3750	-	-	$V_{RMS}$

## PERFORMANCE DATA\*

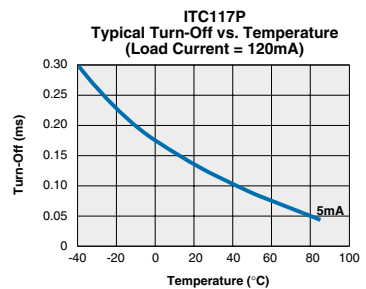
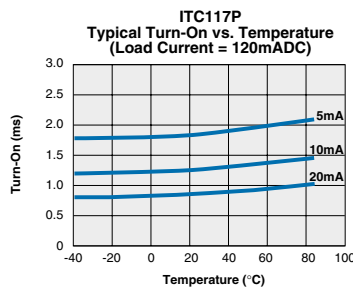
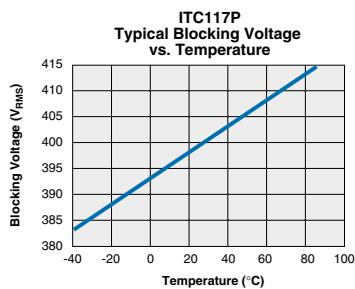
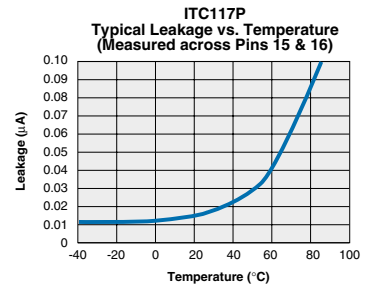
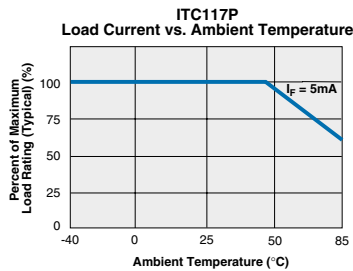
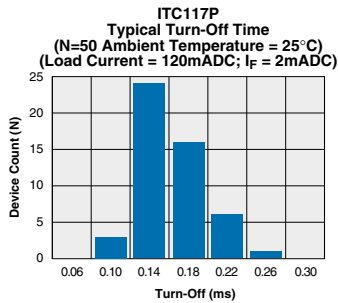
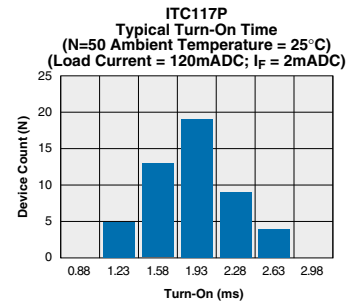
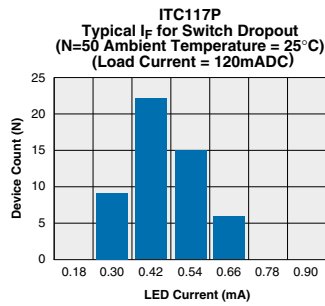
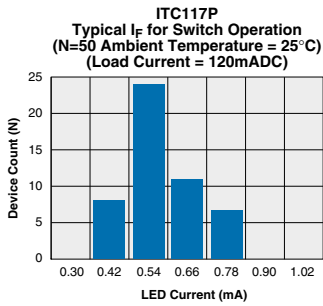
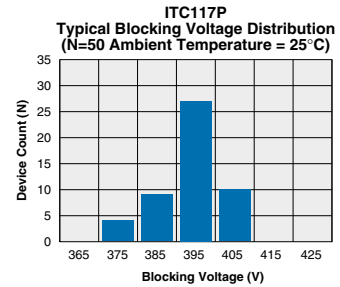
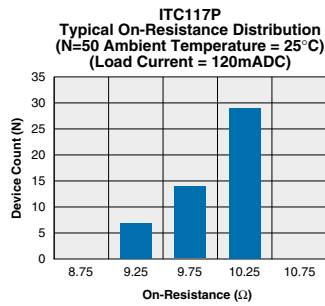
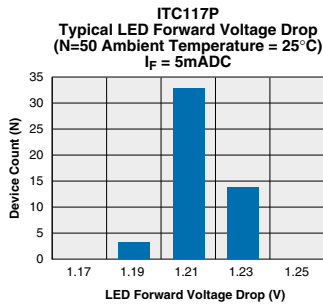

The Performance data shown in the graphs above is typical of device performance. For guaranteed parameters not indicated in the written specifications, please contact our application department.

## PERFORMANCE DATA\*

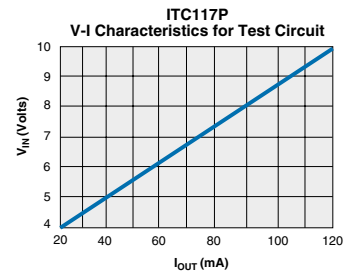
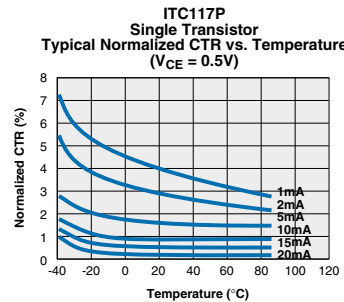
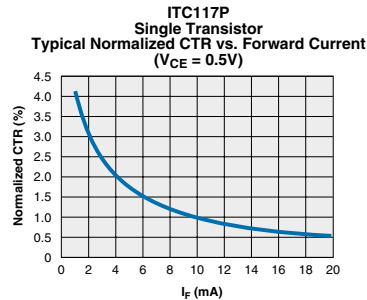
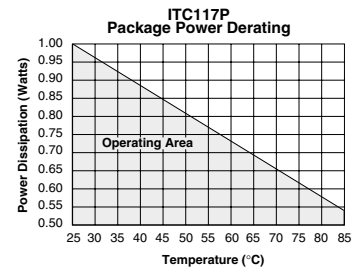
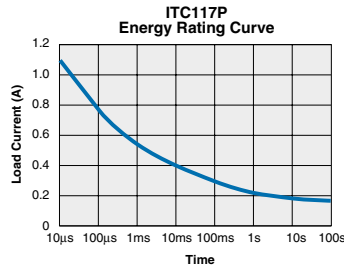
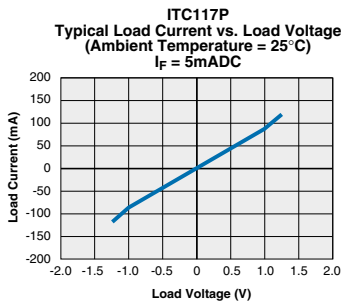
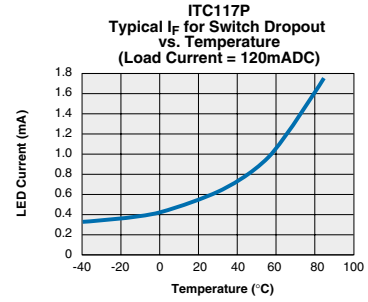
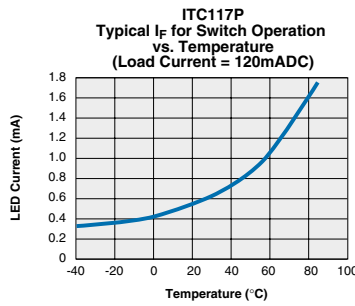
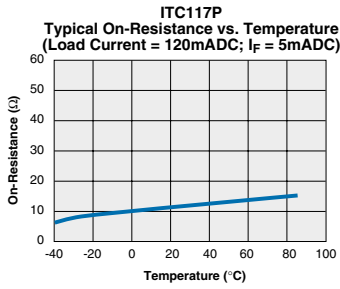
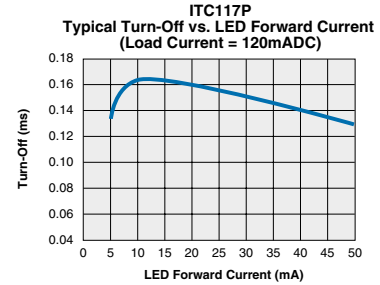
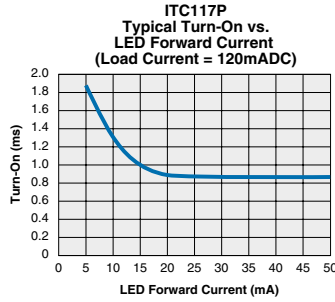
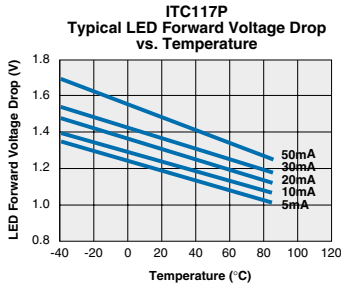

\*The Performance data shown in the graphs above is typical of device performance. For guaranteed parameters not indicated in the written specifications, please contact our application department.

PERFORMANCE DATA\*

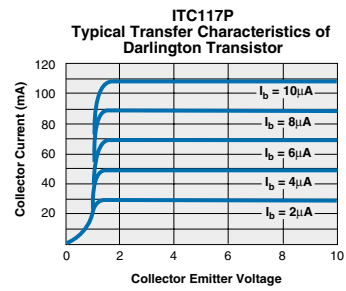
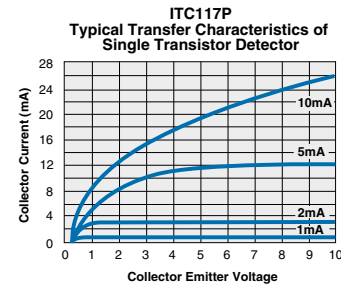
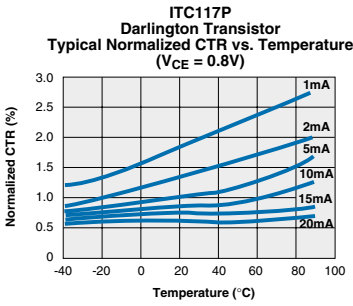
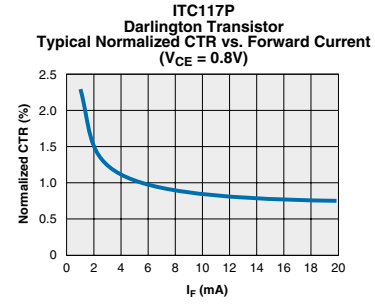
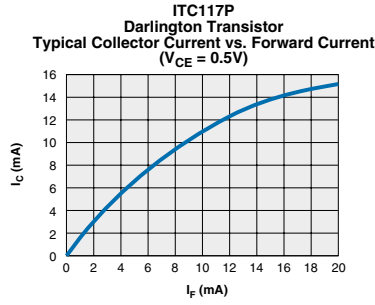
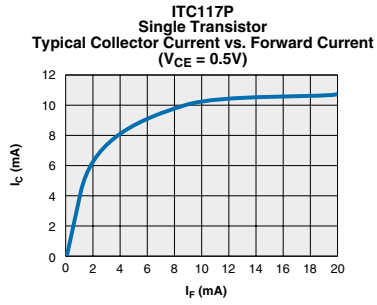

\*The Performance data shown in the graphs above is typical of device performance. For guaranteed parameters not indicated in the written specifications, please contact our application department.

Mechanical Dimensions

16 Pin SOIC ("P" Suffix)

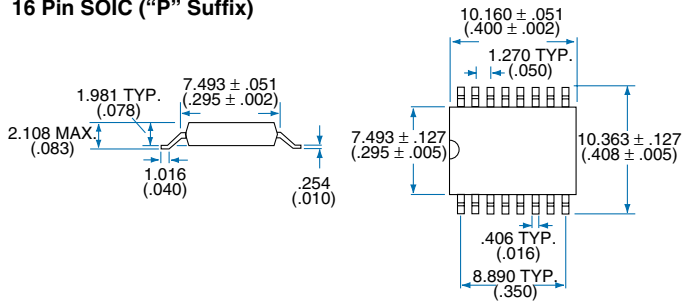

PC Board Pattern (Top View)

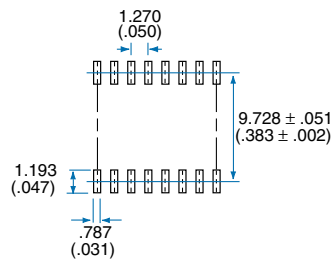

Tape and Reel Packaging for 16 Pin SOIC Package

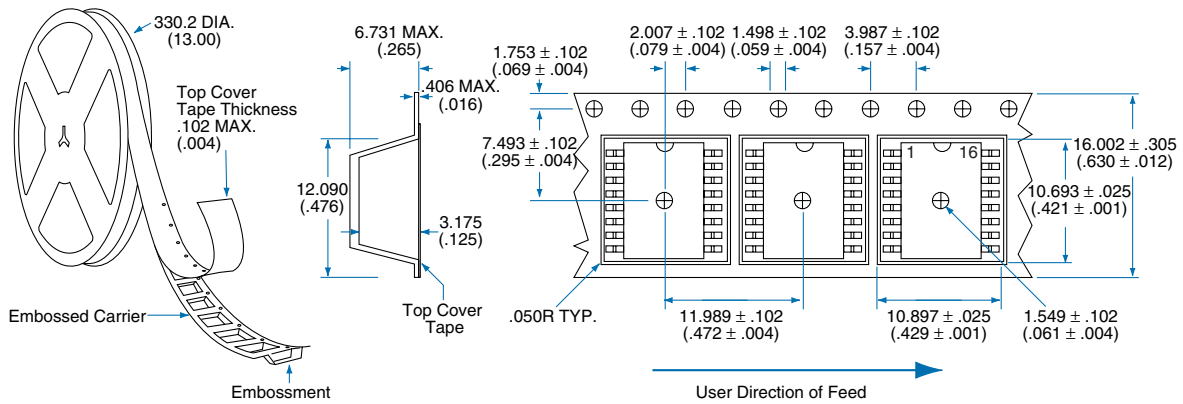



## Worldwide Sales Offices

### CLARE LOCATIONS

Clare Headquarters  
78 Cherry Hill Drive  
Beverly, MA 01915  
Tel: 1-978-524-6700  
Fax: 1-978-524-4900  
Toll Free: 1-800-27-CLARE

Clare Micronix Division  
145 Columbia  
Aliso Viejo, CA 92656-1490  
Tel: 1-949-831-4622  
Fax: 1-949-831-4628

### SALES OFFICES

#### AMERICAS

##### Americas Headquarters

Clare  
78 Cherry Hill Drive  
Beverly, MA 01915  
Tel: 1-978-524-6700  
Fax: 1-978-524-4900  
Toll Free: 1-800-27-CLARE

##### Eastern Region

Clare  
P.O. Box 856  
Mahwah, NJ 07430  
Tel: 1-201-236-0101  
Fax: 1-201-236-8685  
Toll Free: 1-800-27-CLARE

##### Central Region

Clare Canada Ltd.  
3425 Harvester Road, Suite 202  
Burlington, Ontario L7N 3N1  
Tel: 1-905-333-9066  
Fax: 1-905-333-1824

##### Western Region

Clare  
1852 West 11th Street, #348  
Tracy, CA 95376  
Tel: 1-209-832-4367  
Fax: 1-209-832-4732  
Toll Free: 1-800-27-CLARE

##### Canada

Clare Canada Ltd.  
3425 Harvester Road, Suite 202  
Burlington, Ontario L7N 3N1  
Tel: 1-905-333-9066  
Fax: 1-905-333-1824

### EUROPE

#### European Headquarters

CP Clare nv  
Bampslaan 17  
B-3500 Hasselt (Belgium)  
Tel: 32-11-300868  
Fax: 32-11-300890

#### France

Clare France Sales  
Lead Rep  
99 route de Versailles  
91160 Champlan  
France  
Tel: 33 1 69 79 93 50  
Fax: 33 1 69 79 93 59

#### Germany

Clare Germany Sales  
ActiveComp Electronic GmbH  
Mitterstrasse 12  
85077 Manching  
Germany  
Tel: 49 8459 3214 10  
Fax: 49 8459 3214 29

#### Italy

C.L.A.R.E.s.a.s.  
Via C. Colombo 10/A  
I-20066 Melzo (Milano)  
Tel: 39-02-95737160  
Fax: 39-02-95738829

#### Sweden

Clare Sales  
Comptronic AB  
Box 167  
S-16329 Spånga  
Tel: 46-862-10370  
Fax: 46-862-10371

#### United Kingdom

Clare UK Sales  
Marco Polo House  
Cook Way  
Bindon Road  
Taunton  
UK-Somerset TA2 6BG  
Tel: 44-1-823 352541  
Fax: 44-1-823 352797

### ASIA/PACIFIC

#### Asian Headquarters

Clare  
Room N1016, Chia-Hsin, Bldg II,  
10F, No. 96, Sec. 2  
Chung Shan North Road  
Taipei, Taiwan R.O.C.  
Tel: 886-2-2523-6368  
Fax: 886-2-2523-6369

<http://www.clare.com>

*Clare cannot assume responsibility for use of any circuitry other than circuitry entirely embodied in this Clare product. No circuit patent licenses nor indemnity are expressed or implied. Clare reserves the right to change the specification and circuitry, without notice at any time. The products described in this document are not intended for use in medical implantation or other direct life support applications where malfunction may result in direct physical harm, injury or death to a person.*