

MJE18004D2

POWER TRANSISTORS
5 AMPERES
1000 VOLTS
75 WATTS

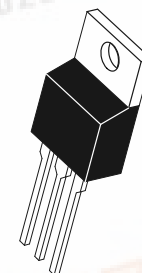
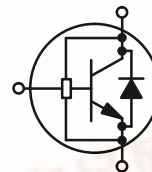

CASE 221A-06
TO-220AB

Designer's™ Data Sheet

High Speed, High Gain Bipolar NPN Power Transistor with Integrated Collector-Emitter Diode and Built-in Efficient Antisaturation Network

The MJE18004D2 is state-of-art High Speed High gain BIPolar transistor (H2BIP). High dynamic characteristics and lot to lot minimum spread (± 150 ns on storage time) make it ideally suitable for light ballast applications. Therefore, there is no need to guarantee an h_{FE} window.

Main features:

- Low Base Drive Requirement
- High Peak DC Current Gain (55 Typical) @ $I_C = 100$ mA
- **Extremely Low Storage Time Min/Max Guarantees Due to the H2BIP Structure which Minimizes the Spread**
- Integrated Collector-Emitter Free Wheeling Diode
- Fully Characterized and Guaranteed Dynamic $V_{CE(sat)}$
- "6 Sigma" Process Providing Tight and Reproducible Parameter Spreads

It's characteristics make it also suitable for PFC application.

MAXIMUM RATINGS

Rating	Symbol	Value	Unit
Collector-Emitter Sustaining Voltage	V_{CEO}	450	Vdc
Collector-Base Breakdown Voltage	V_{CB0}	1000	Vdc
Collector-Emitter Breakdown Voltage	V_{CES}	1000	Vdc
Emitter-Base Voltage	V_{EBO}	12	Vdc
Collector Current — Continuous	I_C	5	Adc
— Peak (1)	I_{CM}	10	
Base Current — Continuous	I_B	2	Adc
— Peak (1)	I_{BM}	4	
*Total Device Dissipation @ $T_C = 25^\circ\text{C}$	P_D	75	Watt
*Derate above 25°C		0.6	W/ $^\circ\text{C}$
Operating and Storage Temperature	T_J, T_{stg}	-65 to 150	$^\circ\text{C}$

THERMAL CHARACTERISTICS

Thermal Resistance — Junction to Case	$R_{\theta JC}$	1.65	$^\circ\text{C/W}$
— Junction to Ambient	$R_{\theta JA}$	62.5	
Maximum Lead Temperature for Soldering Purposes: 1/8" from case for 5 seconds	T_L	260	$^\circ\text{C}$

(1) Pulse Test: Pulse Width = 5 ms, Duty Cycle $\leq 10\%$.

Designer's Data for "Worst Case" Conditions — The Designer's Data Sheet permits the design of most circuits entirely from the information presented. SOA Limit curves — Representing boundaries on device characteristics — are given to facilitate "worst case" design.

Designer's and SWITCHMODE are trademarks of Motorola, Inc.



MOTOROLA

MJE18004D2

ELECTRICAL CHARACTERISTICS (T_C = 25°C unless otherwise noted)

Characteristic	Symbol	Min	Typ	Max	Unit
OFF CHARACTERISTICS					
Collector–Emitter Sustaining Voltage (I _C = 100 mA, L = 25 mH)	V _{CEO(sus)}	450	547		Vdc
Collector–Base Breakdown Voltage (I _{CBO} = 1 mA)	V _{CB0}	1000	1100		Vdc
Emitter–Base Breakdown Voltage (I _{EBO} = 1 mA)	V _{EBO}	12	14		Vdc
Collector Cutoff Current (V _{CE} = Rated V _{CEO} , I _B = 0)	I _{CEO}			100	μAdc
Collector Cutoff Current (V _{CE} = Rated V _{CES} , V _{EB} = 0) (V _{CE} = 500 V, V _{EB} = 0)	I _{CES}	@ T _C = 25°C @ T _C = 125°C @ T _C = 125°C		100 500 100	μAdc
Emitter–Cutoff Current (V _{EB} = 10 Vdc, I _C = 0)	I _{EBO}			100	μAdc

ON CHARACTERISTICS

Base–Emitter Saturation Voltage (I _C = 0.8 Adc, I _B = 80 mAdc) (I _C = 2 Adc, I _B = 0.4 Adc)	@ T _C = 25°C @ T _C = 125°C @ T _C = 25°C @ T _C = 125°C	V _{BE(sat)}		0.8 0.7 0.9 0.8	1 0.9 1 0.9	Vdc
Collector–Emitter Saturation Voltage (I _C = 0.8 Adc, I _B = 80 mAdc) (I _C = 2 Adc, I _B = 0.4 Adc) (I _C = 0.8 Adc, I _B = 40 mAdc) (I _C = 1 Adc, I _B = 0.2 Adc)	@ T _C = 25°C @ T _C = 125°C @ T _C = 25°C @ T _C = 125°C @ T _C = 25°C @ T _C = 125°C @ T _C = 25°C @ T _C = 125°C	V _{CE(sat)}		0.38 0.55 0.45 0.75 0.9 1.6 0.25 0.28	0.5 0.75 0.75 1 1.5 0.5 0.6	Vdc
DC Current Gain (I _C = 0.8 Adc, V _{CE} = 1 Vdc) (I _C = 2 Adc, V _{CE} = 1 Vdc) (I _C = 1 Adc, V _{CE} = 2.5 Vdc)	@ T _C = 25°C @ T _C = 125°C @ T _C = 25°C @ T _C = 125°C @ T _C = 25°C @ T _C = 125°C	h _{FE}	15 10 6 4 18 14	28 14 8 6 28 20		—

DYNAMIC SATURATION VOLTAGE

Dynamic Saturation Voltage: Determined 1 μs and 3 μs respectively after rising I _{B1} reaches 90% of final I _{B1}	I _C = 1 Adc I _{B1} = 100 mA V _{CC} = 300 V	@ 1 μs	@ T _C = 25°C @ T _C = 125°C	V _{CE(dsat)}		9 16		V
		@ 3 μs	@ T _C = 25°C @ T _C = 125°C			3.1 9		
	I _C = 2 Adc I _{B1} = 0.4 A V _{CC} = 300 V	@ 1 μs	@ T _C = 25°C @ T _C = 125°C			11 18		
		@ 3 μs	@ T _C = 25°C @ T _C = 125°C			1.4 8		

ELECTRICAL CHARACTERISTICS ($T_C = 25^\circ\text{C}$ unless otherwise noted)

Characteristic	Symbol	Min	Typ	Max	Unit
----------------	--------	-----	-----	-----	------

DIODE CHARACTERISTICS

Forward Diode Voltage ($I_{EC} = 1 \text{ Adc}$)	@ $T_C = 25^\circ\text{C}$ @ $T_C = 125^\circ\text{C}$	V_{EC}		0.96 0.72	1.5	V	
	($I_{EC} = 2 \text{ Adc}$)		@ $T_C = 25^\circ\text{C}$ @ $T_C = 125^\circ\text{C}$		1.15 0.8		1.7
Forward Recovery Time ($I_F = 0.4 \text{ Adc}$, $di/dt = 10 \text{ A}/\mu\text{s}$)	@ $T_C = 25^\circ\text{C}$	t_{fr}		440		ns	
	($I_F = 1 \text{ Adc}$, $di/dt = 10 \text{ A}/\mu\text{s}$)		@ $T_C = 25^\circ\text{C}$		335		
	($I_F = 2 \text{ Adc}$, $di/dt = 10 \text{ A}/\mu\text{s}$)		@ $T_C = 25^\circ\text{C}$		335		

DYNAMIC CHARACTERISTICS

Current Gain Bandwidth ($I_C = 0.5 \text{ Adc}$, $V_{CE} = 10 \text{ Vdc}$, $f = 1 \text{ MHz}$)	f_T		13		MHz
Output Capacitance ($V_{CB} = 10 \text{ Vdc}$, $I_E = 0$, $f = 1 \text{ MHz}$)	C_{ob}		60	100	pF
Input Capacitance ($I_C = 0.5 \text{ Adc}$, $V_{CE} = 10 \text{ Vdc}$, $f = 1 \text{ MHz}$)	C_{ib}		450	750	pF

SWITCHING CHARACTERISTICS: Resistive Load ($D.C. \leq 10\%$, Pulse Width = 40 μs)

Turn-on Time	$I_C = 2.5 \text{ Adc}$, $I_{B1} = 0.5 \text{ Adc}$ $I_{B2} = 1 \text{ Adc}$ $V_{CC} = 250 \text{ Vdc}$	@ $T_C = 25^\circ\text{C}$	t_{on}		500	750	ns
Turn-off Time		@ $T_C = 25^\circ\text{C}$	t_{off}	1.1		1.4	μs
Turn-on Time	$I_C = 2 \text{ Adc}$, $I_{B1} = 0.4 \text{ Adc}$ $I_{B2} = 1 \text{ Adc}$ $V_{CC} = 300 \text{ Vdc}$	@ $T_C = 25^\circ\text{C}$ @ $T_C = 125^\circ\text{C}$	t_{on}		100 150	150	ns
Turn-off Time		@ $T_C = 25^\circ\text{C}$ @ $T_C = 125^\circ\text{C}$	t_{off}		1.15 1.6	1.3	μs
Turn-on Time	$I_C = 2.5 \text{ Adc}$, $I_{B1} = 0.5 \text{ Adc}$ $I_{B2} = 0.5 \text{ Adc}$ $V_{CC} = 300 \text{ Vdc}$	@ $T_C = 25^\circ\text{C}$ @ $T_C = 125^\circ\text{C}$	t_{on}		120 500	150	ns
Turn-off Time		@ $T_C = 25^\circ\text{C}$ @ $T_C = 125^\circ\text{C}$	t_{off}	1.85		2.6	2.15 μs

SWITCHING CHARACTERISTICS: Inductive Load ($V_{CC} = 15 \text{ V}$)

Fall Time	$I_C = 2.5 \text{ Adc}$ $I_{B1} = 500 \text{ mAdc}$ $I_{B2} = 500 \text{ mAdc}$ $V_Z = 350 \text{ V}$ $L_C = 300 \mu\text{H}$	@ $T_C = 25^\circ\text{C}$ @ $T_C = 125^\circ\text{C}$	t_f		130 300	175	ns
Storage Time		@ $T_C = 25^\circ\text{C}$ @ $T_C = 125^\circ\text{C}$	t_s		2.12 2.6	2.4	μs
Crossover Time		@ $T_C = 25^\circ\text{C}$ @ $T_C = 125^\circ\text{C}$	t_c		355 750	500	ns
Fall Time	$I_C = 2 \text{ Adc}$ $I_{B1} = 400 \text{ mAdc}$ $I_{B2} = 400 \text{ mAdc}$ $V_Z = 300 \text{ V}$ $L_C = 200 \mu\text{H}$	@ $T_C = 25^\circ\text{C}$ @ $T_C = 125^\circ\text{C}$	t_f		95 230	150	ns
Storage Time		@ $T_C = 25^\circ\text{C}$ @ $T_C = 125^\circ\text{C}$	t_s	2.1		2.9	2.4 μs
Crossover Time		@ $T_C = 25^\circ\text{C}$ @ $T_C = 125^\circ\text{C}$	t_c		300 700	450	ns
Fall Time	$I_C = 1 \text{ Adc}$ $I_{B1} = 100 \text{ mAdc}$ $I_{B2} = 500 \text{ mAdc}$ $V_Z = 300 \text{ V}$ $L_C = 200 \mu\text{H}$	@ $T_C = 25^\circ\text{C}$ @ $T_C = 125^\circ\text{C}$	t_f		70 100	90	ns
Storage Time		@ $T_C = 25^\circ\text{C}$ @ $T_C = 125^\circ\text{C}$	t_s		0.7 1.05	0.9	μs
Crossover Time		@ $T_C = 25^\circ\text{C}$ @ $T_C = 125^\circ\text{C}$	t_c		75 160	120	ns

TYPICAL STATIC CHARACTERISTICS

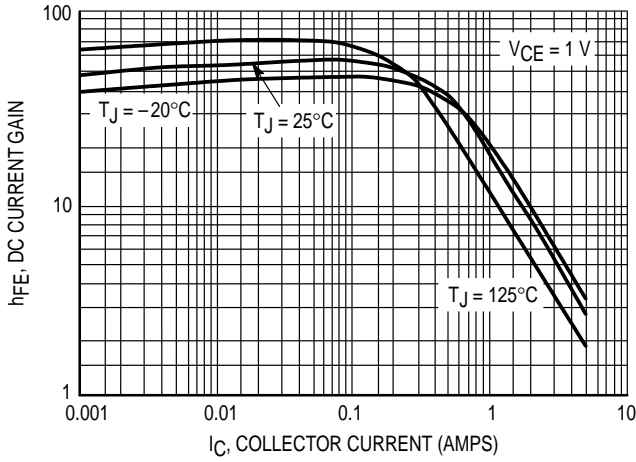

Figure 1. DC Current Gain @ 1 Volt

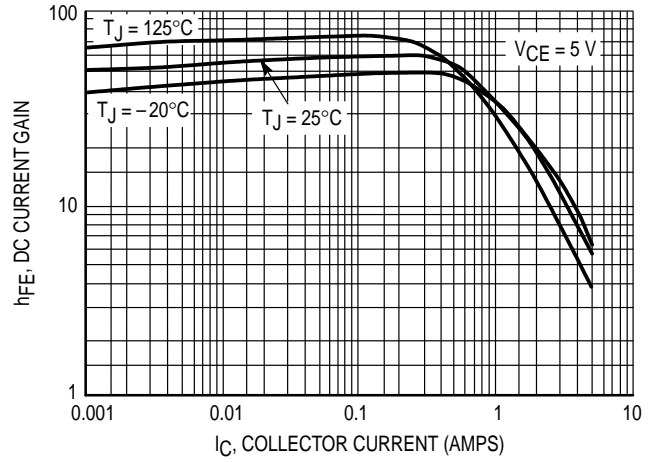

Figure 2. DC Current Gain @ 5 Volt

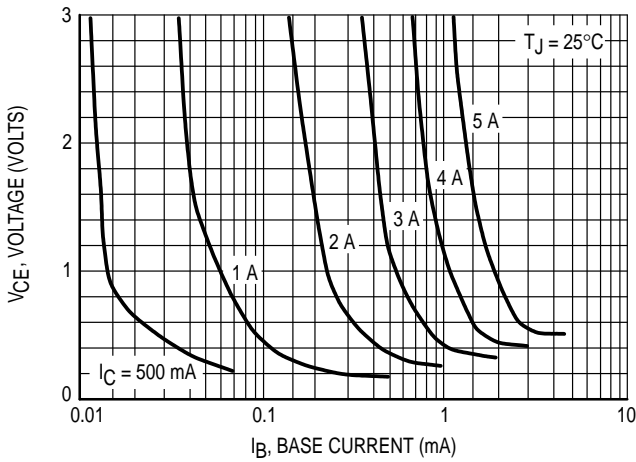

Figure 3. Collector Saturation Region

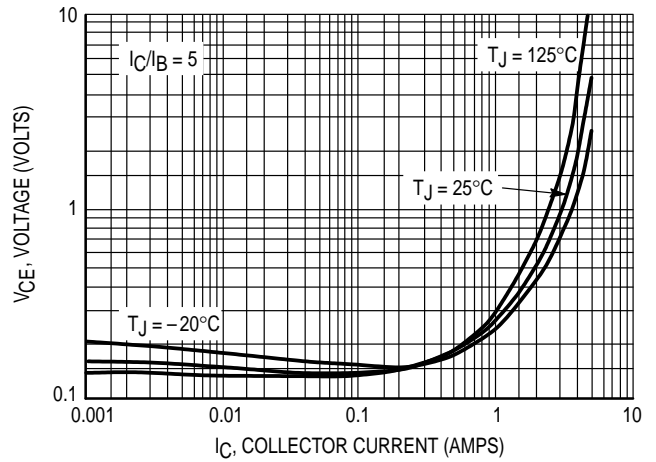

Figure 4. Collector-Emitter Saturation Voltage

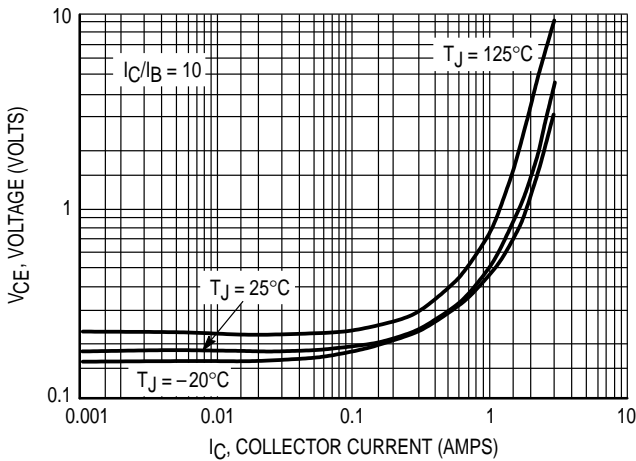

Figure 5. Collector-Emitter Saturation Voltage

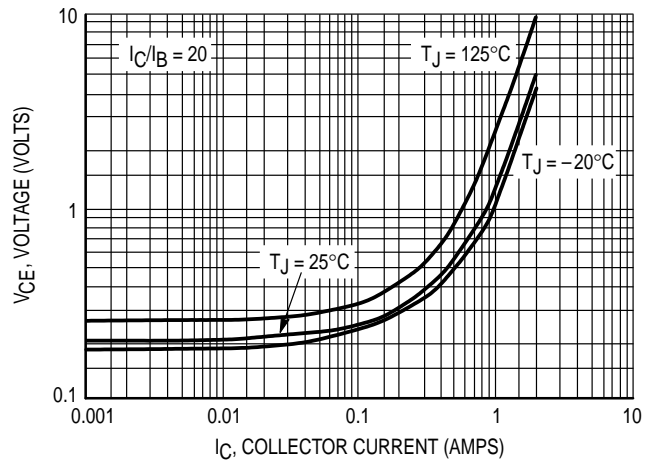

Figure 6. Collector-Emitter Saturation Voltage

TYPICAL STATIC CHARACTERISTICS

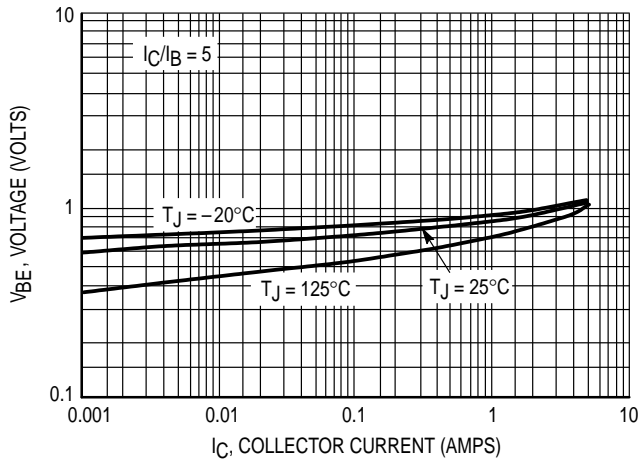

Figure 7. Base-Emitter Saturation Region

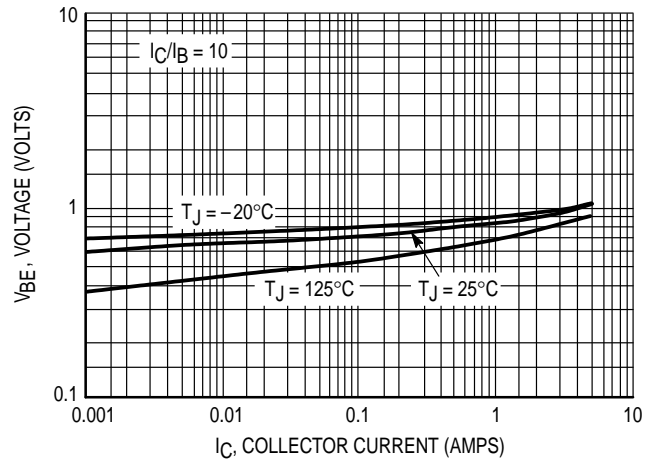

Figure 8. Base-Emitter Saturation Region

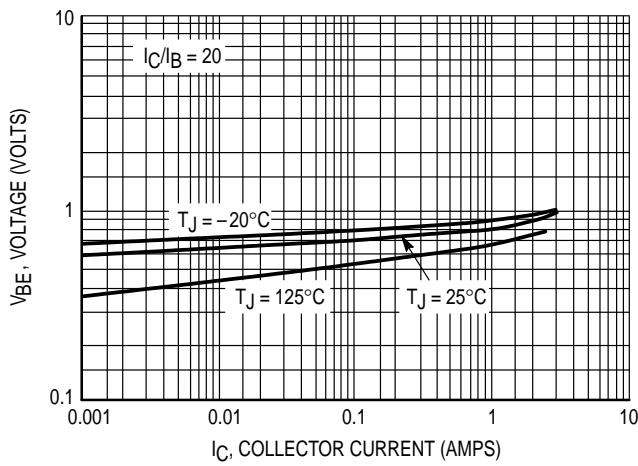

Figure 9. Base-Emitter Saturation Region

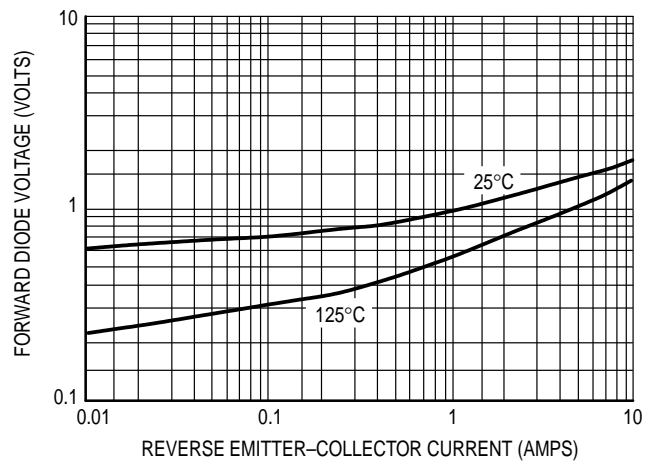

Figure 10. Forward Diode Voltage

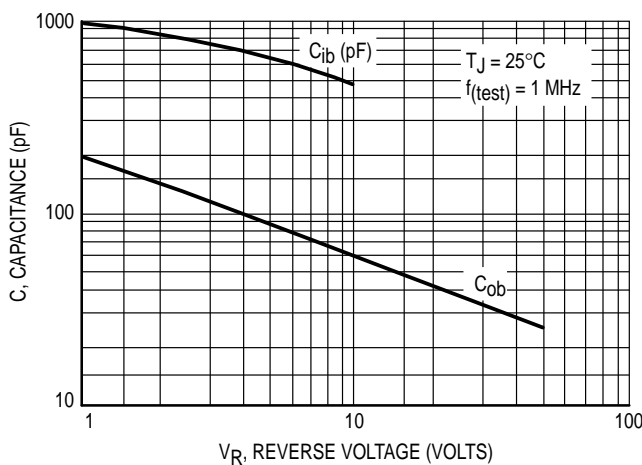

Figure 11. Capacitance

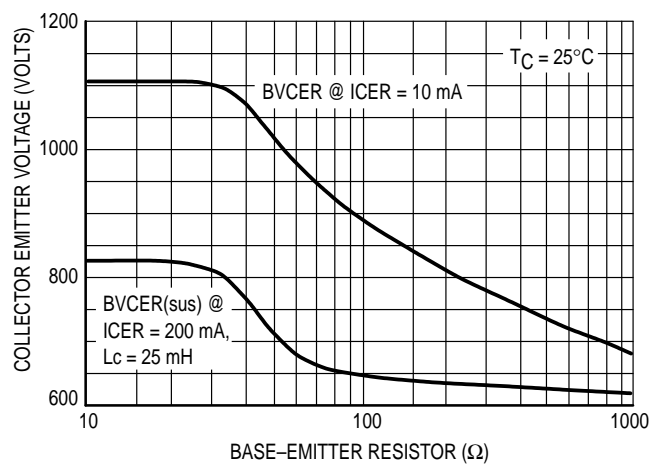

Figure 12. BVCER = f(RBE)

TYPICAL SWITCHING CHARACTERISTICS

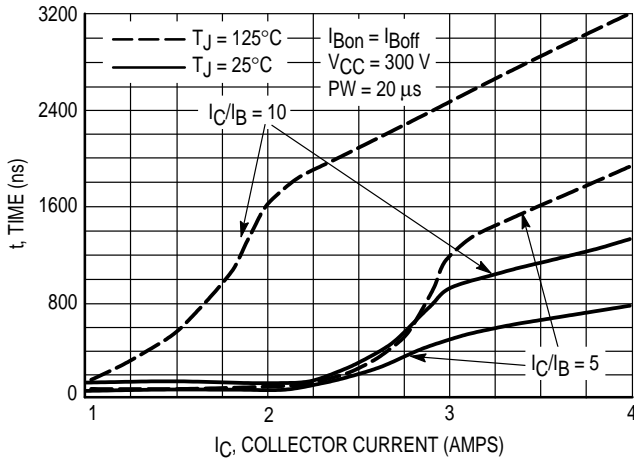

Figure 13. Resistive Switch Time, t_{on}

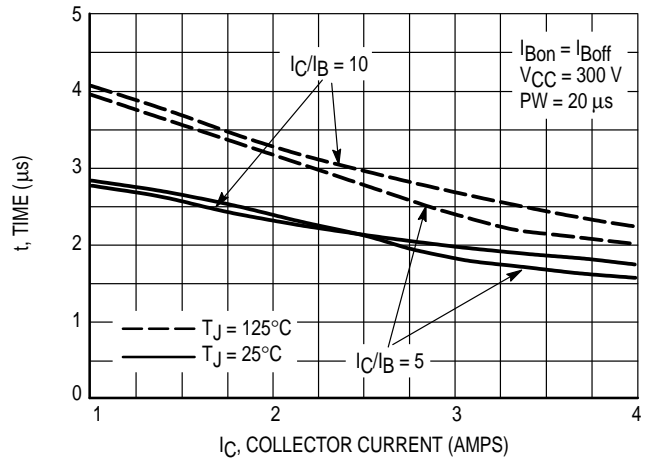

Figure 14. Resistive Switch Time, t_{off}

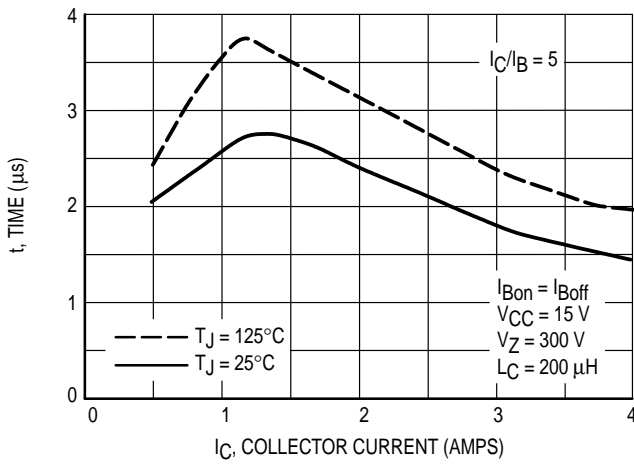

Figure 15. Inductive Storage Time, t_{si} @ $I_C/I_B = 5$

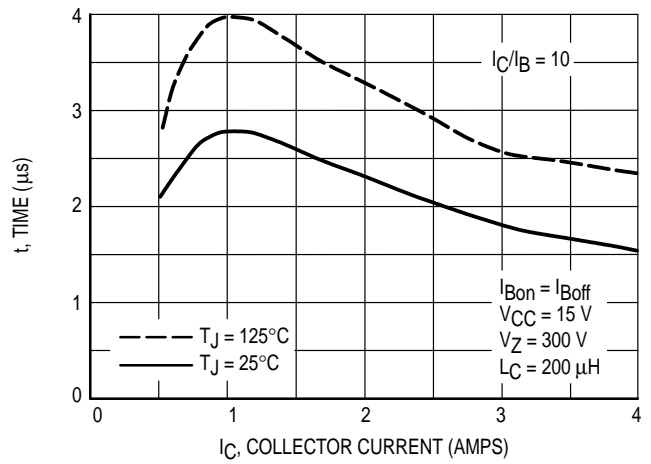

Figure 16. Inductive Storage Time, t_{si} @ $I_C/I_B = 10$

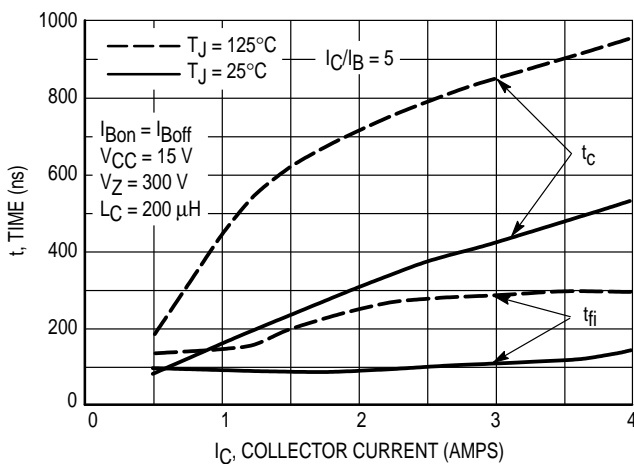

Figure 17. Inductive Switching Time, t_c & t_{fi} @ $I_C/I_B = 5$

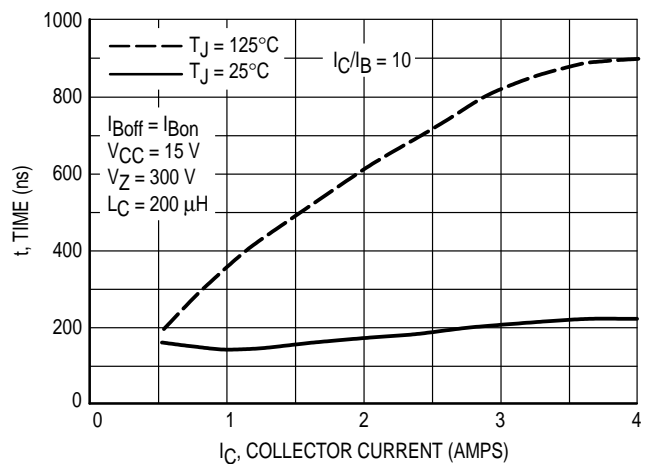

Figure 18. Inductive Switching Time, t_{fi} @ $I_C/I_B = 10$

TYPICAL SWITCHING CHARACTERISTICS

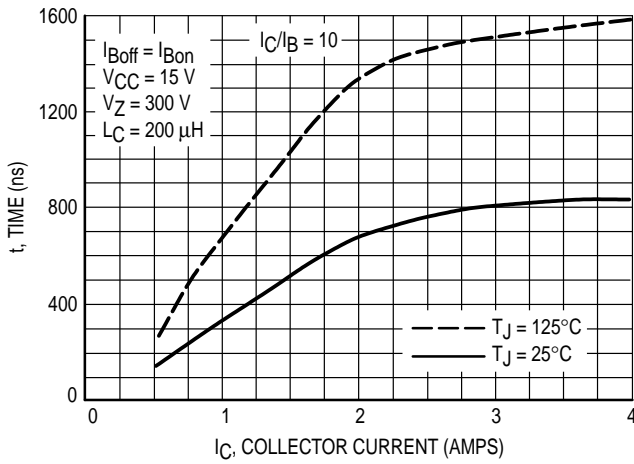

Figure 19. Inductive Switching, t_c @ $I_C/I_B = 10$

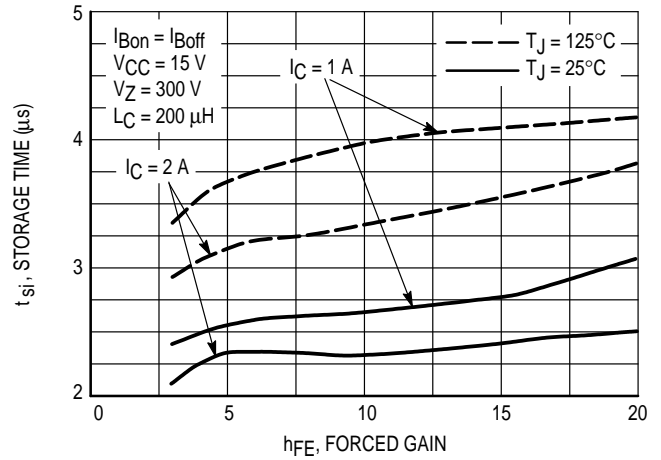

Figure 20. Inductive Storage Time

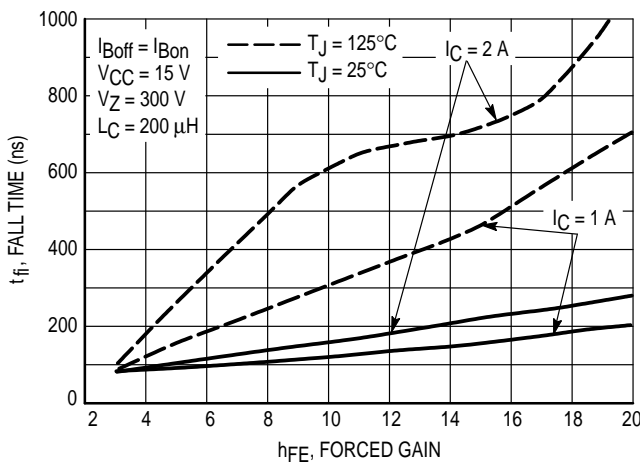

Figure 21. Inductive Fall Time

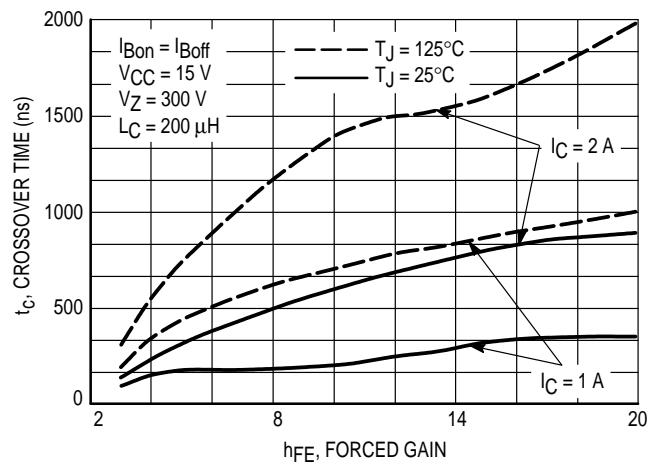

Figure 22. Inductive Crossover Time

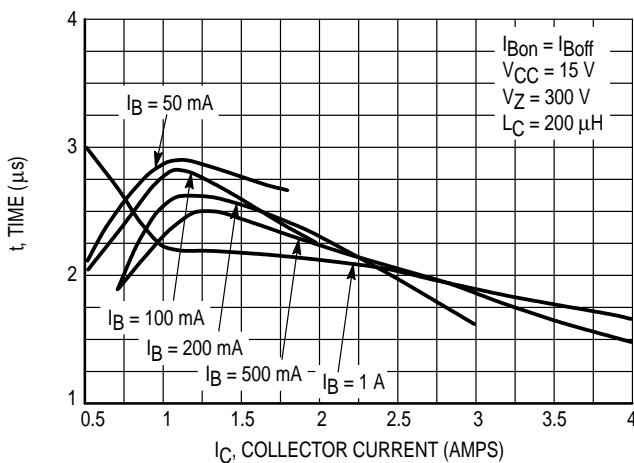

Figure 23. Inductive Storage Time, t_{si}

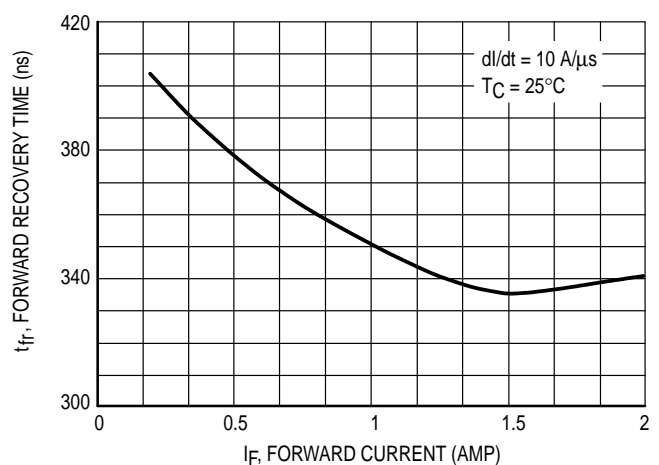

Figure 24. Forward Recovery Time, T_{FR}

MJE18004D2

TYPICAL SWITCHING CHARACTERISTICS

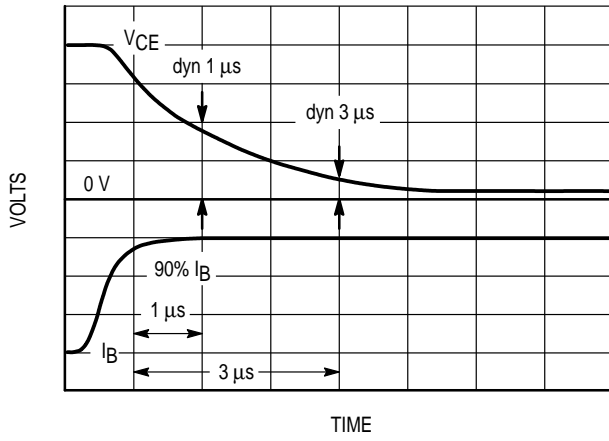

Figure 25. Dynamic Saturation Voltage Measurements

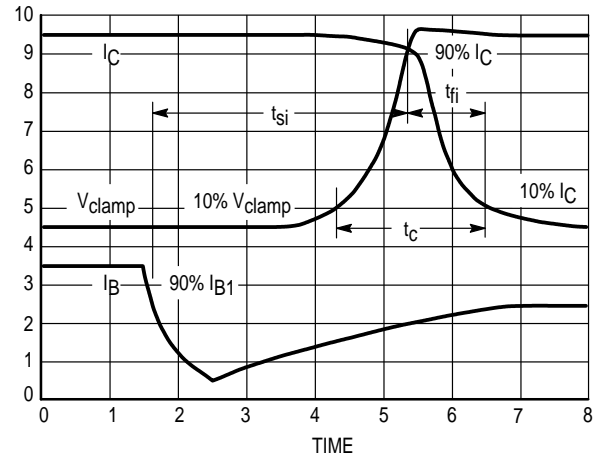

Figure 26. Inductive Switching Measurements

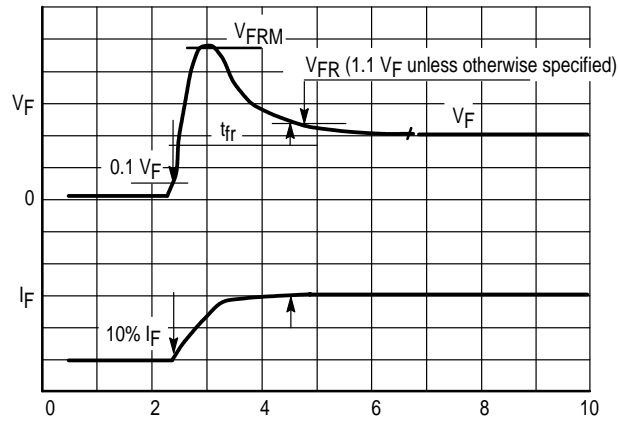
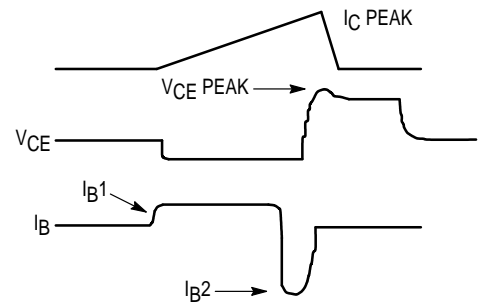
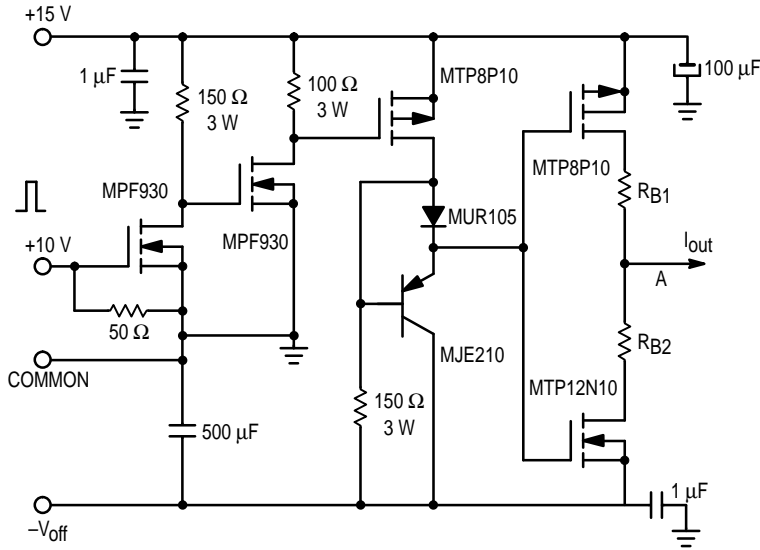

Figure 27. t_{fr} Measurements

TYPICAL SWITCHING CHARACTERISTICS

Table 1. Inductive Load Switching Drive Circuit



$V_{(BR)CEO(sus)}$	Inductive Switching	RBSOA
$L = 10 \text{ mH}$	$L = 200 \mu\text{H}$	$L = 500 \mu\text{H}$
$RB2 = \infty$	$RB2 = 0$	$RB2 = 0$
$V_{CC} = 20 \text{ Volts}$	$V_{CC} = 15 \text{ Volts}$	$V_{CC} = 15 \text{ Volts}$
$I_{C(pk)} = 100 \text{ mA}$	$RB1$ selected for desired I_{B1}	$RB1$ selected for desired I_{B1}

TYPICAL CHARACTERISTICS

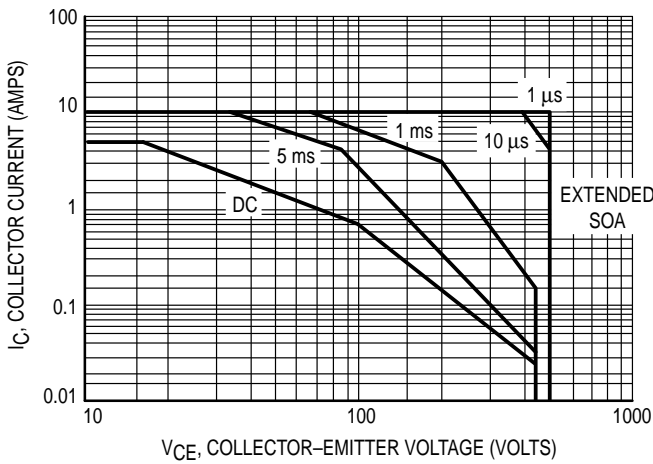

Figure 28. Forward Bias Safe Operating Area

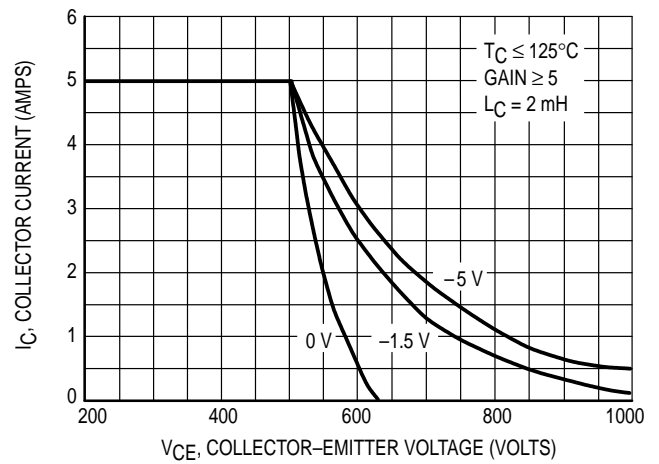

Figure 29. Reverse Bias Safe Operating Area

TYPICAL CHARACTERISTICS

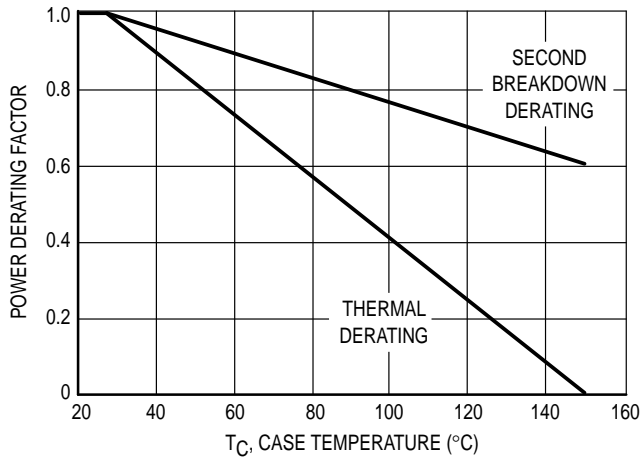

Figure 30. Forward Bias Power Derating

There are two limitations on the power handling ability of a transistor: average junction temperature and second breakdown. Safe operating area curves indicate I_C-V_{CE} limits of the transistor that must be observed for reliable operation; i.e., the transistor must not be subjected to greater dissipation than the curves indicate. The data of Figure 28 is based on $T_C = 25^\circ\text{C}$; $T_J(pk)$ is variable depending on power level. Second breakdown pulse limits are valid for duty cycles to 10% but must be derated when $T_C > 25^\circ\text{C}$. Second breakdown limitations do not derate the same as thermal limitations. Allowable current at the voltages shown on Figure 28 may be found at any case temperature by using the appropriate curve on Figure 30.

$T_J(pk)$ may be calculated from the data in Figure 31. At any case temperatures, thermal limitations will reduce the power that can be handled to values less than the limitations imposed by second breakdown. For inductive loads, high voltage and current must be sustained simultaneously during turn-off with the base-to-emitter junction reverse biased. The safe level is specified as a reverse-biased safe operating area (Figure 29). This rating is verified under clamped conditions so that the device is never subjected to an avalanche mode.

TYPICAL THERMAL RESPONSE

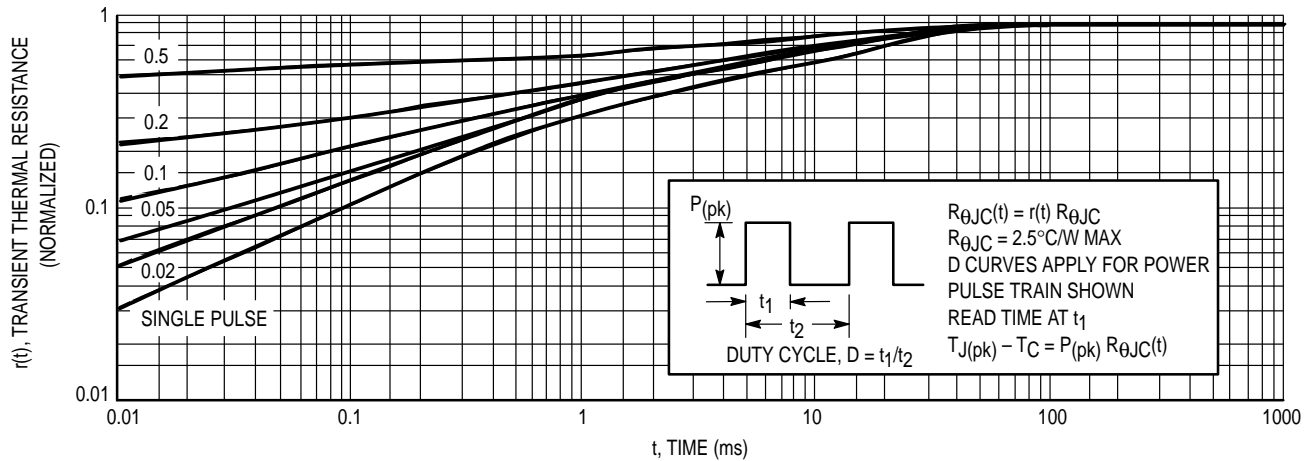
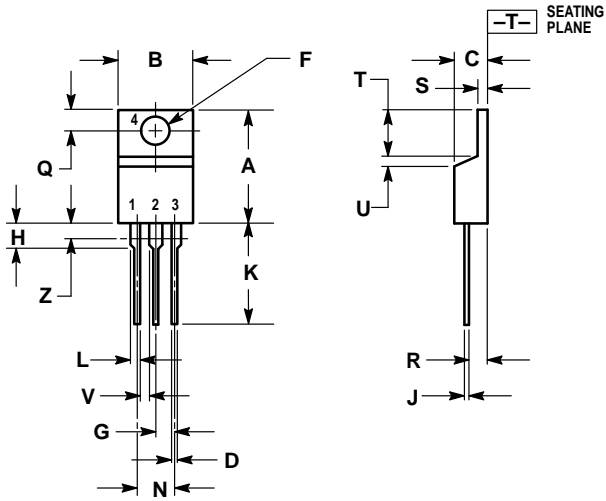

Figure 31. Typical Thermal Response ($Z_{\theta JC}(t)$) for MJE18004D2

PACKAGE DIMENSIONS



- NOTES:
1. DIMENSIONING AND TOLERANCING PER ANSI Y14.5M, 1982.
 2. CONTROLLING DIMENSION: INCH.
 3. DIMENSION Z DEFINES A ZONE WHERE ALL BODY AND LEAD IRREGULARITIES ARE ALLOWED.

DIM	INCHES		MILLIMETERS	
	MIN	MAX	MIN	MAX
A	0.570	0.620	14.48	15.75
B	0.380	0.405	9.66	10.28
C	0.160	0.190	4.07	4.82
D	0.025	0.035	0.64	0.88
F	0.142	0.147	3.61	3.73
G	0.095	0.105	2.42	2.66
H	0.110	0.155	2.80	3.93
J	0.018	0.025	0.46	0.64
K	0.500	0.562	12.70	14.27
L	0.045	0.060	1.15	1.52
N	0.190	0.210	4.83	5.33
Q	0.100	0.120	2.54	3.04
R	0.080	0.110	2.04	2.79
S	0.045	0.055	1.15	1.39
T	0.235	0.255	5.97	6.47
U	0.000	0.050	0.00	1.27
V	0.045	—	1.15	—
Z	—	0.080	—	2.04

- STYLE 1:
 PIN 1. BASE
 2. COLLECTOR
 3. EMITTER
 4. COLLECTOR

CASE 221A-06
 TO-220AB
 ISSUE Y

MJE18004D2

Motorola reserves the right to make changes without further notice to any products herein. Motorola makes no warranty, representation or guarantee regarding the suitability of its products for any particular purpose, nor does Motorola assume any liability arising out of the application or use of any product or circuit, and specifically disclaims any and all liability, including without limitation consequential or incidental damages. "Typical" parameters can and do vary in different applications. All operating parameters, including "Typicals" must be validated for each customer application by customer's technical experts. Motorola does not convey any license under its patent rights nor the rights of others. Motorola products are not designed, intended, or authorized for use as components in systems intended for surgical implant into the body, or other applications intended to support or sustain life, or for any other application in which the failure of the Motorola product could create a situation where personal injury or death may occur. Should Buyer purchase or use Motorola products for any such unintended or unauthorized application, Buyer shall indemnify and hold Motorola and its officers, employees, subsidiaries, affiliates, and distributors harmless against all claims, costs, damages, and expenses, and reasonable attorney fees arising out of, directly or indirectly, any claim of personal injury or death associated with such unintended or unauthorized use, even if such claim alleges that Motorola was negligent regarding the design or manufacture of the part. Motorola and  are registered trademarks of Motorola, Inc. Motorola, Inc. is an Equal Opportunity/Affirmative Action Employer.

How to reach us:

USA / EUROPE: Motorola Literature Distribution;
P.O. Box 20912; Phoenix, Arizona 85036. 1-800-441-2447

MFAX: RMFAX0@email.sps.mot.com – TOUCHTONE (602) 244-6609
INTERNET: <http://Design-NET.com>

JAPAN: Nippon Motorola Ltd.; Tatsumi-SPD-JLDC, Toshikatsu Otsuki,
6F Seibu-Butsuryu-Center, 3-14-2 Tatsumi Koto-Ku, Tokyo 135, Japan. 03-3521-8315

HONG KONG: Motorola Semiconductors H.K. Ltd.; 8B Tai Ping Industrial Park,
51 Ting Kok Road, Tai Po, N.T., Hong Kong. 852-26629298

