

# Designer's™ Data Sheet

## SWITCHMODE™ NPN Bipolar Power Transistor for Electronic Light Ballast and Switching Power Supply Applications

**MJE18204**  
**MJF18204**

POWER TRANSISTORS  
 5 AMPERES  
 1200 VOLTS  
 35 and 75 WATTS

The MJE/MJF18204 have an application specific state-of-the-art die dedicated to the electronic ballast ("light ballast") and power supply applications.

- Improved Global Efficiency Due to Low Base Drive Requirements:
  - High and Flat DC Current Gain  $h_{FE}$
  - Fast Switching
  - No Coil Required in Base Circuit for Fast Turn-Off (No Current Tail)
- Full Characterization at 125°C
- Motorola "6 SIGMA" Philosophy Provides Tight and Reproducible Parametric Distributions
- Two Package Choices: Standard TO-220 or Isolated TO-220

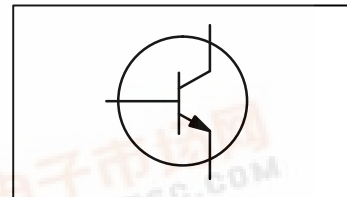

### MAXIMUM RATINGS

Rating	Symbol	MJE18204	MJF18204	Unit	
Collector-Emitter Voltage	$V_{CEO}$	600		Vdc	
Collector-Base Voltage	$V_{CBO}$	1200		Vdc	
Collector-Emitter Voltage	$V_{CES}$	1200		Vdc	
Emitter-Base Voltage	$V_{EBO}$	10		Vdc	
Collector Current — Continuous	$I_C$	5		Adc	
— Peak (1)	$I_{CM}$	10			
Base Current — Continuous	$I_B$	2		Adc	
— Peak (1)	$I_{BM}$	4			
RMS Isolation Voltage (2) (for 1 sec, R.H. $\leq$ 30%) $T_C = 25^\circ\text{C}$	Per Figure 22 Per Figure 23 Per Figure 24	$V_{ISOL1}$ $V_{ISOL2}$ $V_{ISOL3}$		4500 3500 1500	Volts
*Total Device Dissipation @ $T_C = 25^\circ\text{C}$ *Derate above $25^\circ\text{C}$	$P_D$	75 0.6	35 0.28	Watt W/ $^\circ\text{C}$	
Operating and Storage Temperature	$T_J, T_{stg}$	-65 to 150		$^\circ\text{C}$	

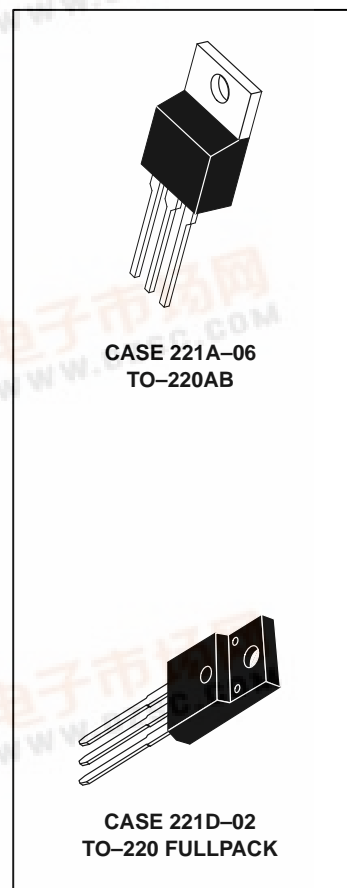

### THERMAL CHARACTERISTICS

Rating	Symbol	MJE18204	MJF18204	Unit
Thermal Resistance — Junction to Case	$R_{\theta JC}$	1.65	3.55	$^\circ\text{C}/\text{W}$
— Junction to Ambient	$R_{\theta JA}$	62.5	62.5	
Maximum Lead Temperature for Soldering Purposes: 1/8" from Case for 5 Seconds	$T_L$	260		$^\circ\text{C}$

- Pulse Test: Pulse Width = 5 ms, Duty Cycle  $\leq$  10%.
- Proper strike and creepage distance must be provided.

Designer's Data for "Worst Case" Conditions — The Designer's Data Sheet permits the design of most circuits entirely from the information presented. SOA Limit curves — representing boundaries on device characteristics — are given to facilitate "worst case" design.

Designer's and SWITCHMODE are trademarks of Motorola, Inc.



# MJE18204 MJF18204

## ELECTRICAL CHARACTERISTICS (T<sub>C</sub> = 25°C unless otherwise noted)

Characteristic	Symbol	Min	Typ	Max	Unit
----------------	--------	-----	-----	-----	------

### OFF CHARACTERISTICS

Collector–Emitter Voltage (I <sub>C</sub> = 1 mA, I <sub>B</sub> = 0)	V <sub>CEO</sub>	600	660		Vdc
Collector–Emitter Sustaining Voltage (I <sub>C</sub> = 100 mA, L = 25 mH) (I <sub>C</sub> = 200 mA, L = 25 mH, R = 2 Ω)	V <sub>CEO(sus)</sub> V <sub>CER(sus)</sub>	550 600	630 700		Vdc
Collector–Base Breakdown Voltage (I <sub>CBO</sub> = 1 mA, I <sub>E</sub> = 0)	V <sub>CB0</sub>	1200	1300		Vdc
Emitter–Base Breakdown Voltage (I <sub>EBO</sub> = 1 mA, I <sub>C</sub> = 0)	V <sub>EBO</sub>	10	12.9		Vdc
Collector Cutoff Current (V <sub>CE</sub> = 600 V, I <sub>B</sub> = 0) (V <sub>CE</sub> = 550 V, I <sub>B</sub> = 0)	@ T <sub>C</sub> = 25°C @ T <sub>C</sub> = 125°C	I <sub>CEO</sub>		200 2000	μAdc
Collector Cutoff Current (V <sub>CE</sub> = Rated V <sub>CEs</sub> , V <sub>BE</sub> = 0) (V <sub>CE</sub> = 1000 V, V <sub>BE</sub> = 0)	@ T <sub>C</sub> = 25°C @ T <sub>C</sub> = 125°C @ T <sub>C</sub> = 125°C	I <sub>CES</sub>		100 500 100	μAdc
Collector Cutoff Current (V <sub>CB</sub> = Rated V <sub>CB</sub> , I <sub>E</sub> = 0)	I <sub>CBO</sub>			100	μAdc
Emitter–Cutoff Current (V <sub>EB</sub> = 10 Vdc, I <sub>C</sub> = 0)	I <sub>EBO</sub>			100	μAdc

### ON CHARACTERISTICS

Base–Emitter Saturation Voltage (I <sub>C</sub> = 1 Adc, I <sub>B</sub> = 0.1 Adc) (I <sub>C</sub> = 2 Adc, I <sub>B</sub> = 0.4 Adc)	V <sub>BE(sat)</sub>		0.83 0.92	1.1 1.25	Vdc
Collector–Emitter Saturation Voltage (I <sub>C</sub> = 1 Adc, I <sub>B</sub> = 0.1 Adc)  (I <sub>C</sub> = 2 Adc, I <sub>B</sub> = 0.4 Adc)	@ T <sub>C</sub> = 25°C @ T <sub>C</sub> = 125°C  @ T <sub>C</sub> = 25°C @ T <sub>C</sub> = 125°C	V <sub>CE(sat)</sub>	0.3 0.7  0.3 0.8	1 1.25  0.6 1.25	Vdc
DC Current Gain (I <sub>C</sub> = 0.5 Adc, V <sub>CE</sub> = 3 Vdc)  (I <sub>C</sub> = 1 Adc, V <sub>CE</sub> = 1 Vdc)  (I <sub>C</sub> = 2 Adc, V <sub>CE</sub> = 1 Vdc)  (I <sub>C</sub> = 5 mAdc, V <sub>CE</sub> = 5 Vdc)	@ T <sub>C</sub> = 25°C @ T <sub>C</sub> = 125°C  @ T <sub>C</sub> = 25°C @ T <sub>C</sub> = 125°C  @ T <sub>C</sub> = 25°C @ T <sub>C</sub> = 125°C  @ T <sub>C</sub> = 25°C @ T <sub>C</sub> = 125°C	h <sub>FE</sub>	18  10 8  5 4  10	23  13  8 6  25 33	—  —  —

### DYNAMIC CHARACTERISTICS

Current Gain Bandwidth (I <sub>C</sub> = 0.5 Adc, V <sub>CE</sub> = 10 Vdc, f = 1 MHz)	f <sub>T</sub>		13		MHz
Output Capacitance (V <sub>CB</sub> = 10 Vdc, I <sub>E</sub> = 0, f = 1 MHz)	C <sub>ob</sub>			200	pF
Input Capacitance (V <sub>EB</sub> = 8 Vdc)	C <sub>ib</sub>			2000	pF

### DYNAMIC SATURATION VOLTAGE

Dynamic Saturation Voltage: Determined 1 μs and 3 μs respectively after rising I <sub>B1</sub> reaches 90% of final I <sub>B1</sub>	I <sub>C</sub> = 2 Adc I <sub>B1</sub> = 660 mAdc V <sub>CC</sub> = 300 V	@ 3 μs	@ T <sub>C</sub> = 25°C	V <sub>CE(dsat)</sub>		2.5		V
			@ T <sub>C</sub> = 125°C			7.5		
	I <sub>C</sub> = 2 Adc I <sub>B1</sub> = 0.4 Adc V <sub>CC</sub> = 300 V	@ 3 μs	@ T <sub>C</sub> = 25°C		7			
			@ T <sub>C</sub> = 125°C		15			

**MJE18204 MJF18204**

**ELECTRICAL CHARACTERISTICS** ( $T_C = 25^\circ\text{C}$  unless otherwise noted)

Characteristic	Symbol	Min	Typ	Max	Unit
----------------	--------	-----	-----	-----	------

**SWITCHING CHARACTERISTICS: Resistive Load** (D.C.  $\leq 10\%$ , Pulse Width = 20  $\mu\text{s}$ )

Turn-on Time	$I_C = 2 \text{ Adc}$ , $I_{B1} = 0.4 \text{ Adc}$ $I_{B2} = 1 \text{ Adc}$ $V_{CC} = 300 \text{ Vdc}$	@ $T_C = 25^\circ\text{C}$	$t_{on}$		105	175	ns
Turn-off Time		@ $T_C = 25^\circ\text{C}$	$t_{off}$		1.75	2.5	$\mu\text{s}$
Turn-on Time	$I_C = 2 \text{ Adc}$ , $I_{B1} = 0.4 \text{ Adc}$ $I_{B2} = 0.4 \text{ Adc}$ $V_{CC} = 300 \text{ Vdc}$	@ $T_C = 25^\circ\text{C}$	$t_{on}$		95	200	ns
Turn-off Time		@ $T_C = 25^\circ\text{C}$	$t_{off}$		3.5	4.5	$\mu\text{s}$
Turn-on Time	$I_C = 0.7 \text{ Adc}$ , $I_{B1} = 50 \text{ mAdc}$ $I_{B2} = 0.4 \text{ Adc}$ $V_{CC} = 125 \text{ Vdc}$ $PW = 70 \mu\text{s}$	@ $T_C = 25^\circ\text{C}$	$t_d$		70	150	ns
			$t_r$		210	400	ns
Turn-off Time		@ $T_C = 25^\circ\text{C}$	$t_s$		0.9	1.2	$\mu\text{s}$
		@ $T_C = 25^\circ\text{C}$	$t_f$		275	450	ns

**SWITCHING CHARACTERISTICS: Inductive Load** ( $V_{clamp} = 300 \text{ V}$ ,  $V_{CC} = 15 \text{ V}$ ,  $L = 200 \mu\text{H}$ )

Fall Time	$I_C = 1 \text{ Adc}$ $I_{B1} = 0.1 \text{ Adc}$ $I_{B2} = 0.5 \text{ Adc}$	@ $T_C = 25^\circ\text{C}$ @ $T_C = 125^\circ\text{C}$	$t_f$		110 95	175	ns
Storage Time		@ $T_C = 25^\circ\text{C}$ @ $T_C = 125^\circ\text{C}$	$t_s$		1.35 1.9	2	$\mu\text{s}$
Crossover Time		@ $T_C = 25^\circ\text{C}$ @ $T_C = 125^\circ\text{C}$	$t_c$		150 115	250	ns
Fall Time	$I_C = 2 \text{ Adc}$ $I_{B1} = 0.4 \text{ Adc}$ $I_{B2} = 1 \text{ Adc}$	@ $T_C = 25^\circ\text{C}$ @ $T_C = 125^\circ\text{C}$	$t_f$		120 180	200	ns
Storage Time		@ $T_C = 25^\circ\text{C}$ @ $T_C = 125^\circ\text{C}$	$t_s$		1.9 2.35	2.75	$\mu\text{s}$
Crossover Time		@ $T_C = 25^\circ\text{C}$ @ $T_C = 125^\circ\text{C}$	$t_c$		190 180	300	ns
Fall Time	$I_C = 2 \text{ Adc}$ $I_{B1} = 0.4 \text{ Adc}$ $I_{B2} = 0.4 \text{ Adc}$	@ $T_C = 25^\circ\text{C}$	$t_f$		185	300	ns
Storage Time		@ $T_C = 25^\circ\text{C}$	$t_s$		4	5	$\mu\text{s}$
Crossover Time		@ $T_C = 25^\circ\text{C}$	$t_c$		350	500	ns

TYPICAL STATIC CHARACTERISTICS

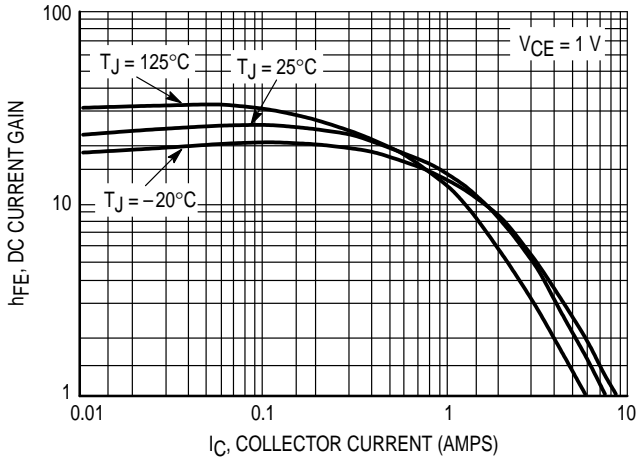

Figure 1. DC Current Gain @ 1 Volt

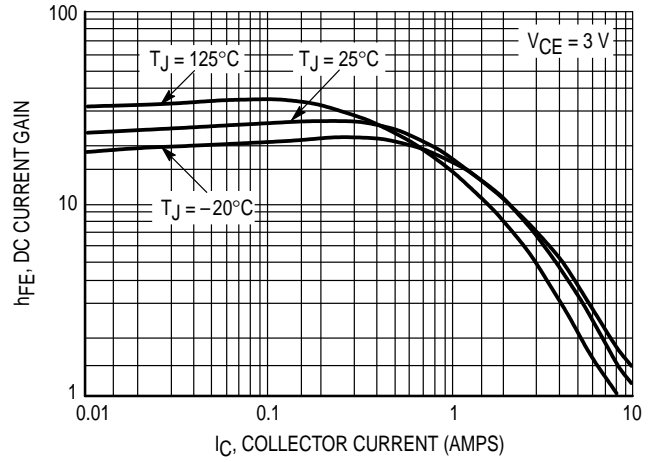

Figure 2. DC Current Gain @ 3 Volts

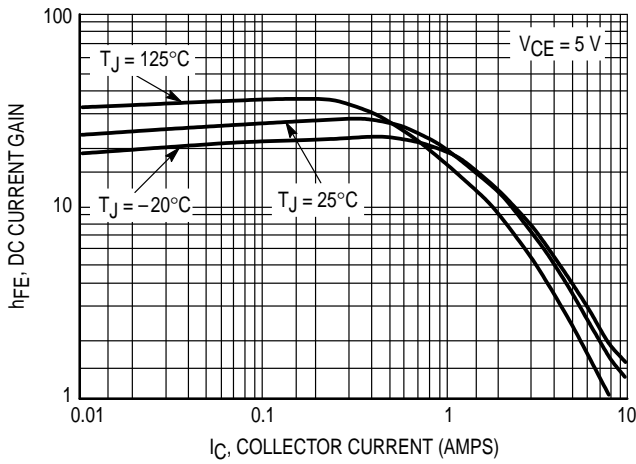

Figure 3. DC Current Gain @ 5 Volts

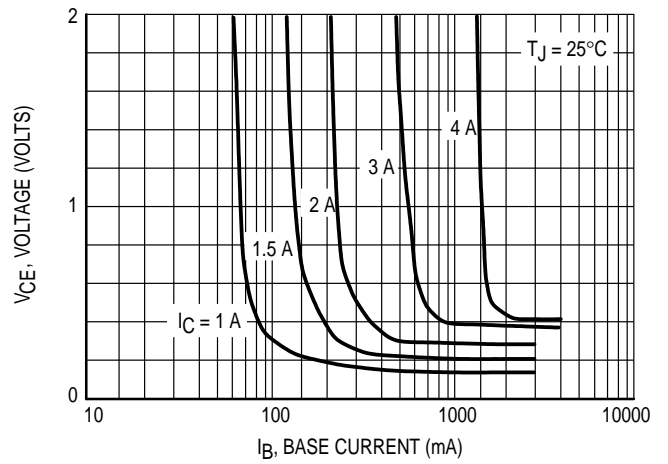

Figure 4. Collector Saturation Region

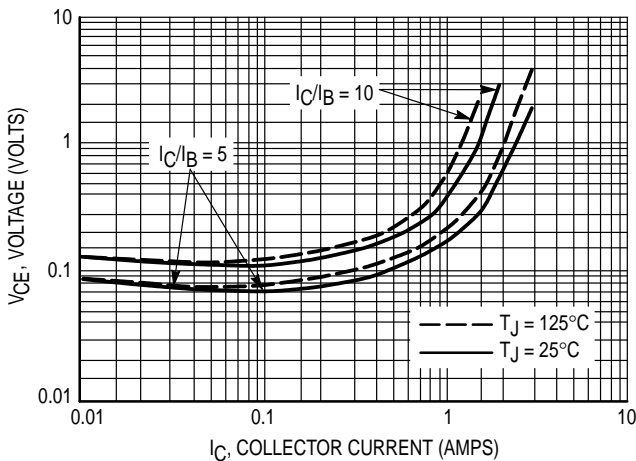

Figure 5. Collector-Emitter Saturation Voltage

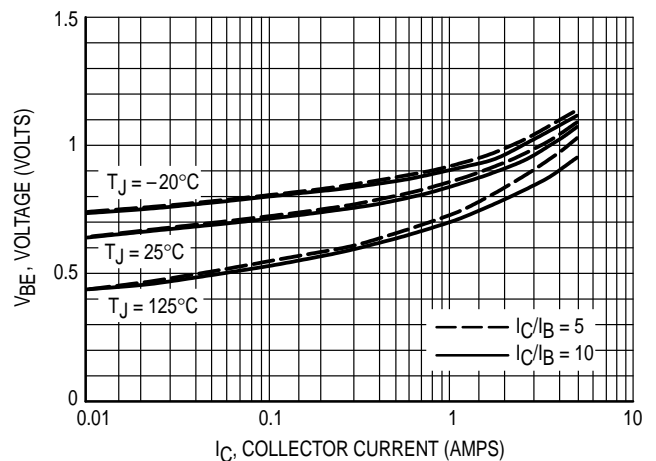

Figure 6. Base-Emitter Saturation Region

TYPICAL STATIC CHARACTERISTICS

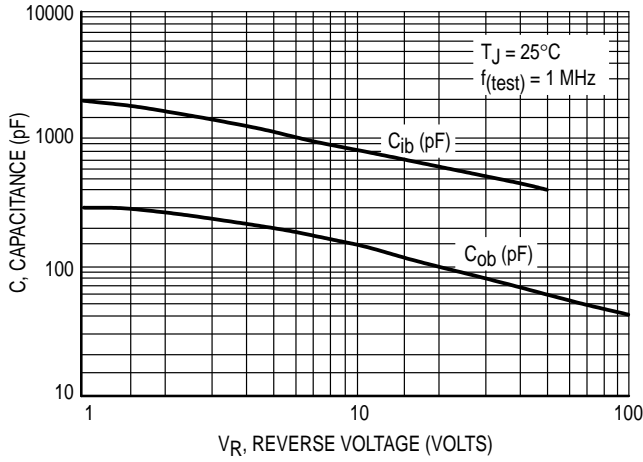

Figure 7. Capacitance

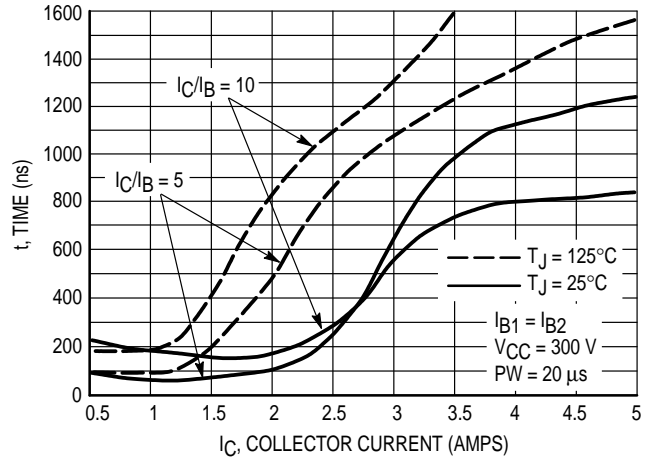

Figure 8. Resistive Switching, t<sub>on</sub>

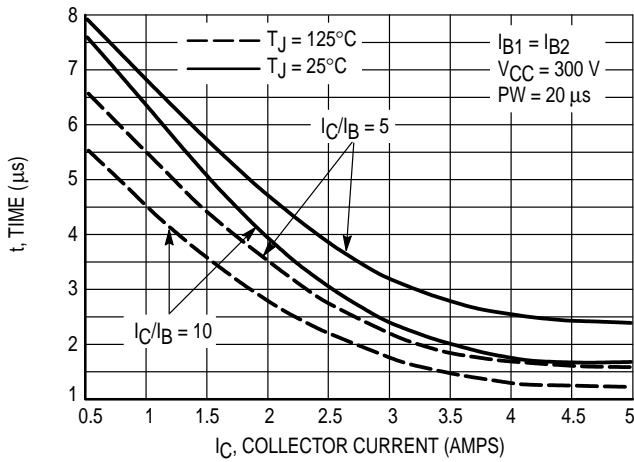

Figure 9. Resistive Switching, t<sub>off</sub>

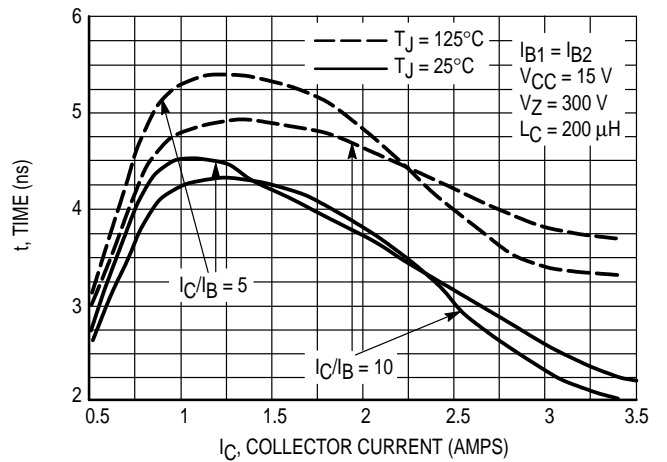

Figure 10. Inductive Storage Time, t<sub>si</sub>

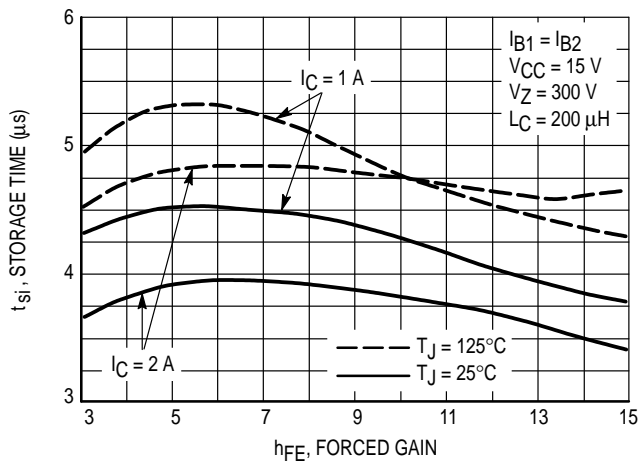

Figure 11. Inductive Storage Time, t<sub>si</sub> (h<sub>FE</sub>)

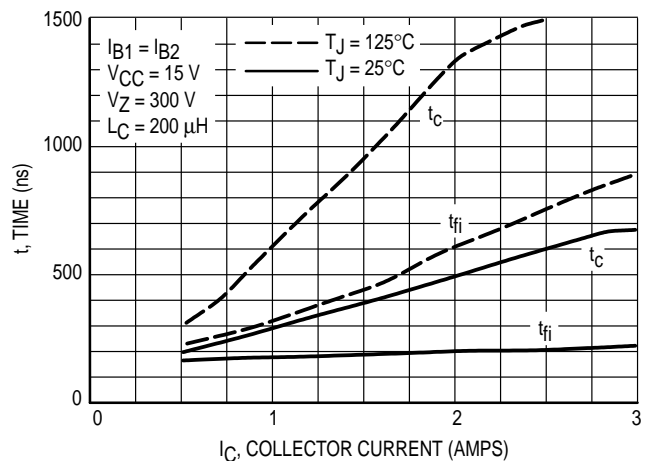
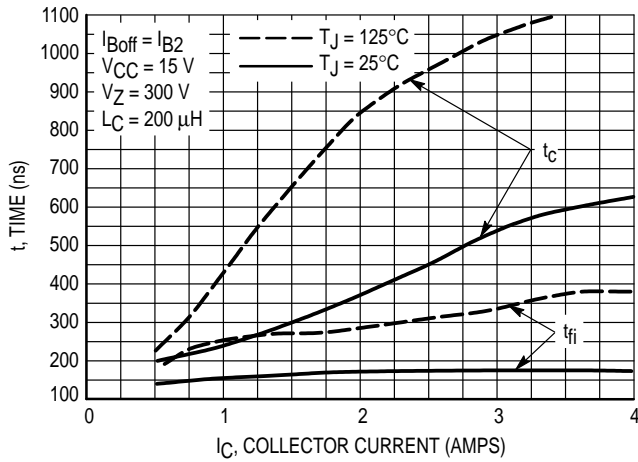

Figure 12. Inductive Switching, t<sub>c</sub> & t<sub>fi</sub> @ I<sub>C</sub>/I<sub>B</sub> = 5

**MJE18204 MJF18204**

**TYPICAL STATIC CHARACTERISTICS**



**Figure 13. Inductive Switching,  $t_c$  &  $t_{fi}$  @  $I_C/I_B = 10$**

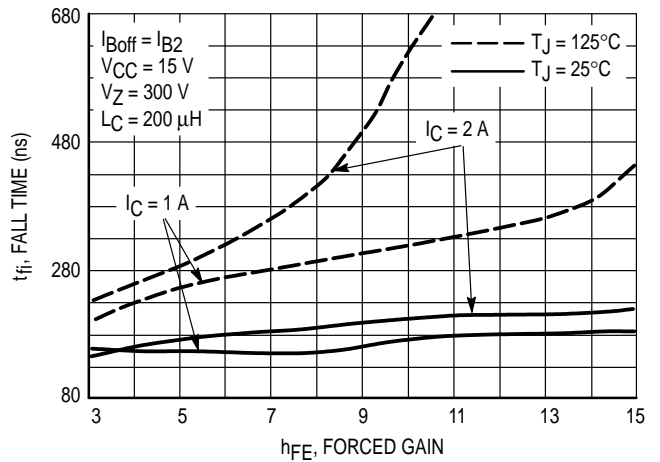

**Figure 14. Inductive Fall Time**

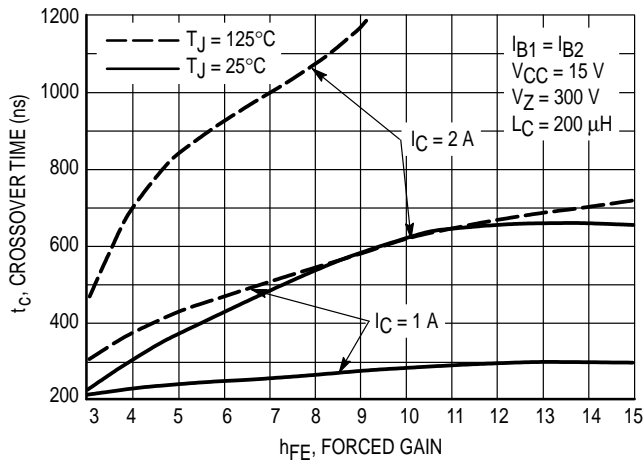

**Figure 15. Inductive Crossover Time**

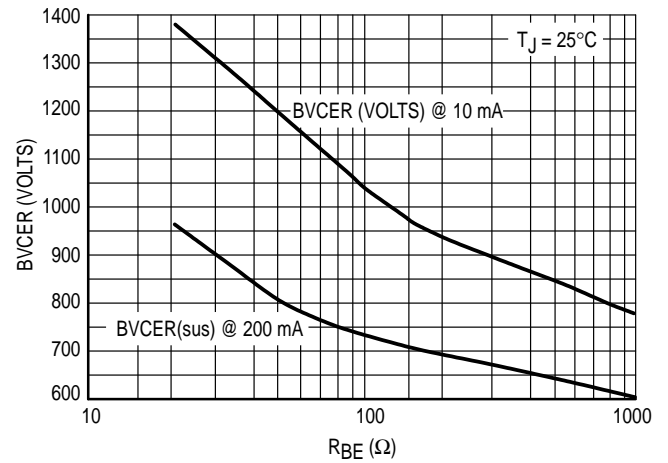

**Figure 16.  $BV_{CEr} = f(R_{BE})$**

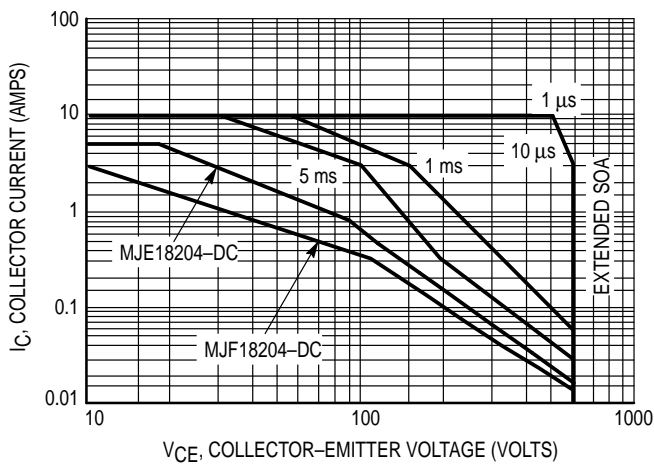

**Figure 17. Forward Bias Safe Operating Area**

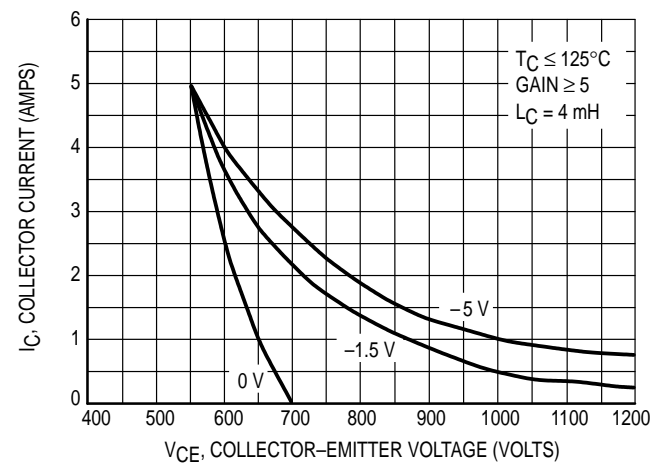

**Figure 18. Reverse Bias Switching Safe Operating Area**

TYPICAL STATIC CHARACTERISTICS

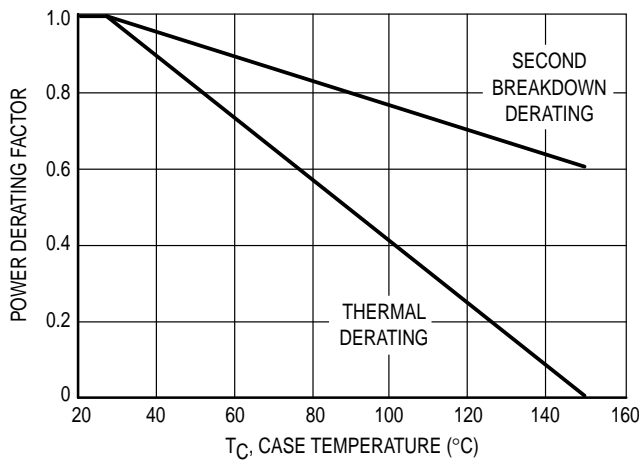

Figure 19. Forward Bias Power Derating

There are two limitations on the power handling ability of a transistor: average junction temperature and second breakdown. Safe operating area curves indicate  $I_C$ - $V_{CE}$  limits of the transistor that must be observed for reliable operation; i.e., the transistor must not be subjected to greater dissipation than the curves indicate. The data of Figure 19 is based on  $T_C = 25^\circ\text{C}$ ;  $T_J(pk)$  is variable depending on power level. Second breakdown pulse limits are valid for duty cycles to 10% but must be derated when  $T_C > 25^\circ\text{C}$ . Second breakdown limitations do not derate the same as thermal limitations. Allowable current at the voltages shown on Figure 16 may be found at any case temperature by using the appropriate curve on Figure 18.

$T_J(pk)$  may be calculated from the data in Figures 21 and 22. At any case temperatures, thermal limitations will reduce the power that can be handled to values less than the limitations imposed by second breakdown. For inductive loads, high voltage and current must be sustained simultaneously during turn-off with the base-to-emitter reverse biased. The safe level is specified as a reverse-biased safe operating area (Figure 17). This rating is verified under clamped conditions so that the device is never subjected to an avalanche mode.

TYPICAL SWITCHING CHARACTERISTICS  
( $I_{B1} = I_{B2}$  FOR ALL CURVES)

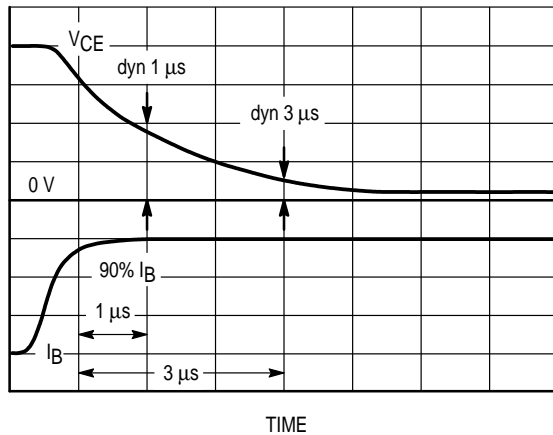

Figure 20. Dynamic Saturation Voltage Measurements

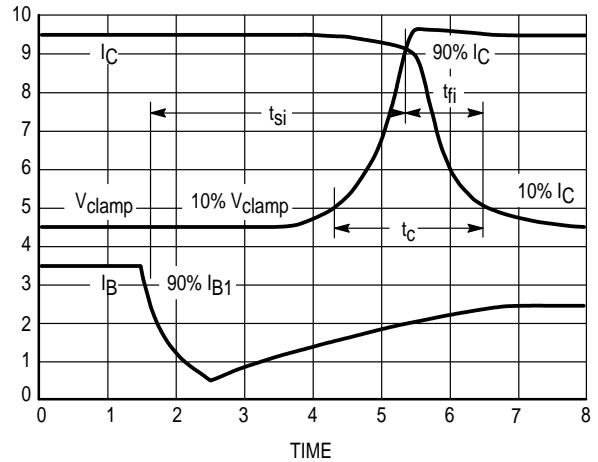
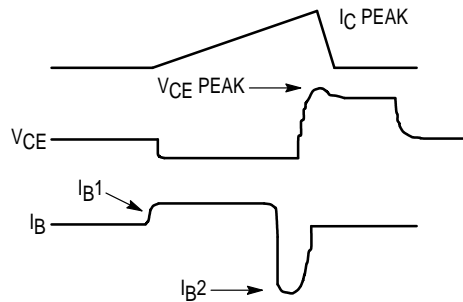
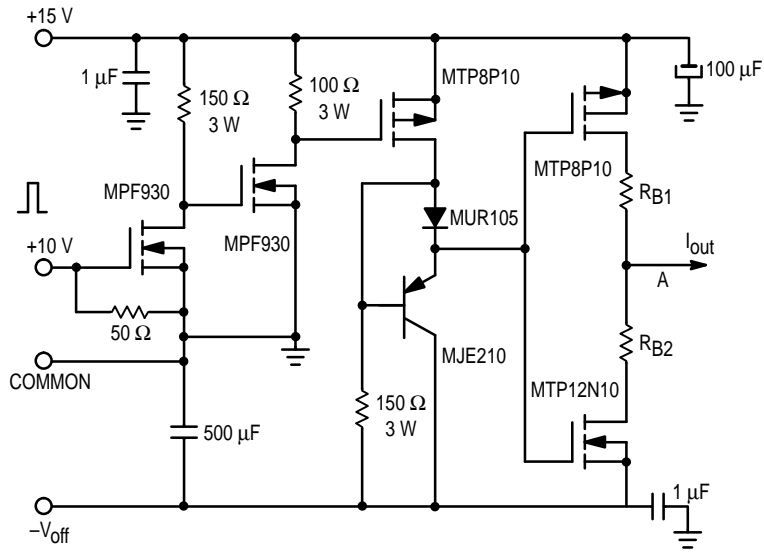

Figure 21. Inductive Switching Measurements

**MJE18204 MJF18204**

**TYPICAL SWITCHING CHARACTERISTICS  
( $I_{B1} = I_{B2}$  FOR ALL CURVES)**

**Table 1. Inductive Load Switching Drive Circuit**



**V(BR)CEO(sus)**  
 $L = 10 \text{ mH}$   
 $R_{B2} = \infty$   
 $V_{CC} = 20 \text{ Volts}$   
 $I_{C(pk)} = 100 \text{ mA}$

**Inductive Switching**  
 $L = 200 \mu\text{H}$   
 $R_{B2} = 0$   
 $V_{CC} = 15 \text{ Volts}$   
 $R_{B1}$  selected for desired  $I_{B1}$

**RBSOA**  
 $L = 500 \mu\text{H}$   
 $R_{B2} = 0$   
 $V_{CC} = 15 \text{ Volts}$   
 $R_{B1}$  selected for desired  $I_{B1}$



TYPICAL THERMAL RESPONSE  
( $I_{B1} = I_{B2}$  FOR ALL CURVES)

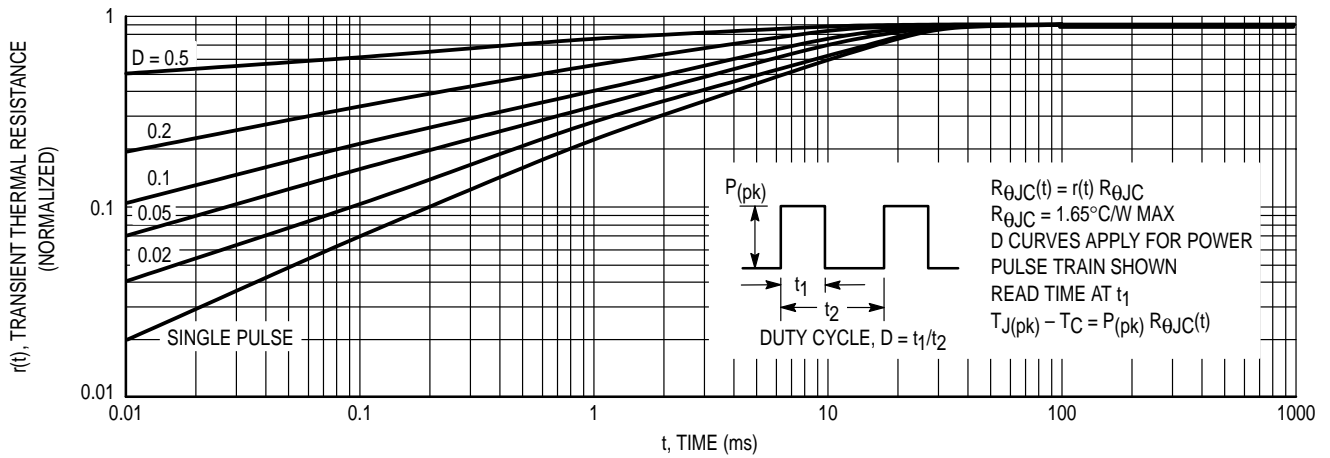

Figure 22. Typical Thermal Response ( $Z_{\theta JC}(t)$ ) for MJE18204

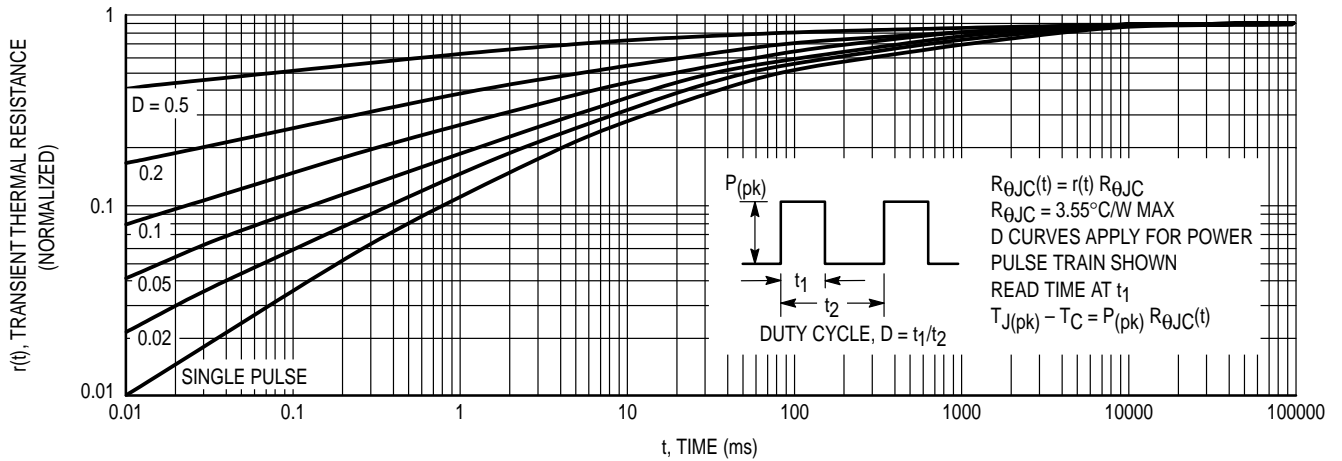
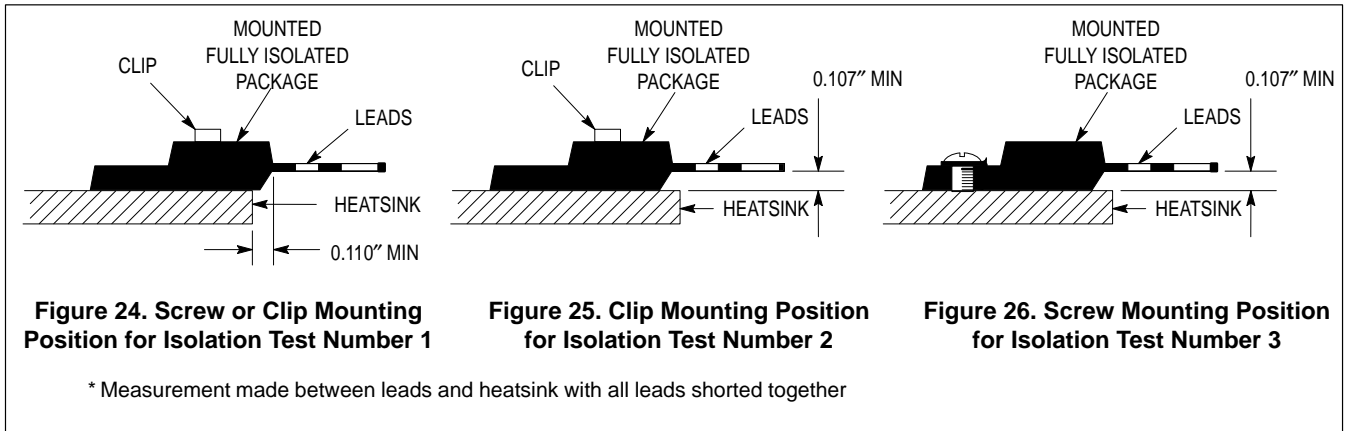
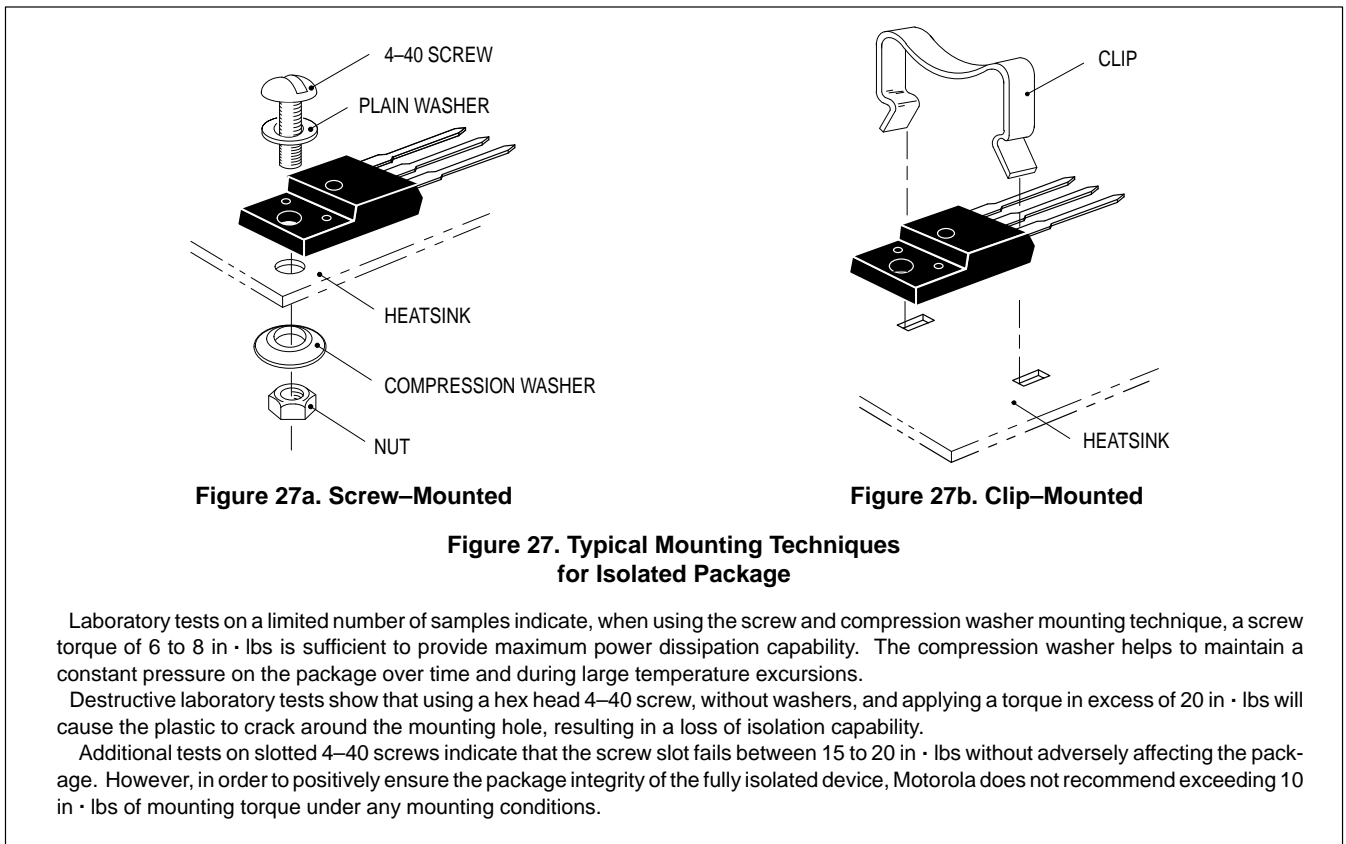

Figure 23. Typical Thermal Response ( $Z_{\theta JC}(t)$ ) for MJF18204

TEST CONDITIONS FOR ISOLATION TESTS\*



MOUNTING INFORMATION\*\*



\*\* For more information about mounting power semiconductors see Application Note AN1040.

PACKAGE DIMENSIONS

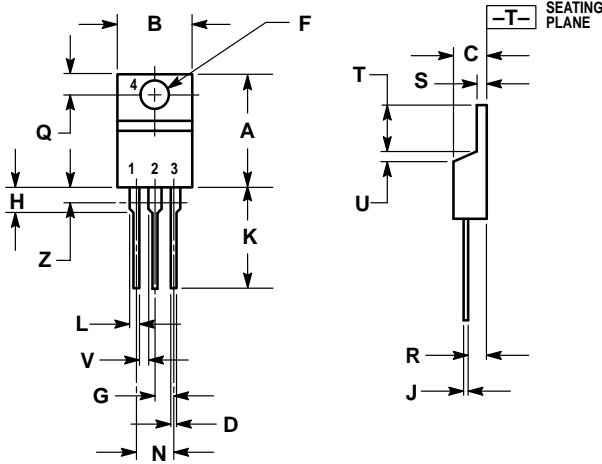

- NOTES:
1. DIMENSIONING AND TOLERANCING PER ANSI Y14.5M, 1982.
  2. CONTROLLING DIMENSION: INCH.
  3. DIMENSION Z DEFINES A ZONE WHERE ALL BODY AND LEAD IRREGULARITIES ARE ALLOWED.

DIM	INCHES		MILLIMETERS	
	MIN	MAX	MIN	MAX
A	0.570	0.620	14.48	15.75
B	0.380	0.405	9.66	10.28
C	0.160	0.190	4.07	4.82
D	0.025	0.035	0.64	0.88
F	0.142	0.147	3.61	3.73
G	0.095	0.105	2.42	2.66
H	0.110	0.155	2.80	3.93
J	0.018	0.025	0.46	0.64
K	0.500	0.562	12.70	14.27
L	0.045	0.060	1.15	1.52
N	0.190	0.210	4.83	5.33
Q	0.100	0.120	2.54	3.04
R	0.080	0.110	2.04	2.79
S	0.045	0.055	1.15	1.39
T	0.235	0.255	5.97	6.47
U	0.000	0.050	0.00	1.27
V	0.045	—	1.15	—
Z	—	0.080	—	2.04

- STYLE 1:  
 PIN 1. BASE  
 2. COLLECTOR  
 3. EMITTER  
 4. COLLECTOR

CASE 221A-06  
 TO-220AB  
 ISSUE Y

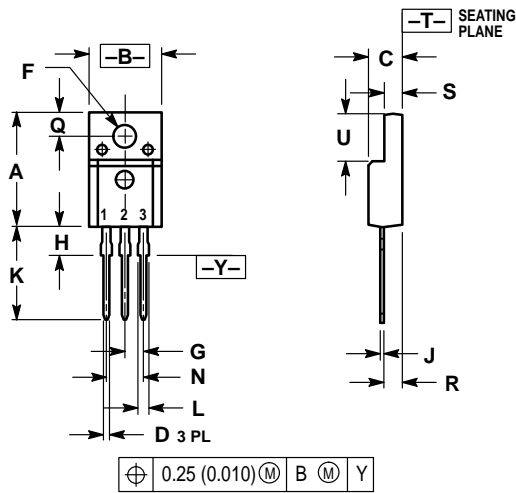

- NOTES:
1. DIMENSIONING AND TOLERANCING PER ANSI Y14.5M, 1982.
  2. CONTROLLING DIMENSION: INCH.

DIM	INCHES		MILLIMETERS	
	MIN	MAX	MIN	MAX
A	0.621	0.629	15.78	15.97
B	0.394	0.402	10.01	10.21
C	0.181	0.189	4.60	4.80
D	0.026	0.034	0.67	0.86
F	0.121	0.129	3.08	3.27
G	0.100 BSC		2.54 BSC	
H	0.123	0.129	3.13	3.27
J	0.018	0.025	0.46	0.64
K	0.500	0.562	12.70	14.27
L	0.045	0.060	1.14	1.52
N	0.200 BSC		5.08 BSC	
Q	0.126	0.134	3.21	3.40
R	0.107	0.111	2.72	2.81
S	0.096	0.104	2.44	2.64
U	0.259	0.267	6.58	6.78

- STYLE 1:  
 PIN 1. GATE  
 2. DRAIN  
 3. SOURCE

CASE 221D-02  
 (ISOLATED TO-220 TYPE)  
 UL RECOGNIZED: FILE #E69369  
 ISSUE D

## MJE18204 MJF18204

Motorola reserves the right to make changes without further notice to any products herein. Motorola makes no warranty, representation or guarantee regarding the suitability of its products for any particular purpose, nor does Motorola assume any liability arising out of the application or use of any product or circuit, and specifically disclaims any and all liability, including without limitation consequential or incidental damages. "Typical" parameters can and do vary in different applications. All operating parameters, including "Typicals" must be validated for each customer application by customer's technical experts. Motorola does not convey any license under its patent rights nor the rights of others. Motorola products are not designed, intended, or authorized for use as components in systems intended for surgical implant into the body, or other applications intended to support or sustain life, or for any other application in which the failure of the Motorola product could create a situation where personal injury or death may occur. Should Buyer purchase or use Motorola products for any such unintended or unauthorized application, Buyer shall indemnify and hold Motorola and its officers, employees, subsidiaries, affiliates, and distributors harmless against all claims, costs, damages, and expenses, and reasonable attorney fees arising out of, directly or indirectly, any claim of personal injury or death associated with such unintended or unauthorized use, even if such claim alleges that Motorola was negligent regarding the design or manufacture of the part. Motorola and  are registered trademarks of Motorola, Inc. Motorola, Inc. is an Equal Opportunity/Affirmative Action Employer.

### How to reach us:

**USA / EUROPE:** Motorola Literature Distribution;  
P.O. Box 20912; Phoenix, Arizona 85036. 1-800-441-2447

**MFAX:** RMFAX0@email.sps.mot.com – TOUCHTONE (602) 244-6609  
**INTERNET:** <http://Design-NET.com>

**JAPAN:** Nippon Motorola Ltd.; Tatsumi-SPD-JLDC, Toshikatsu Otsuki,  
6F Seibu-Butsuryu-Center, 3-14-2 Tatsumi Koto-Ku, Tokyo 135, Japan. 03-3521-8315

**HONG KONG:** Motorola Semiconductors H.K. Ltd.; 8B Tai Ping Industrial Park,  
51 Ting Kok Road, Tai Po, N.T., Hong Kong. 852-26629298

