

HEADPHONE

SRS Headphone 3D SURROUND PROCESSOR

GENERAL DESCRIPTION

The NJM2190 is a headphone surround processor based on SRS technology. It provides a realistic and spacious listening experience through standard headphones.

The features of low operating voltage, low output noise, and low operating current are very suitable for portable audio applications.

PACKAGE OUTLINE

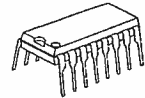

NJM2190D

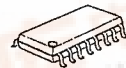

NJM2190M

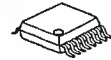

NJM2190V

FEATURES

- Operating Voltage (1.8 to 6.0V)
- Low Operating Current (1.3mA typ. at SRS mode)
- Low Output Noise (12.0μVrms typ. at SRS mode)
- WIDTH Control
- Bipolar Technology
- Package Outline DIP16, DMP16, SSOP16

PIN CONFIGURATION

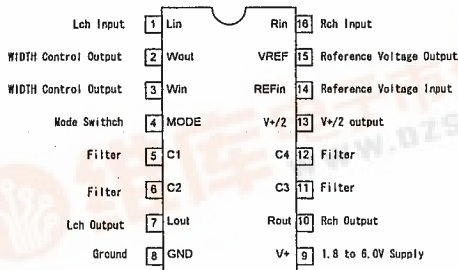

BLOCK DIAGRAM

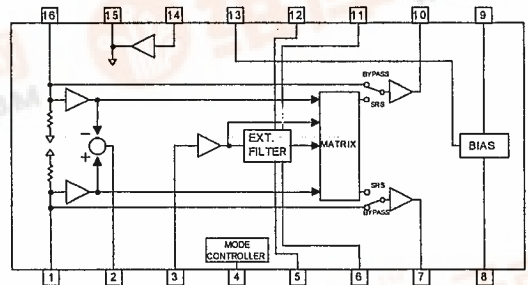

SRS Headphone is a trademark of SRS Labs, Inc. SRS and the SRS symbol are registered trademarks of SRS Labs, Inc. SRS Headphone technology is incorporated under license from SRS Labs, Inc., and protected under patents either issued or pending in selected countries worldwide.

For further information, please contact:

SRS Labs, Inc.

2909 Daimler Street, Santa Ana, CA 92705 USA

Tel: 714-442-1070 Fax: 714-852-1099 <http://www.srslabs.com>



NJM2190

■ ABSOLUTE MAXIMUM RATING (Ta=25°C)

| PARAMETER | SYMBOL | RATINGS | UNIT |
|-----------------------------|--------------------|--|------|
| Supply Voltage | V ⁺ | 7 | V |
| Power Dissipation | P _D | (DIP16) 500 (DMP16) 300 (SSOP16) 300 | mW |
| Operating Temperature Range | T _{o p r} | -20 to +75 | °C |
| Storage Temperature Range | T _{s t g} | -40 to +125 | °C |

■ ELECTRICAL CHARACTERISTICS (V⁺=3V, V_{IN}=-26dBV (50mVrms), Ta=25°C, unless otherwise specified.)

| PARAMETER | SYMBOL | | CONDITION | | | | | MIN | TYP | MAX | UNIT |
|-----------------------|------------------|---|-----------------|-----------------|--------|--------|-----------------|---------------|----------------|-----|----------------|
| | | | INPUT | | OUTPUT | MODE | WIDTH VR(*1) | | | | |
| | | | L | R | | | | | | | |
| Operating Voltage | V ⁺ | | - | - | - | - | - | 1.8 | 3.0 | 6.0 | V |
| Operating Current | I _{CC} | No Signal | 0 | 0 | - | BYPASS | - | - | 0.7 | 1.0 | mA |
| | | | 0 | 0 | - | SRS | MIN | - | 1.3 | 1.8 | |
| | | | 0 | 0 | - | SRS | MAX | - | 1.3 | 1.8 | |
| Reference Voltage | V _{REF} | V ⁺ /2 | - | - | - | - | - | 1.3 | 1.5 | 1.7 | V |
| Maximum Input Voltage | V _{IM} | f=1kHz THD=1% | V _{IN} | 0 | L | BYPASS | - | - | 0.1 (1012) | - | dBV (mVrms) |
| | | | 0 | V _{IN} | R | | | | | | |
| | | f=100Hz THD=1% | V _{IN} | 0 | L | SRS | MIN | - | -11.8 (257) | - | |
| | | | 0 | V _{IN} | R | | | | | | |
| | | f=100Hz THD=1% | V _{IN} | 0 | L | SRS | MAX | - | -15.8 (162) | - | |
| | | | 0 | V _{IN} | R | | | | | | |
| | | V ⁺ =1.8V f=1kHz THD=1% | V _{IN} | 0 | L | BYPASS | - | -6.7 (462) | -4.7 (582) | - | |
| | | | 0 | V _{IN} | R | | | | | | |
| | | V ⁺ =1.8V f=100Hz THD=1% | V _{IN} | 0 | L | SRS | MIN | - | -16.7 (146) | - | |
| | | | 0 | V _{IN} | R | | | | | | |
| | | V ⁺ =1.8V f=100Hz THD=1% | V _{IN} | 0 | L | SRS | MAX | -22.5 (75) | -20.5 (94) | - | |
| | | | 0 | V _{IN} | R | | | | | | |

■ ELECTRICAL CHARACTERISTICS ($V^+=3V, V_{IN}=-26dBV(50mV_{rms}), T_a=25^\circ C$, unless otherwise specified.)

| PARAMETER | SYMBOL | | CONDITION | | | | | MIN | TYP | MAX | UNIT |
|-------------------------------|------------|----------------------------------|-----------|----------|---------------|---------------|----------------------------|------|----------------|---------------|--------------------------|
| | | | INPUT | | OUTPUT | MODE | WIDTH VR ^(*) | | | | |
| | | | L | R | | | | | | | |
| Maximum Input Voltage (*2) | V_{IM} | $V^+=1.8V$ $f=1kHz$ THD=1% | V_{IN} | V_{IN} | L | SRS | MIN | - | -16.7 (146) | - | dBV (mVrms) |
| | | | | | R | | | | | | |
| | | | V_{IN} | V_{IN} | L | SRS | MAX | - | -16.7 (146) | - | |
| | | | | | R | | | | | | |
| V_{IN} | $-V_{IN}$ | L | SRS | MIN | - | -22.9 (72) | - | | | | |
| | | R | | | | | | | | | |
| V_{IN} | $-V_{IN}$ | L | SRS | MAX | -28.5 (38) | -26.5 (47) | - | | | | |
| | | R | | | | | | | | | |
| Output Noise | V_{NO} | $R_g=0\Omega$ A-Weighted | 0 | 0 | L | BYPASS | - | - | -110 (3.0) | -104 (6.0) | dBV (μV_{rms}) |
| | | | | | R | | | | | | |
| | | | 0 | 0 | L | SRS | MIN | - | -98 (12.0) | - | |
| | | | | | R | | | | | | |
| | | | 0 | 0 | L | SRS | MAX | - | -98 (12.0) | -92 (24.0) | |
| | | | | | R | | | | | | |
| Total Harmonic Distortion | THD | $V^+=1.8V$ $f=1kHz$ | V_{IN} | 0 | L | BYPASS | - | - | 0.02 | - | % |
| | | | | | R | | | | | | |
| | | | V_{IN} | 0 | L | SRS | MIN | - | 0.10 | - | |
| | | | | | R | | | | | | |
| | | | V_{IN} | V_{IN} | L | SRS | MAX | - | 0.25 | 0.5 | |
| | | | | | R | | | | | | |
| 0 | V_{IN} | L | SRS | MAX | - | 0.25 | 0.5 | | | | |
| | | R | | | | | | | | | |
| BYPASS Gain | G_{VBYP} | $f=1kHz$ | V_{IN} | 0 | L | BYPASS | - | -1.0 | 0.0 | 1.0 | dB |
| | | | | | R | | | | | | |
| L + R Gain | G_{L+R} | $f=1kHz$ | V_{IN} | V_{IN} | L | SRS | MIN | - | 0.0 | - | dB |
| | | | | | R | | | | | | |
| | | | V_{IN} | V_{IN} | L | SRS | MAX | -1.0 | 0.0 | 1.0 | |
| | | | | | R | | | | | | |

NJM2190

■ ELECTRICAL CHARACTERISTICS ($V^+=3V$, $V_{IN}=-26dBV$ (50mVrms), $T_a=25^\circ C$, unless otherwise specified.)

| PARAMETER | SYMBOL | | CONDITION | | | | | MIN | TYP | MAX | UNIT |
|-----------------------------|-----------|------------|-----------|-----------|--------|--------|----------------------------|------|------|-------|------|
| | | | INPUT | | OUTPUT | MODE | WIDTH VR ^(*) | | | | |
| | | | L | R | | | | | | | |
| L-R Gain (*2) | G_{L-R} | $f=100Hz$ | V_{IN} | $-V_{IN}$ | L | SRS | MIN | 3.7 | 5.7 | 7.7 | dB |
| | | | | | R | | | | | | |
| | | | V_{IN} | $-V_{IN}$ | L | SRS | MAX | 19.3 | 21.3 | 23.3 | |
| | | | | | R | | | | | | |
| Channel Separation | CS | $f=1kHz$ | 0 | V_{IN} | L | BYPASS | - | 60.0 | 80.0 | - | dB |
| | | | V_{IN} | 0 | R | | | | | | |
| MODE Select Control Voltage | V_{IH} | High Level | - | - | - | - | - | 1.3 | - | V^+ | V |
| | V_{IL} | Low Level | - | - | - | - | - | 0.0 | - | 0.5 | |

(*1) Refer to application circuit 1.

(*2) The word ' $-V_{IN}$ ' signifies opposite phase of ' V_{IN} '.

4

■ MODE Switch

| | MODE |
|-------------|------|
| BYPASS MODE | L |
| SRS MODE | H |

■ TERMINAL DESCRIPTION

| PIN NO. | SYMBOL | FUNCTION | EQUIVALENT CIRCUIT | VOLTAGE |
|---------|------------|----------------------|--------------------|---------|
| 1 16 | Lin Rin | Audio Input | | $V^+/2$ |
| 2 | Wout | WIDTH Control Output | | $V^+/2$ |
| 3 | Win | WIDTH Control Input | | $V^+/2$ |
| 4 | MODE | Mode Switch | | - |

NJM2190

■ TERMINAL DESCRIPTION

| PIN NO. | SYMBOL | FUNCTION | EQUIVALENT CIRCUIT | VOLTAGE |
|---------|--------------|---------------------------------|--------------------|---------|
| 5 | C1 | Capacitor Terminal 1 for Filter | | $V^+/2$ |
| 6 | C2 | Capacitor Terminal 2 for Filter | | $V^+/2$ |
| 7 10 | Lout Rout | Audio Output | | $V^+/2$ |
| 8 | GND | Ground | | 0V |

4

■ TERMINAL DESCRIPTION

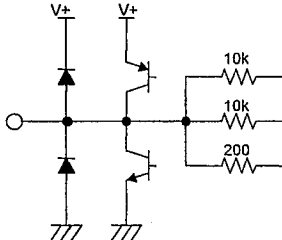
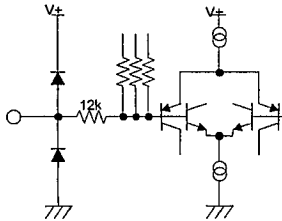
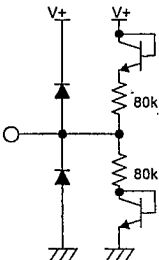
| PIN NO. | SYMBOL | FUNCTION | EQUIVALENT CIRCUIT | VOLTAGE |
|---------|--------|---------------------------------|--|---------|
| 9 | V+ | Power Supply |  | V+ |
| 11 | C3 | Capacitor Terminal 3 for Filter |  | V+/2 |
| 12 | C4 | Capacitor Terminal 4 for Filter |  | V+/2 |
| 13 | V+/2 | V+/2 Output |  | V+/2 |

NJM2190

■ TERMINAL DESCRIPTION

| PIN NO. | SYMBOL | FUNCTION | EQUIVALENT CIRCUIT | VOLTAGE |
|---------|--------|--------------------------|--------------------|---------|
| 14 | REFin | Reference Voltage Input | | $V^+/2$ |
| 15 | VREF | Reference Voltage Output | | $V^+/2$ |

APPLICATION CIRCUIT 1

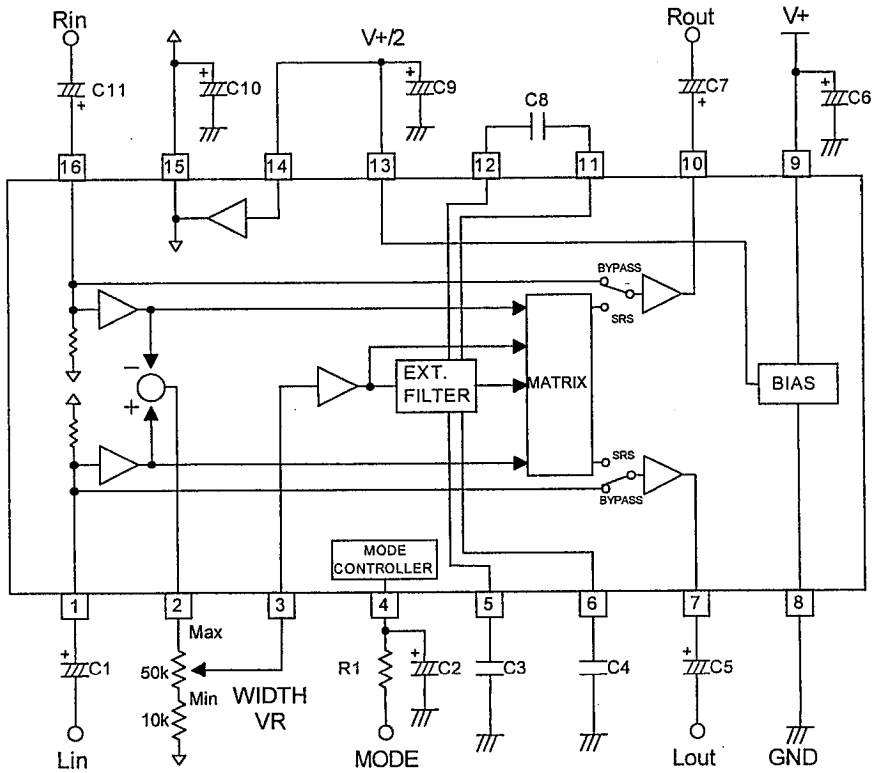

| Parts No. | Value | Tolerance | Parts No. | Value | Tolerance |
|-----------|-------------------|-----------|-----------|-------------------------|-----------|
| R1 | 22k Ω | $\pm 5\%$ | C6 | 22 to 100 μF | - |
| C1 | 10 μF | - | C7 | 10 μF | - |
| C2 | 10 μF | - | C8 | 4.7nF | $\pm 5\%$ |
| C3 | 3.3nF | $\pm 5\%$ | C9 | 1 to 10 μF | - |
| C4 | 0.1 μF | $\pm 5\%$ | C10 | 10 to 7 μF | - |
| C5 | 10 μF | - | C11 | 10 μF | - |

NJM2190

APPLICATION CIRCUIT 2 (Without using internal $V+/2$.)

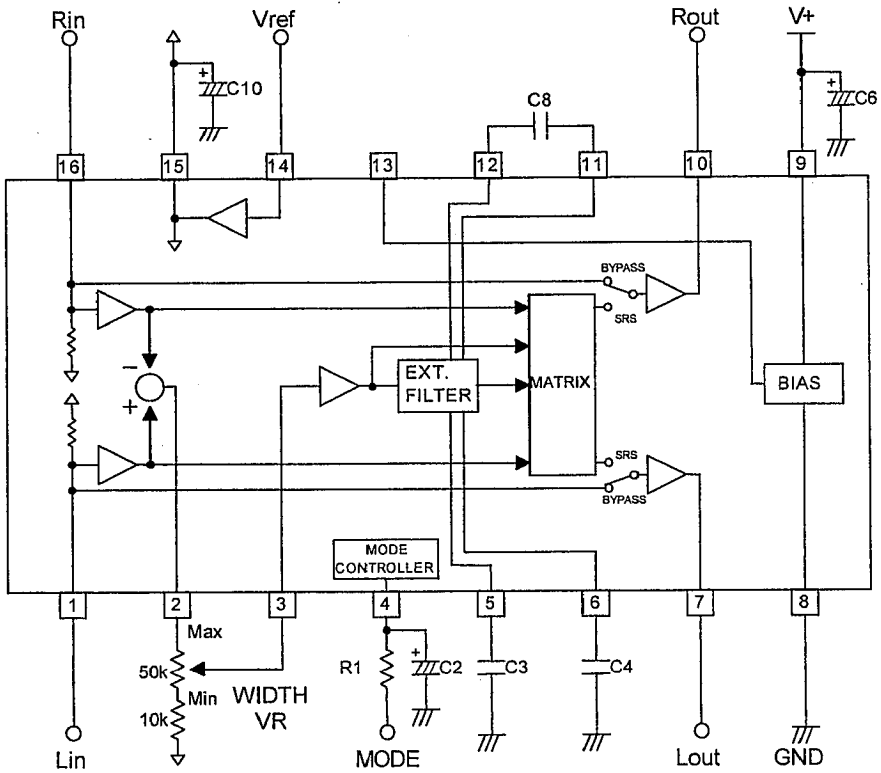

| Parts No. | Value | Tolerance | Parts No. | Value | Tolerance |
|-----------|--------------|-----------|-----------|-------------------|-----------|
| R1 | 22k Ω | $\pm 5\%$ | C6 | 22 to 100 μF | - |
| C2 | 10 μF | - | C8 | 4.7nF | $\pm 5\%$ |
| C3 | 3.3nF | $\pm 5\%$ | C10 | 10 to 47 μF | - |
| C4 | 0.1 μF | $\pm 5\%$ | | | |

■ TYPICAL CHARACTERISTICS

GAIN STRUCTURE (WIDTH VR: MAX)

Conditions : SRS MODE , WIDTH VR=MAX , V+=3V
 a:Vin=-26dBV(Lch.) Vout=Lch. b:Vin=-26dBV(Rch.) Vout=Lch.
 c:Vin=-26dBV(L+Rch.) Vout=Lch. d:Vin=-26dBV(L-Rch.) Vout=Lch.

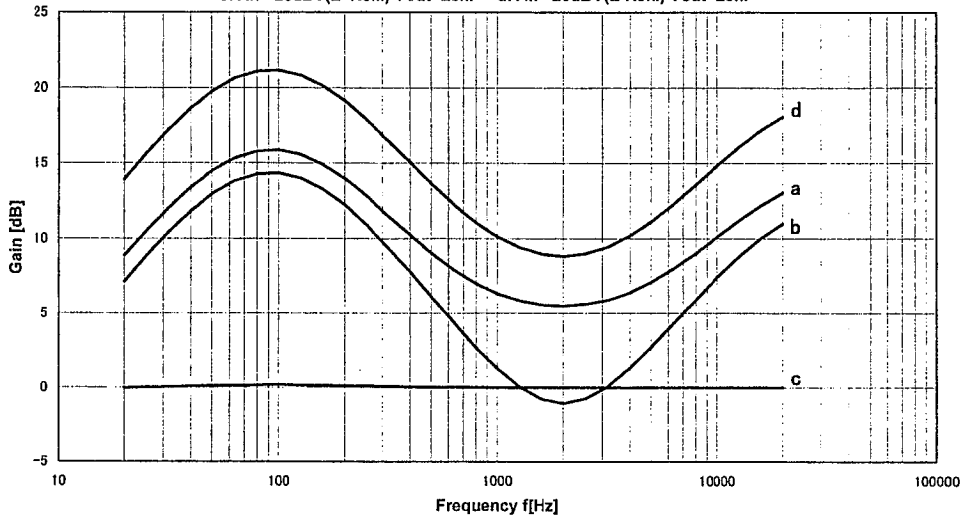

GAIN STRUCTURE (WIDTH VR: MIN)

Conditions : SRS MODE , WIDTH VR=MIN , V+=3V
 a:Vin=-26dBV(Lch.) Vout=Lch. b:Vin=-26dBV(Rch.) Vout=Lch.
 c:Vin=-26dBV(L+Rch.) Vout=Lch. d:Vin=-26dBV(L-Rch.) Vout=Lch.

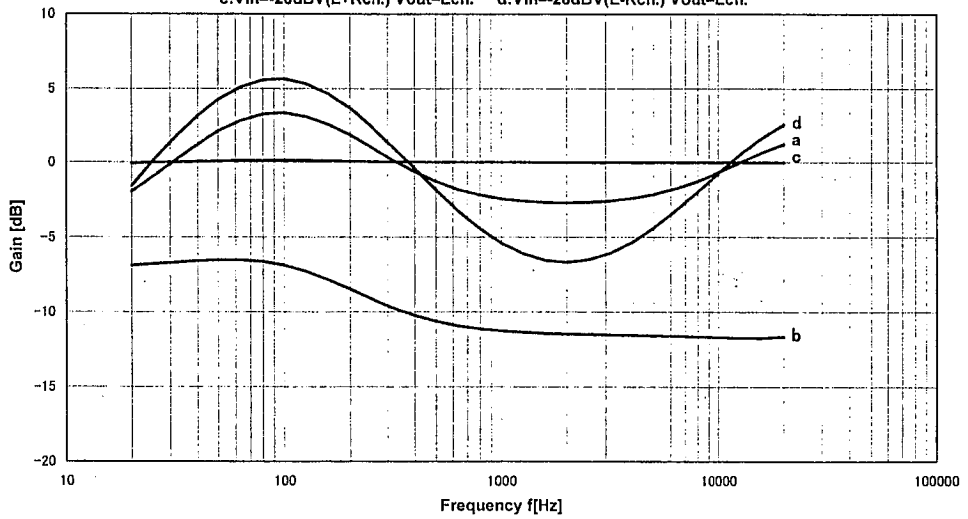

TYPICAL CHARACTERISTICS

Maximum Input Voltage vs. Supply Voltage

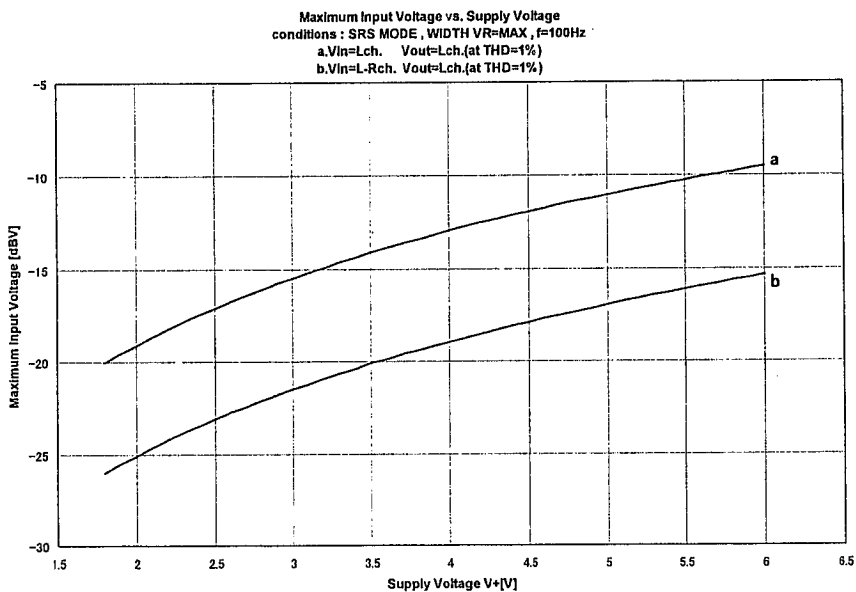

Maximum Input Voltage vs. WIDTH VR

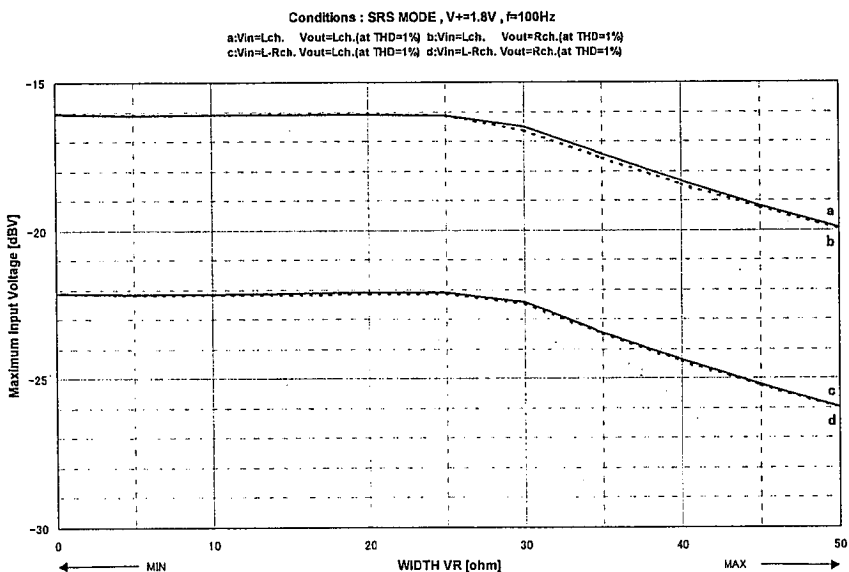

NJM2190

MEMO

[CAUTION]

The specifications on this databook are only given for information, without any guarantee as regards either mistakes or omissions. The application circuits in this databook are described only to show representative usages of the product and not intended for the guarantee or permission of any right including the industrial rights.