

> Features

- High Speed Switching
- Low On-Resistance
- No Secondary Breakdown
- Low Driving Power
- High Voltage
- $V_{GS} = \pm 30V$ Guarantee
- Avalanche Proof

> Applications

- Switching Regulators
- UPS
- DC-DC converters
- General Purpose Power Amplifier

> Outline Drawing

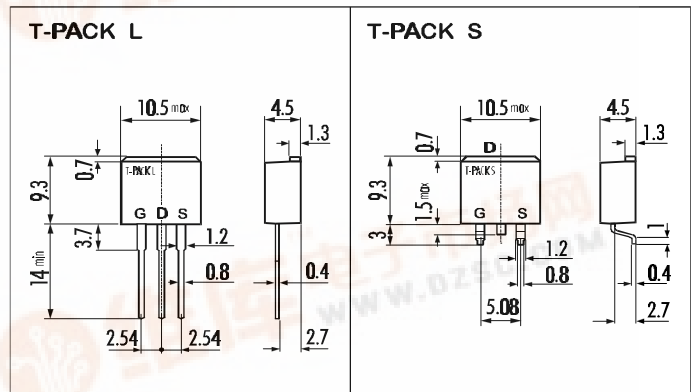

> Maximum Ratings and Characteristics

- Absolute Maximum Ratings ($T_C=25^\circ C$), unless otherwise specified

Item	Symbol	Rating	Unit
Drain-Source-Voltage	V_{DS}	900	V
Drain-Gate-Voltage ($R_{GS}=20K\Omega$)	V_{DGR}	900	V
Continous Drain Current	I_D	5	A
Pulsed Drain Current	$I_{D(puls)}$	20	A
Gate-Source-Voltage	V_{GS}	± 30	V
Max. Power Dissipation	P_D	80	W
Operating and Storage Temperature Range	T_{ch}	150	$^\circ C$
	T_{stg}	-55 ~ +150	$^\circ C$

> Equivalent Circuit

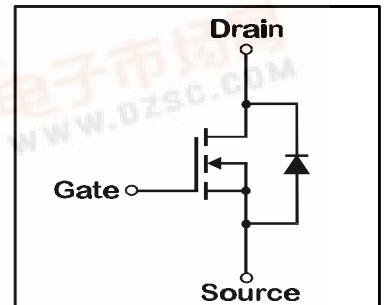

- Electrical Characteristics ($T_C=25^\circ C$), unless otherwise specified

Item	Symbol	Test conditions	Min.	Typ.	Max.	Unit
Drain-Source Breakdown-Voltage	$V_{(BR)DSS}$	$I_D=1mA$ $V_{GS}=0V$	900			V
Gate Threshold Voltage	$V_{GS(th)}$	$I_D=1mA$ $V_{DS}=V_{GS}$	2,5	3,0	3,5	V
Zero Gate Voltage Drain Current	I_{DSS}	$V_{DS}=900V$ $T_{ch}=25^\circ C$		10	500	μA
		$V_{GS}=0V$ $T_{ch}=125^\circ C$		0,2	1,0	mA
Gate Source Leakage Current	I_{GSS}	$V_{GS}=\pm 30V$ $V_{DS}=0V$		10	100	nA
Drain Source On-State Resistance	$R_{DS(on)}$	$I_D=2,5A$ $V_{GS}=10V$		2,0	2,8	Ω
Forward Transconductance	g_{fs}	$I_D=2,5A$ $V_{DS}=25V$	3	6		S
Input Capacitance	C_{iss}	$V_{DS}=25V$		1200	1800	pF
Output Capacitance	C_{oss}	$V_{GS}=0V$		120	180	pF
Reverse Transfer Capacitance	C_{rss}	$f=1MHz$		40	60	pF
Turn-On-Time t_{on} ($t_{on}=t_{d(on)}+t_r$)	$t_{d(on)}$	$V_{CC}=600V$		25	40	ns
	t_r	$I_D=5A$		25	40	ns
Turn-Off-Time t_{off} ($t_{off}=t_{d(off)}+t_f$)	$t_{d(off)}$	$V_{GS}=10V$		85	130	ns
	t_f	$R_{GS}=10\Omega$		45	70	ns
Avalanche Capability	I_{AV}	$L=100\mu H$ $T_{ch}=25^\circ C$	5			A
Continous Reverse Drain Current	I_{DR}				5	A
Pulsed Reverse Drain Current	I_{DRM}				20	A
Diode Forward On-Voltage	V_{SD}	$I_F=2I_{DR}$ $V_{GS}=0V$ $T_{ch}=25^\circ C$		0,93	1,4	V
Reverse Recovery Time	t_{rr}	$I_F=I_{DR}$ $V_{GS}=0V$		400		ns
Reverse Recovery Charge	Q_{rr}	$-dI_F/dt=100A/\mu s$ $T_{ch}=25^\circ C$		1,5		μC

- Thermal Characteristics

Item	Symbol	Test conditions	Min.	Typ.	Max.	Unit
Thermal Resistance	$R_{th(ch-a)}$	channel to air			125	$^\circ C/W$
	$R_{th(ch-c)}$	channel to case			1,56	$^\circ C/W$

N-channel MOS-FET			
900V	2,8Ω	5A	80W

2SK1945-01L,S

FAP-IIA Series



> Characteristics

Typical Output Characteristics

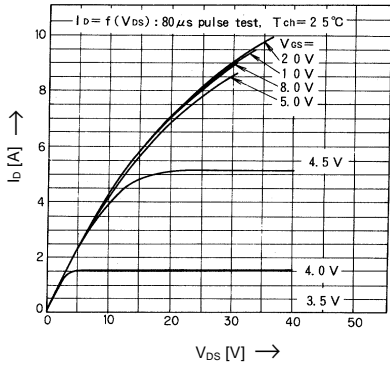

Drain-Source-On-State Resistance vs. Tch

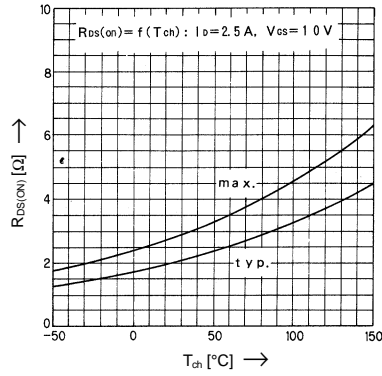

Typical Transfer Characteristics

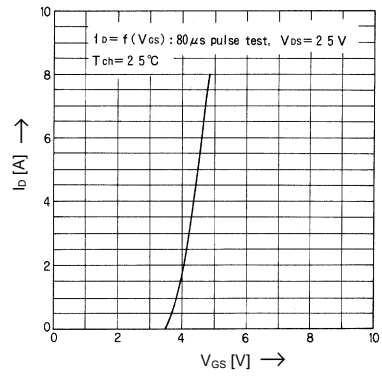

Typical Drain-Source-On-State-Resistance vs. Id

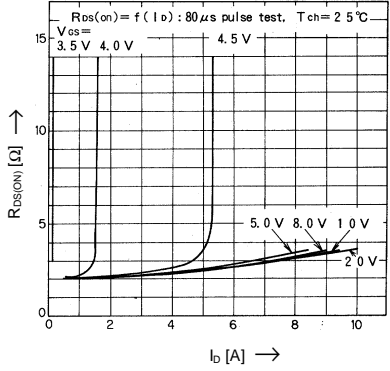

Typical Forward Transconductance vs. Id

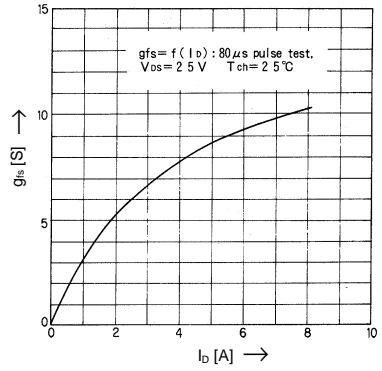

Gate Threshold Voltage vs. Tch

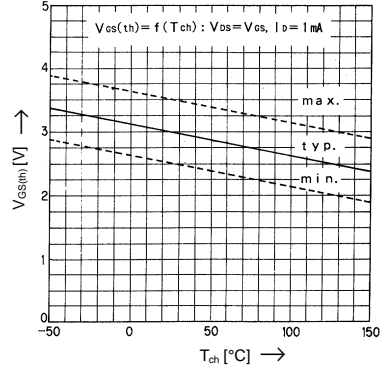

Typical Capacitance vs. Vds

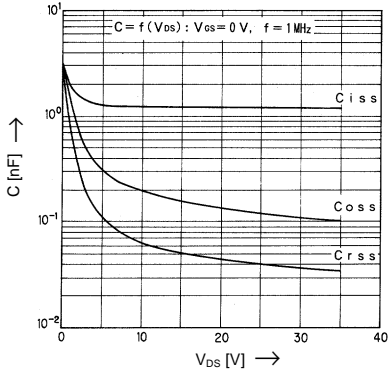

Typical Input Charge

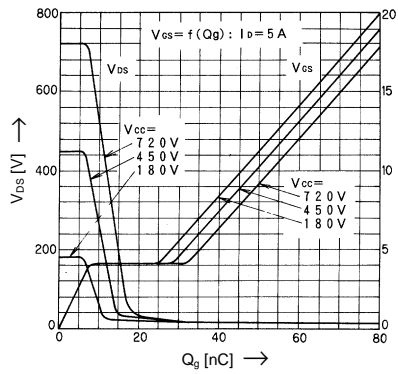

Forward Characteristics of Reverse Diode

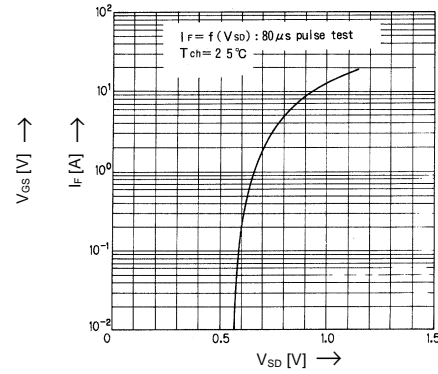

Allowable Power Dissipation vs. Tch

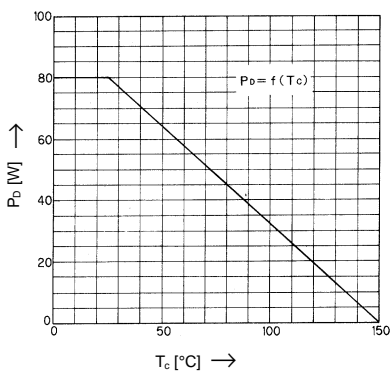

Safe operation area

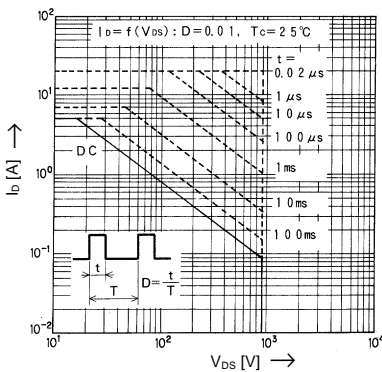

Transient Thermal impedance

