

2SK3521-01L,S,SJ



FUJI POWER MOSFET Super FAP-G Series

N-CHANNEL SILICON POWER MOSFET

Features

- High speed switching
- Low on-resistance
- No secondary breakdown
- Low driving power
- Avalanche-proof

Applications

- Switching regulators
- UPS (Uninterruptible Power Supply)
- DC-DC converters

Maximum ratings and characteristic Absolute maximum ratings

(Tc=25°C unless otherwise specified)

Item	Symbol	Ratings	Unit
Drain-source voltage	V _{DS}	500	V
Continuous drain current	I _D	±8	A
Pulsed drain current	I _{D(puls)}	±32	A
Gate-source voltage	V _{GS}	±30	V
Repetitive or non-repetitive	I _{AR} *2	8	A
Maximum Avalanche Energy	E _{AS} *1	173	mJ
Maximum Drain-Source dV/dt	dV _{DS} /dt *4	20	kV/μs
Peak Diode Recovery dV/dt	dV/dt *3	5	kV/μs
Max. power dissipation	P _D	T _a =25°C	1.67
		T _c =25°C	65
Operating and storage temperature range	T _{ch}	+150	°C
	T _{stg}	-55 to +150	°C

*1 L=4.98mH, V_{CC}=50V *2 T_{ch}≤150°C *3 I_F≤-I_D, -di/dt=50A/μs, V_{CC}≤BV_{DSS}, T_{ch}≤150°C

*4 V_{DS}≤500V

Electrical characteristics (Tc=25°C unless otherwise specified)

Item	Symbol	Test Conditions	Min.	Typ.	Max.	Units
Drain-source breakdown voltage	V(BR) _{DSS}	I _D =250μA V _{GS} =0V	500			V
Gate threshold voltage	V _{GS(th)}	I _D =250μA V _{DS} =V _{GS}	3.0		5.0	V
Zero gate voltage drain current	I _{DSS}	V _{DS} =500V V _{GS} =0V			25	μA
		V _{DS} =400V V _{GS} =0V			250	
Gate-source leakage current	I _{GSS}	V _{GS} =±30V V _{DS} =0V		10	100	nA
Drain-source on-state resistance	R _{DS(on)}	I _D =4A V _{GS} =10V		0.65	0.85	Ω
Forward transconductance	g _{fs}	I _D =4A V _{DS} =25V	3.5	7		S
Input capacitance	C _{iss}	V _{DS} =25V		750	1130	pF
Output capacitance	C _{oss}	V _{GS} =0V		100	150	
Reverse transfer capacitance	C _{rss}	f=1MHz		4.0	6.0	ns
Turn-on time t _{on}	td(on)	V _{CC} =300V I _D =4A		14	21	
	t _r	V _{GS} =10V		9	14	
Turn-off time t _{off}	td(off)	R _{GS} =10 Ω		24	36	
	t _f			6	9	
Total Gate Charge	Q _G	V _{CC} =250V		20	30	nC
Gate-Source Charge	Q _{GS}	I _D =8A		8.5	13	
Gate-Drain Charge	Q _{GD}	V _{GS} =10V		5.5	8.5	
Avalanche capability	I _{AV}	L=4.98mH T _{ch} =25°C	8			A
Diode forward on-voltage	V _{SD}	I _F =8A V _{GS} =0V T _{ch} =25°C		1.00	1.50	V
Reverse recovery time	t _{rr}	I _F =8A V _{GS} =0V		0.65		μs
Reverse recovery charge	Q _{rr}	-di/dt=100A/μs T _{ch} =25°C		3.5		μC

Outline Drawings



Equivalent circuit schematic

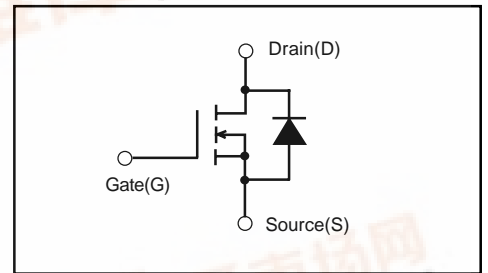

Thermal characteristics

Item	Symbol	Test Conditions	Min.	Typ.	Max.	Units
Thermal resistance	R _{th(ch-c)}	channel to case			1.92	°C/W

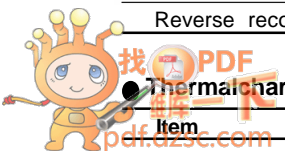

Characteristics

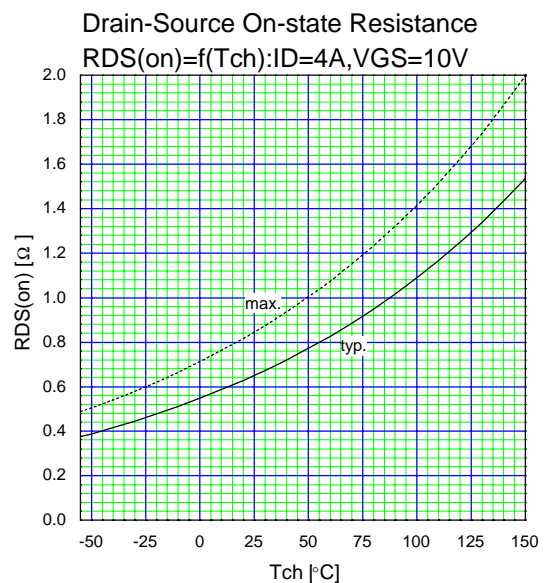
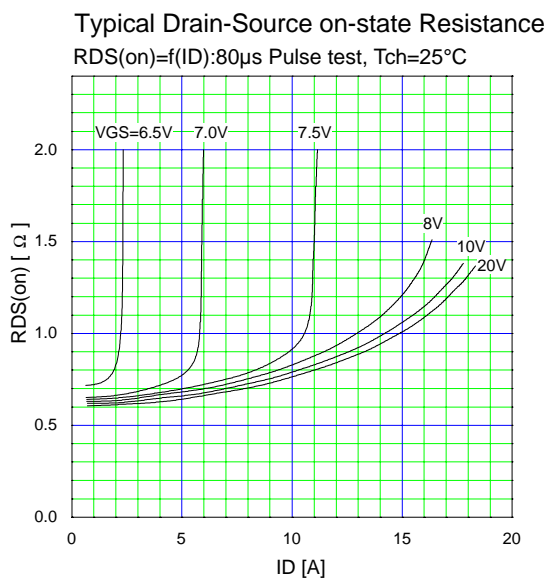
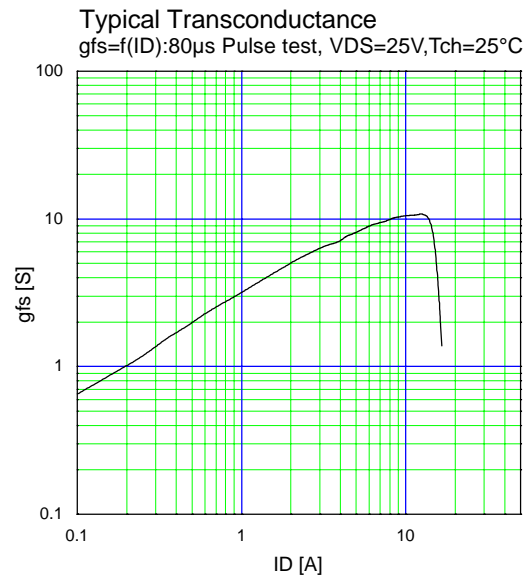
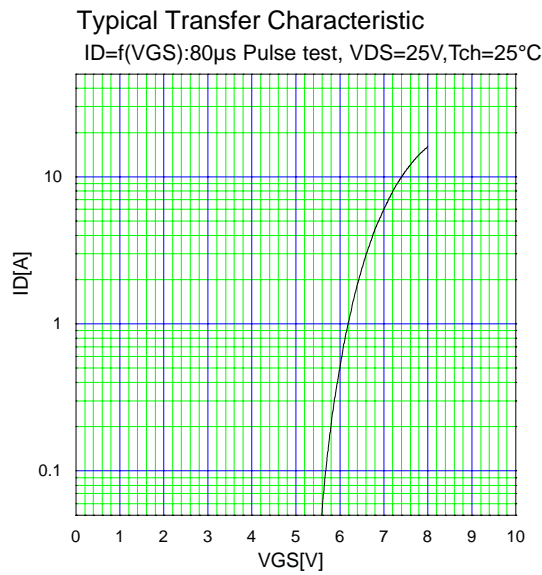
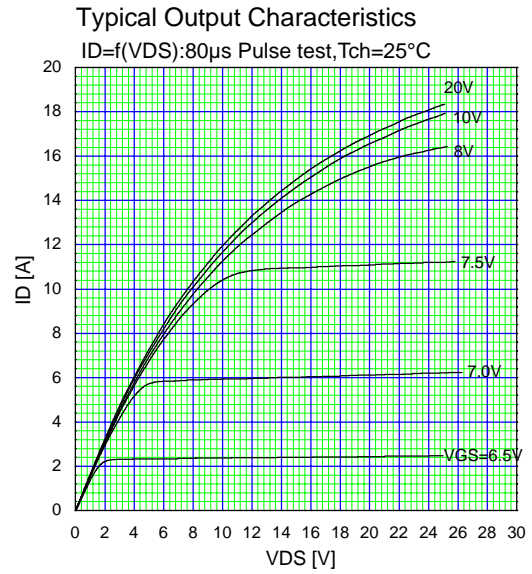
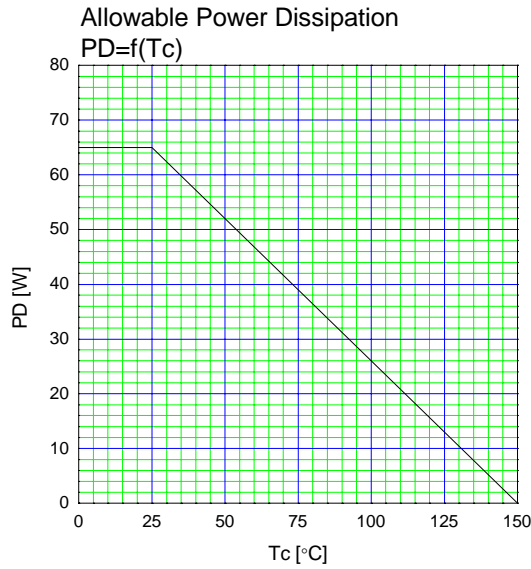

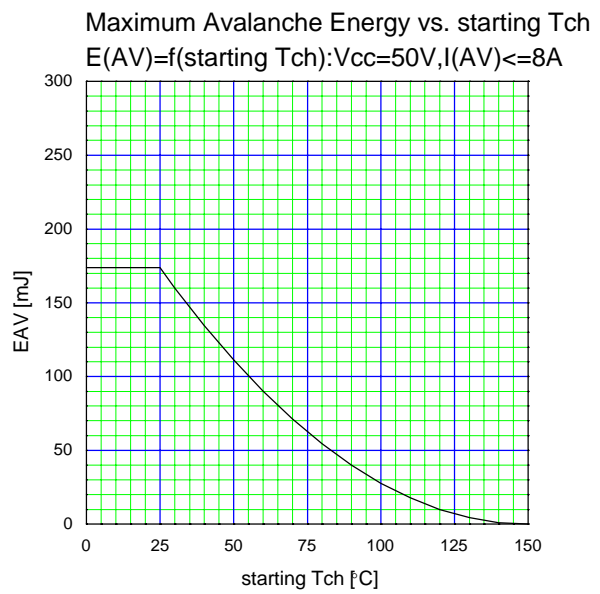
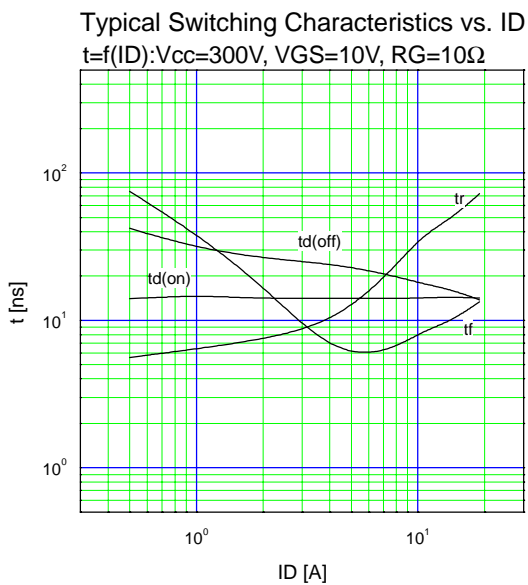
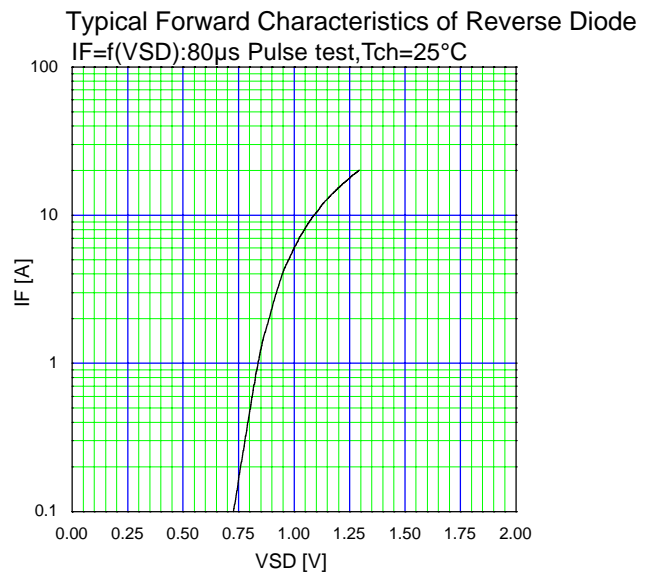
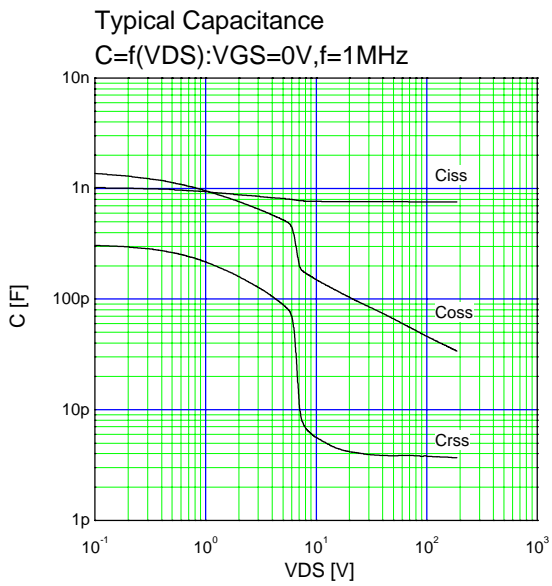
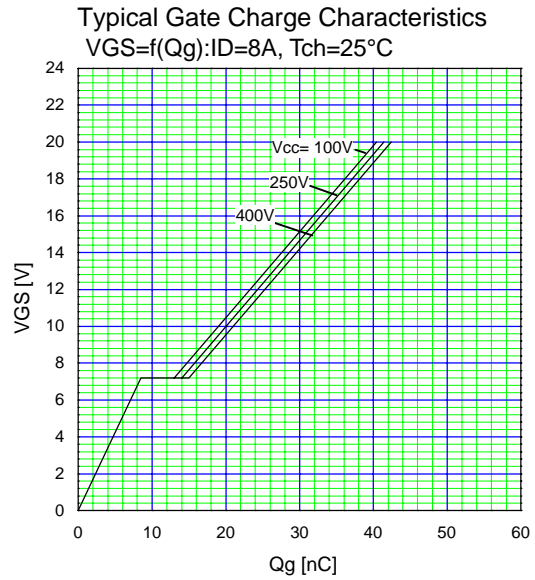
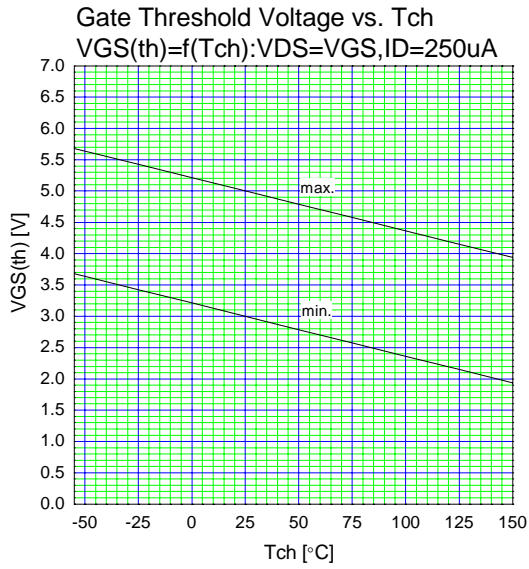

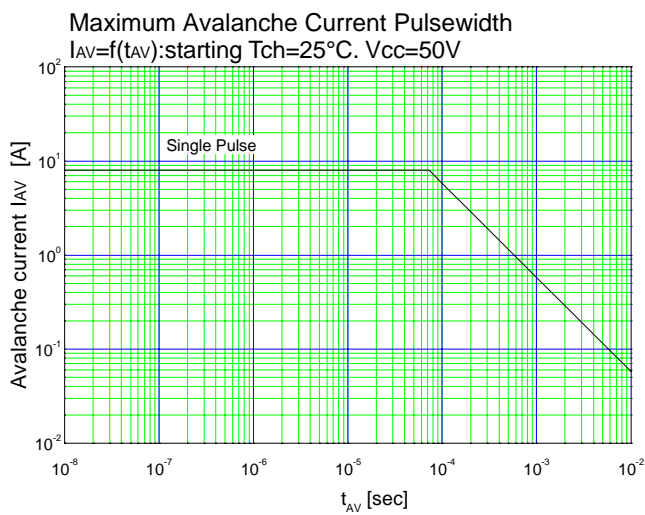
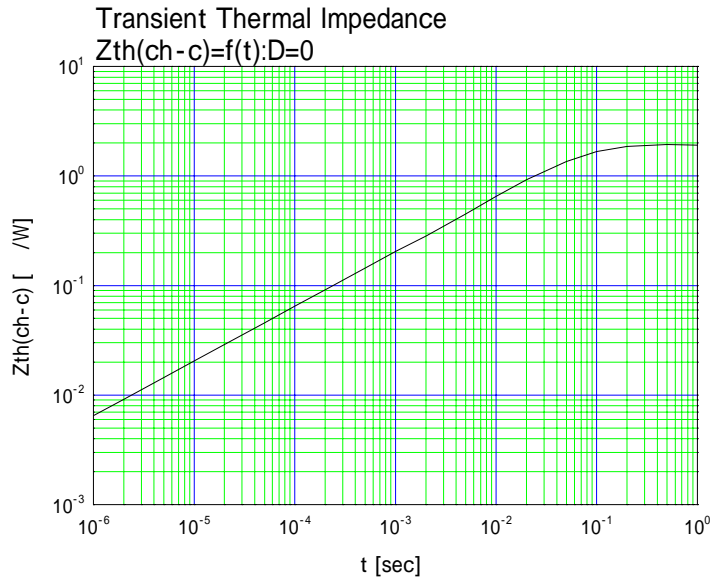

■ Outline Drawings (mm)

Type(L)

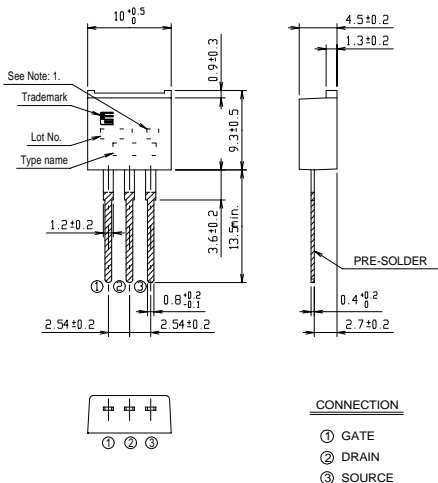

Type(S)

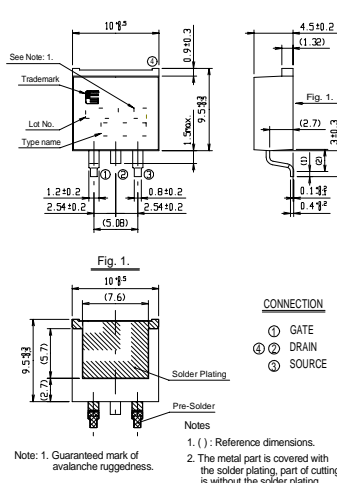

Type(SJ)

