

**cosmo**

**High Reliability Digital Output IC  
Photo IC Photo Coupler**

**KP7110**

UL 1577 (File No.E169586)

**Features**

1. High sensitivity.
2. TTL and LSTTL compatible output.
3. Operating supply voltage range.  
(Vcc 4.5V to 17V)
4. Output form pull-up resistor built-in type.
5. Low output current dissipation.  
(IcCL : MAX. 3.8mA)
6. High isolation voltage between input and output  
(Viso : 5000Vrms).
7. Available package : DIP/ SMD/ H. (For Package Dimension please refer to page 82 )

**Applications**

1. Computer terminals.
2. High speed line receivers.
3. Interfaces with various data transmission equipment.
4. Switching regulators.

**Outside Dimension : Unit (mm)**

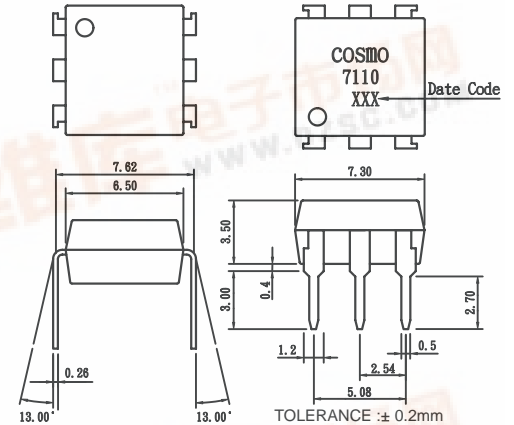

**Schematic : Top View**

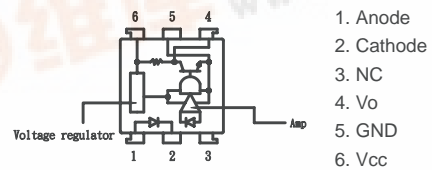

**Absolute Maximum Ratings**

(Ta=25°C)

Parameter		Symbol	Rating	Unit
Input	Forward current	IF	50	mA
	Peak forward current	IFM	1	A
	Reverse voltage	VR	6	V
	Power dissipation	PD	70	mW
Output	Supply voltage	VCC	-0.5+0.17	A
	Output current	IO	50	A
	Power dissipation	PD	150	mW
Total power dissipation		Ptot	170	mW
Isolation voltage 1 minute		Viso	5000	Vrms
Operating temperature		Topr	-25 to +85	°C
Storage temperature		Tstg	-40 to +125	°C
Soldering temperature		Tsol	260	°C

**Electro-optical Characteristics**

(Ta=25°C)

Parameter		Symbol	Conditions	MIN.	TYP.	MAX.	Unit
Input	Forward voltage	VF	IF=10mA	—	1.2	1.4	V
	Peak forward voltage	VFM	IFM=0.5A	—	—	3.5	V
	Reverse current	IR	VR=4V	—	—	10	uA
	Terminal capacitance	Ct	V=0, f=1kHz	—	30	—	pF
Output	Operating supply voltage	VCC		4.5	—	17	V
	Low level output voltage	VOL	IOL=16mA, VCC=5V, IF=4mA	—	0.15	0.4	V
	High level output voltage	VOH	VCC=5V, IF=0	3.5	—	—	V
	Low level supply current	ICCL	VCC=5V, IF=1mA	—	1.7	3.8	mA
	High level supply current	ICCH	VCC=5V, IF=0	—	0.7	2.2	mA
Transfer characteristics	"High-Low" Threshold input current	IFHL	VCC=5V, RL=280ohm	—	0.5	1.0	mA
	"Low-High" Threshold input current	IFLH	VCC=5V, RL=280ohm	0.1	0.4	—	mA
	Hysteresis	IFLH /IFHL	VCC=5V, RL=280ohm	—	0.8	—	—
	Isolation resistance	Riso	Ta=25°C, DC500V	5x10 <sup>10</sup>	10 <sup>11</sup>	—	ohm
	Response time	"High-Low" propagation delay time	tPHL	Ta=25°C, VCC=5V, IF=1mA, RL=280ohm	—	3	9
"Low-High" propagation delay time		tPLH	—		5	15	
Fall time		tf	—		0.05	0.5	
Rise time		tr	—		0.1	0.5	



**Fig.1** Low Level Output Current vs. Ambient Temperature

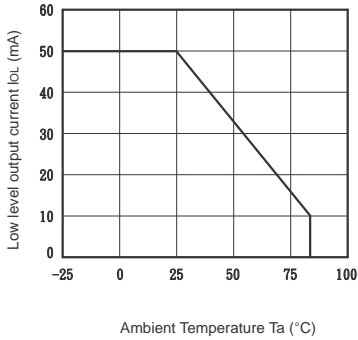

**Fig.2** Power Dissipation vs. Ambient Temperature

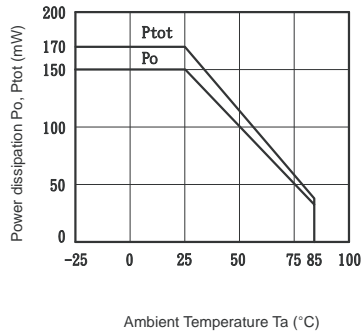

**Fig.3** Rise Time, Fall Time vs. Load Resistance

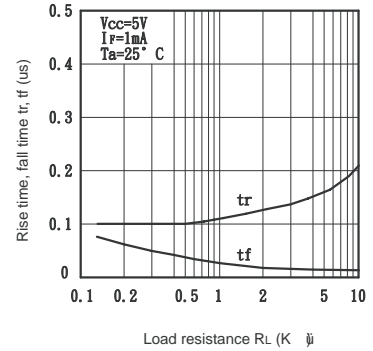

**Fig.4** Forward Current vs. Forward Voltage

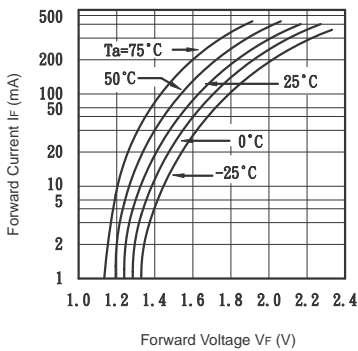

**Fig.5** Supply Current vs. Ambient Temperature

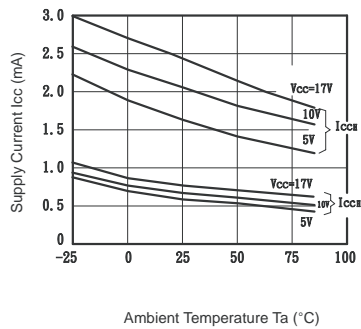

**Fig.6** Low Level Output Voltage vs. Ambient Temperature

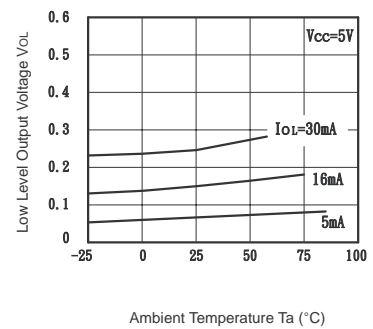

**Fig.7** Propagation Delay Time vs. Forward Current

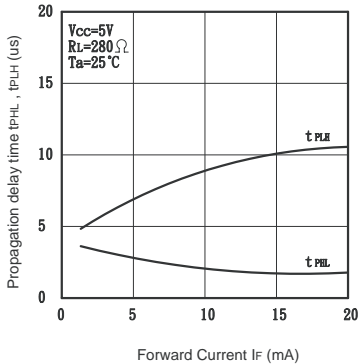

**Fig.8** Low Level Output Voltage vs. Low Level Output Current

