

SWITCHING APPLICATION.
INTERFACE CIRCUIT AND DRIVER CIRCUIT APPLICATION.

FEATURES

- With Built-in Bias Resistors.
- Simplify Circuit Design.
- Reduce a Quantity of Parts and Manufacturing Process.

EQUIVALENT CIRCUIT

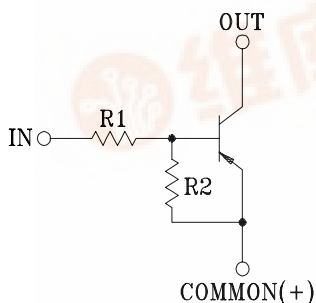

BIAS RESISTOR VALUES

TYPE NO.	R1(kΩ)	R2(kΩ)
KRA101S	4.7	4.7
KRA102S	10	10
KRA103S	22	22
KRA104S	47	47
KRA105S	2.2	47
KRA106S	4.7	47

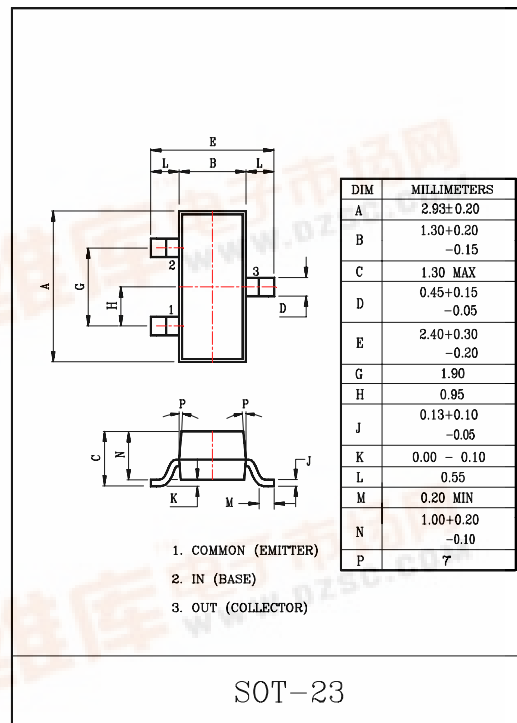

MAXIMUM RATINGS (Ta=25°C)

CHARACTERISTIC		SYMBOL	RATING	UNIT
Output Voltage	KRA101S~106S	V _o	-50	V
Input Voltage	KRA101S	V _i	-20, 10	V
	KRA102S		-30, 10	
	KRA103S		-40, 10	
	KRA104S		-40, 10	
	KRA105S		-12, 5	
	KRA106S		-20, 5	
Output Current	KRA101S~106S	I _o	-100	mA
Power Dissipation		P _D	200	mW
Junction Temperature		T _j	150	°C
Storage Temperature Range		T _{stg}	-55~150	°C

MARK SPEC

TYPE	KRA101S	KRA102S	KRA103S	KRA104S	KRA105S	KRA106S
MARK	PDPA	PB	PC	PD	PE	PF

Marking

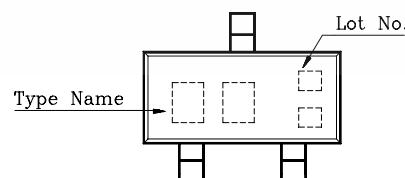

KRA101S ~ KRA106S

ELECTRICAL CHARACTERISTICS (Ta=25°C)

CHARACTERISTIC		SYMBOL	TEST CONDITION	MIN.	TYP.	MAX.	UNIT
Output Cut-off Current	KRA101S~106S	$I_{O(OFF)}$	$V_O=-50V, V_I=0$	-	-	-500	nA
DC Current Gain	KRA101S	G_I	$V_O=-5V, I_O=-10mA$	30	55	-	
	KRA102S			50	80	-	
	KRA103S			70	120	-	
	KRA104S			80	200	-	
	KRA105S			80	200	-	
	KRA106S			80	200	-	
Output Voltage	KRA101S~106S	$V_{O(ON)}$	$I_O=-10mA, I_I=-0.5mA$	-	-0.1	-0.3	V
Input Voltage (ON)	KRA101S	$V_{I(ON)}$	$V_O=-0.2V, I_O=-5mA$	-	-1.5	-2.0	V
	KRA102S			-	-1.8	-2.4	
	KRA103S			-	-2.1	-3.0	
	KRA104S			-	-2.8	-5.0	
	KRA105S			-	-0.8	-1.1	
	KRA106S			-	-0.9	-1.3	
Input Voltage (OFF)	KRA101S~104S	$V_{I(OFF)}$	$V_O=-5V, I_O=-0.1mA$	-1.0	-1.2	-	V
	KRA105S~106S			-0.5	-0.65	-	
Transition Frequency	KRA101S~106S	$f_T *$	$V_O=-10V, I_O=-5mA$	-	200	-	MHz
Input Current	KRA101S	I_I	$V_I=-5V$	-	-	-1.8	mA
	KRA102S			-	-	-0.88	
	KRA103S			-	-	-0.36	
	KRA104S			-	-	-0.18	
	KRA105S			-	-	-3.6	
	KRA106S			-	-	-1.8	

Note : *Characteristic of Transistor Only

KRA101S ~ KRA106S

ELECTRICAL CHARACTERISTICS (Ta=25°C)

CHARACTERISTIC		SYMBOL	TEST CONDITION	MIN.	TYP.	MAX.	UNIT	
Switching Time	Rise Time	KRA101S	V _O =-5V V _{IN} =-5V R _L =1kΩ	-	0.07	-	μS	
		KRA102S		-	0.06	-		
		KRA103S		-	0.2	-		
		KRA104S		-	0.24	-		
		KRA105S		-	0.02	-		
		KRA106S		-	0.07	-		
	Storage Time	KRA101S		t _{stg}	-	1.1		-
		KRA102S		-	1.1	-		
		KRA103S		-	1.1	-		
		KRA104S		-	1.1	-		
		KRA105S		-	1.1	-		
		KRA106S		-	1.1	-		
	Fall Time	KRA101S		t _f	-	0.15		-
		KRA102S		-	0.24	-		
		KRA103S		-	0.38	-		
		KRA104S		-	0.63	-		
		KRA105S		-	0.1	-		
		KRA106S		-	0.2	-		

KRA101S ~ KRA106S

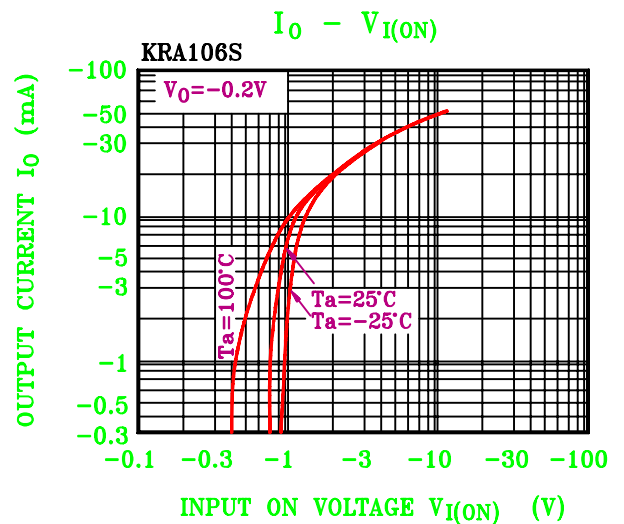
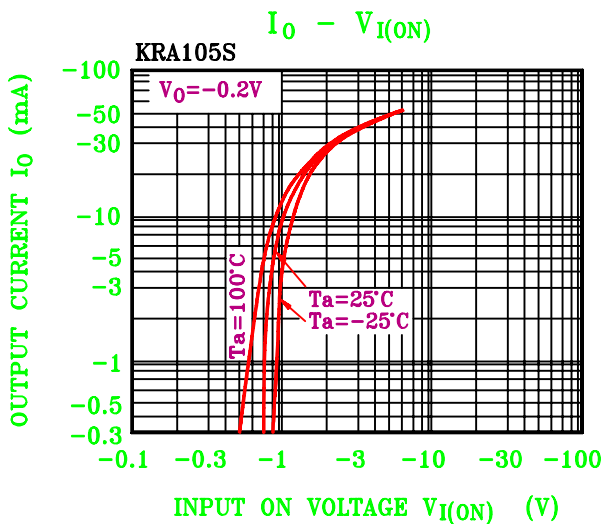
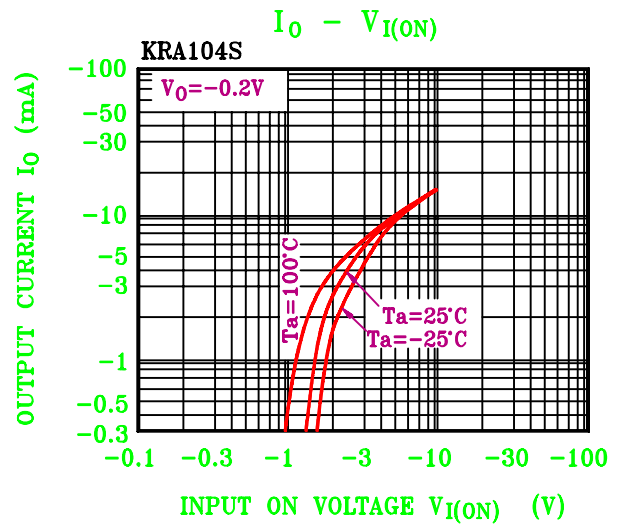
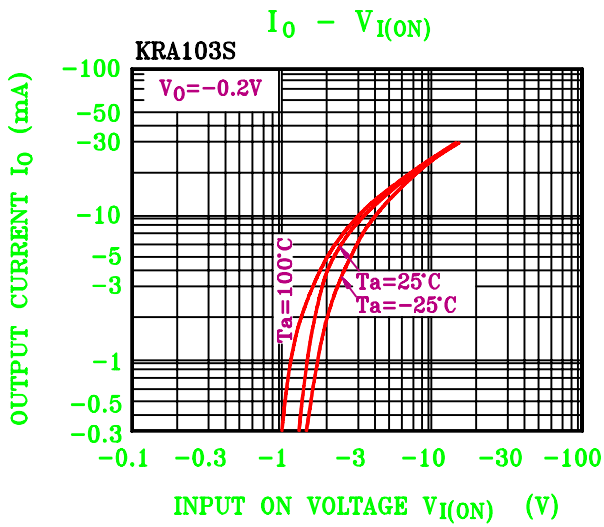
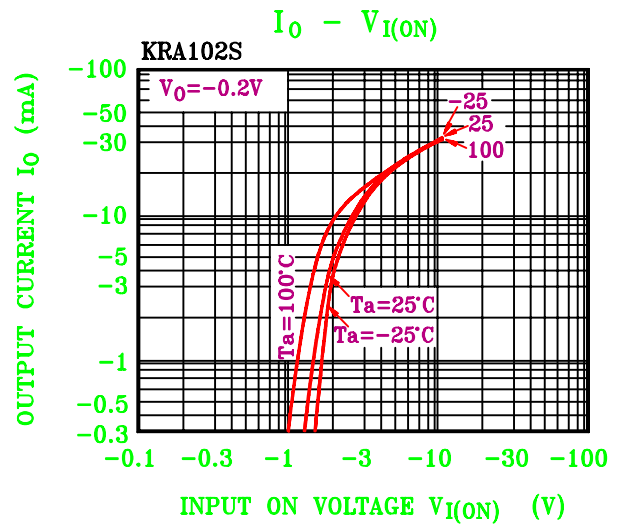
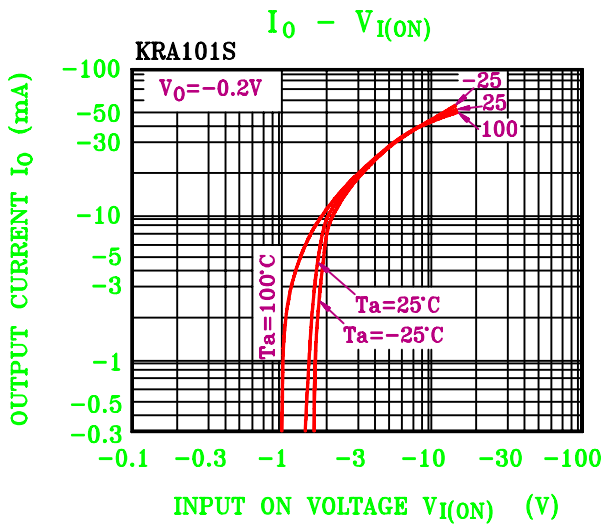

KRA101S ~ KRA106S

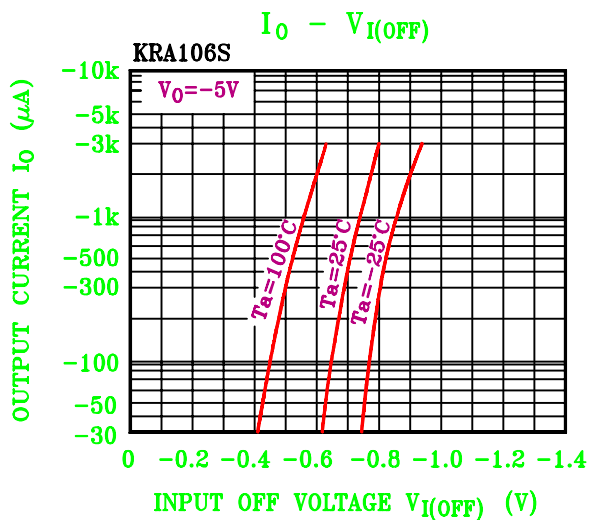
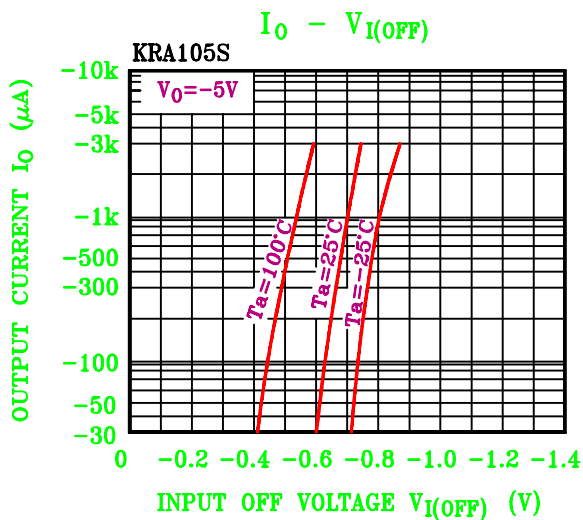
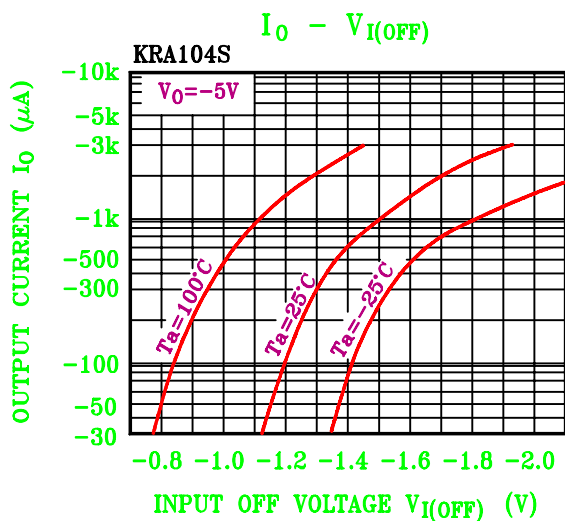
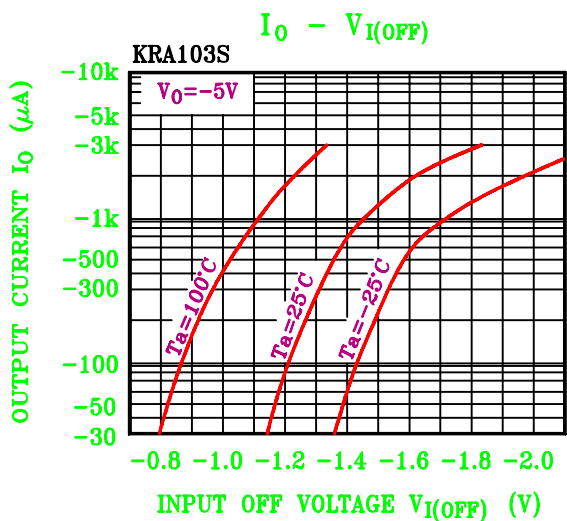
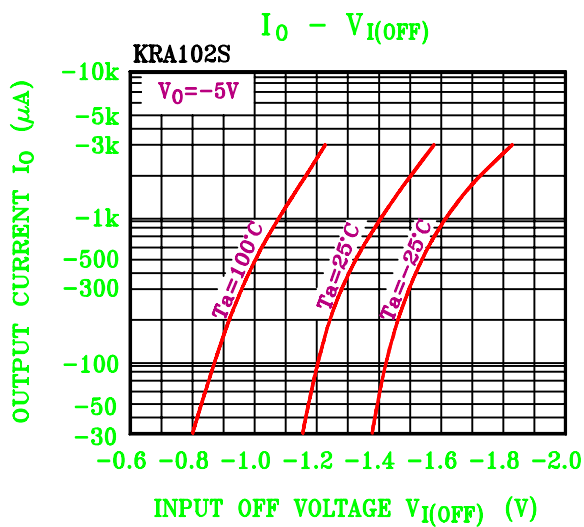
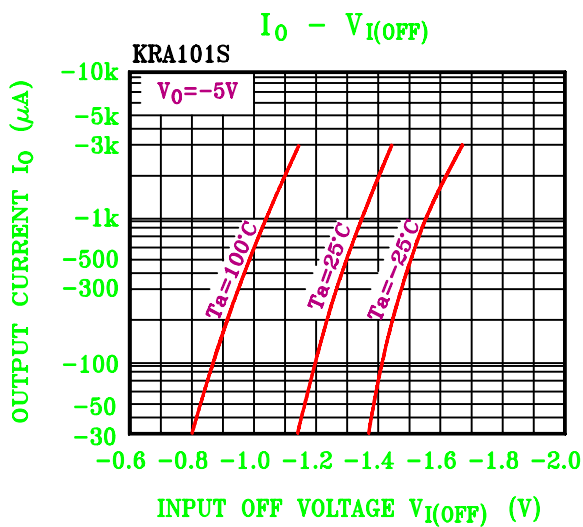

KRA101S ~ KRA106S

