

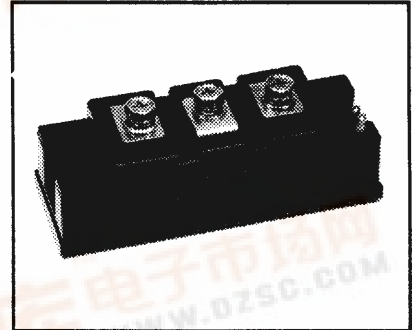

KS224510

Powerex, Inc., 200 Hillis Street, Youngwood, Pennsylvania 15697-1800 (412) 925-7272

Single Darlington Transistor Module 100 Amperes/600 Volts

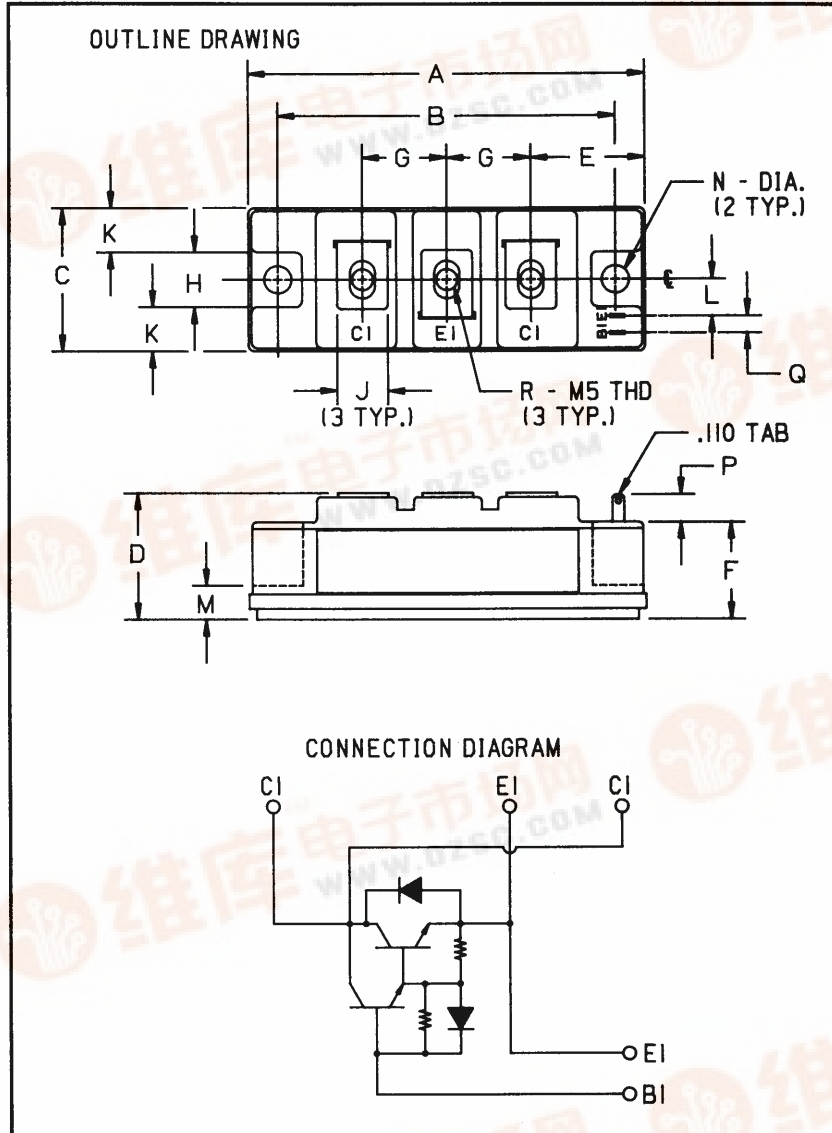

Description:

The Powerex Single Darlington Transistor Modules are high power devices designed for use in switching applications. The modules are isolated, consisting of one Darlington Transistor with a reverse parallel connected high-speed diode and base-to-emitter speed-up diode.

Features:

- Isolated Mounting
- Planar Chips
- Discrete Fast Recovery Feedback Diode
- High Gain (h_{FE})
- TAB Quick-Connect Terminals
- Base-Emitter Speed-up Diode

Applications:

- Inverters
- DC Motor Control
- Switching Power Supplies
- AC Motor Control

Outline Drawing

Dimensions	Inches	Millimeters
A	3.701 Max.	94 Max.
B	3.150 ± 0.010	80 ± 0.25
C	1.339 Max.	34 Max.
D	1.181 Max.	30 Max.
E	1.063	27
F	0.906	23
G	0.787	20
H	0.512	13

Dimensions	Inches	Millimeters
J	0.472	12
K	0.413	10.5
L	0.344	8.75
M	0.315	8
N	0.256 Dia.	6.5 Dia.
P	0.256 Min.	6.5 Min.
Q	0.157	4
R	M5 Metric	M5

Ordering Information:

Example: Select the complete eight digit module part number you desire from the table - i.e. KS224510 is a 450 $V_{CE0(sus)}$ (600 V_{CEV}), 100 Ampere Single Darlington Module.

Type	$V_{CE0(sus)}$ Volts (X 10)	Current Rating Amperes (X 10)
KS22	45	10



Powerex, Inc., 200 Hillis Street, Youngwood, Pennsylvania 15697-1800 (412) 925-7272

KS224510
Single Darlingon Transistor Module
 100 Amperes/600 Volts

Absolute Maximum Ratings, $T_J = 25^\circ\text{C}$ unless otherwise specified

Ratings	Symbol	KS224510	Units
Junction Temperature	T_J	-40 to 150	$^\circ\text{C}$
Storage Temperature	T_{stg}	-40 to 125	$^\circ\text{C}$
Collector-Emitter Sustaining Voltage	$V_{CE(sus)}$	450	Volts
Collector-Emitter Sustaining Voltage, $V_{BE} = -2\text{V}$	$V_{CEV(sus)}$	600	Volts
Collector-Base Voltage	V_{CBO}	600	Volts
Emitter-Base Voltage	V_{EBO}	7	Volts
Collector-Emitter Voltage	V_{CEV}	600	Volts
Continuous Collector Current	I_C	100	Amperes
Diode Forward Current	I_{FM}	100	Amperes
Continuous Base Current	I_B	6	Amperes
Diode Surge Current	I_{FSM}	1000	Amperes
Power Dissipation	P_T	620	Watts
Max. Mounting Torque M5 Terminal Screws	-	17	in.-lb.
Max. Mounting Torque M6 Mounting Screws	-	17	in.-lb.
Module Weight (Typical)	-	250	Grams
V Isolation	V_{RMS}	2000	Volts

Electrical Characteristics, $T_J = 25^\circ\text{C}$ unless otherwise specified

Characteristics	Symbol	Test Conditions	Min.	Typ.	Max.	Units
Collector Cutoff Current	I_{CEV}	$V_{CE} = 600\text{V}, V_{BE} = -2\text{V}$ $V_{CE} = 600\text{V}, V_{BE} = -2\text{V}, T_C = 125^\circ\text{C}$	-	-	2	mA
Emitter Cutoff Current	I_{EBO}	$V_{EB} = 7\text{V}$	-	-	400	mA
DC Current Gain	h_{FE}	$I_C = 100\text{A}, V_{CE} = 2\text{V}$ $I_C = 100\text{A}, V_{CE} = 5\text{V}$	75	-	-	-
Diode Forward Voltage	V_{FM}	$I_{FM} = 100\text{A}$	-	-	1.75	Volts
Collector-Emitter Saturation Voltage	$V_{CE(sat)}$	$I_C = 100\text{A}, I_B = 1.3\text{A}$	-	-	2.0	Volts
Base-Emitter Saturation Voltage	$V_{BE(sat)}$	$I_C = 100\text{A}, I_B = 1.3\text{A}$	-	-	2.5	Volts
Resistive Turn-on	t_{on}	$V_{CC} = 300\text{V}$	-	-	2.0	μs
Load Storage Time	t_s	$I_C = 100\text{A}$	-	-	12	μs
Switch Times Fall Time	t_f	$I_{B1} = 2\text{A}, I_{B2} = -2\text{A}$	-	-	3.0	μs



Powerex, Inc., 200 Hillis Street, Youngwood, Pennsylvania 15697-1800 (412) 925-7272

KS224510
Single Darlington Transistor Module
 100 Amperes/600 Volts

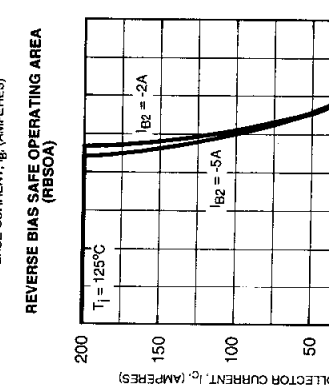
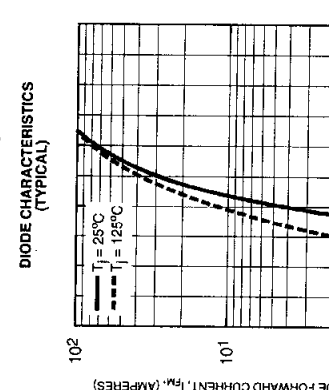
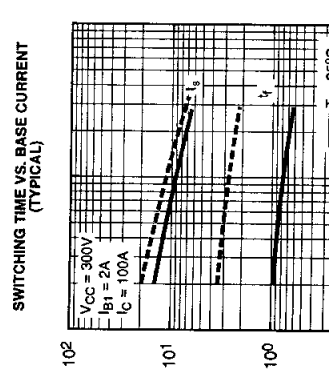
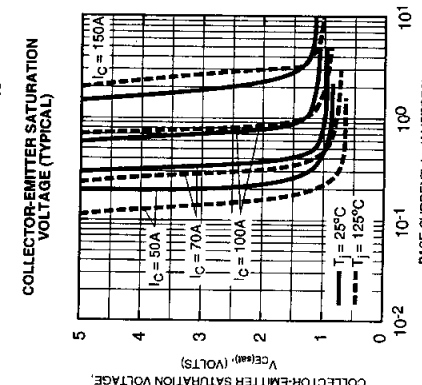
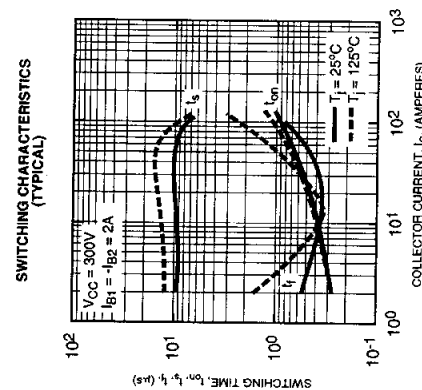
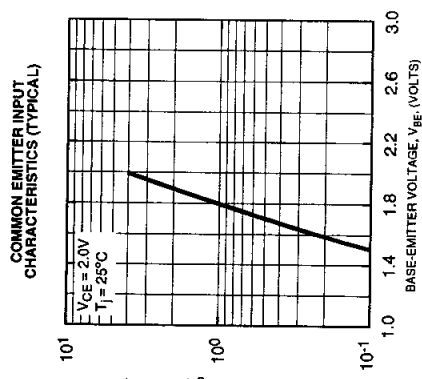
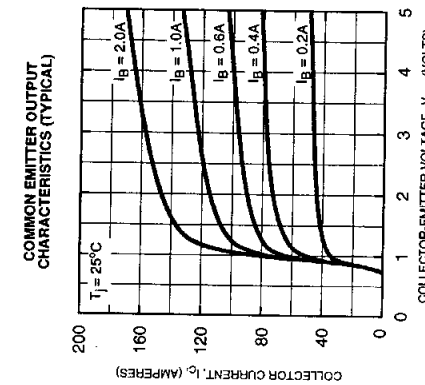
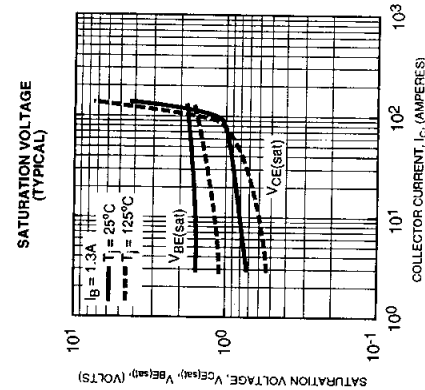
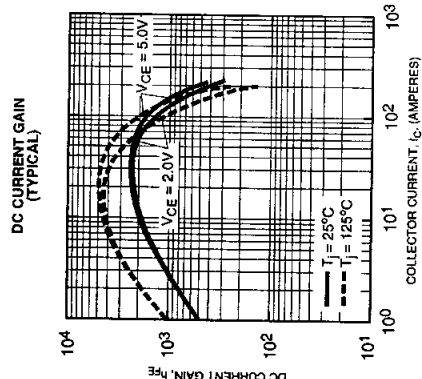



Powerex, Inc., 200 Hillis Street, Youngwood, Pennsylvania 15697-1800 (412) 925-7272

KS224510
Single Darlington Transistor Module
100 Amperes/600 Volts

