

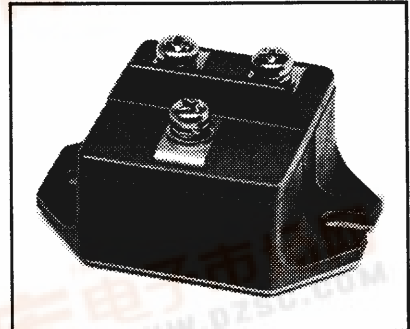

Powerex, Inc., 200 Hillis Street, Youngwood, Pennsylvania 15697-1800 (412) 925-7272

## KS524505

### Single Darlington Transistor Module 50 Amperes/600 Volts

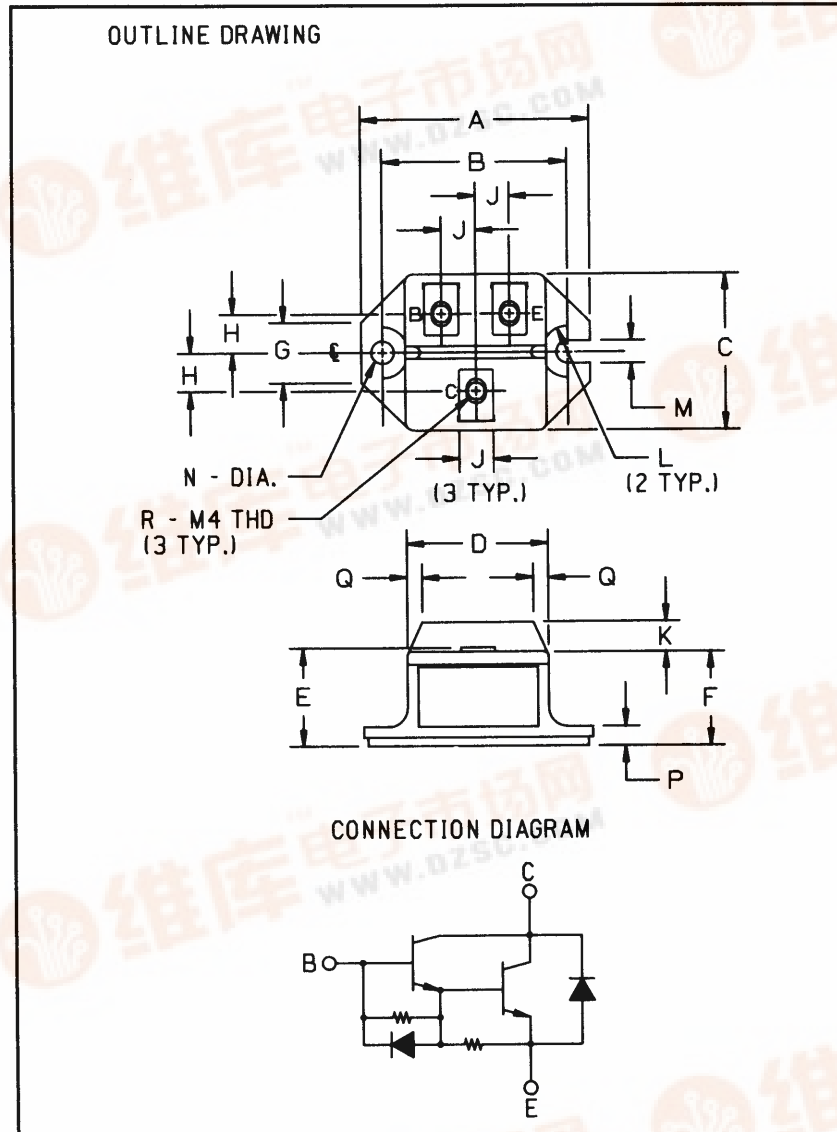

#### Description:

The Powerex Single Darlington Transistor Modules are high power devices designed for use in switching applications. The modules are isolated, consisting of one Darlington Transistor with a reverse parallel connected high-speed diode and base-to-emitter speed-up diode.

#### Features:

- Isolated Mounting
- Planar Chips
- Discrete Fast Recovery Feedback Diode
- High Gain ( $h_{FE}$ )
- Base-Emitter Speed-up Diode

#### Applications:

- Inverters
- DC Motor Control
- Switching Power Supplies
- AC Motor Control

#### Ordering Information:

Example: Select the complete eight digit module part number you desire from the table - i.e. KS524505 is a 450  $V_{CEO(sus)}$  (600  $V_{CEV}$ ), 50 Ampere Single Darlington Module.

Outline Drawing

Dimensions	Inches	Millimeters
A	2.106	53.5
B	1.705 ± 0.008	43.3 ± 0.02
C	1.437	36.5
D	1.299	33
E	0.925	23.5
F	0.866	22
G	0.551	14
H	0.354	9

Dimensions	Inches	Millimeters
J	0.315	8
K	0.276	7
L	0.236 Rad.	6 Rad.
M	0.209	5.3
N	0.209 Dia.	5.3 Dia.
P	0.177	4.5
Q	0.138	3.5
R	M4 Metric	M4

Type	$V_{CEO(sus)}$ Volts (X 10)	Current Rating Amperes (x 10)
KS52	45	05





Powerex, Inc., 200 Hillis Street, Youngwood, Pennsylvania 15697-1600 (412) 925-7272

**KSS24505**  
Single Darlington Transistor Module  
50 Amperes/600 Volts

**Absolute Maximum Ratings,  $T_J = 25^\circ\text{C}$  unless otherwise specified**

Ratings	Symbol	KSS24505	Units
Junction Temperature	$T_J$	-40 to 150	$^\circ\text{C}$
Storage Temperature	$T_{\text{sig}}$	-40 to 125	$^\circ\text{C}$
Collector-Emitter Sustaining Voltage	$V_{\text{CEO(sus)}}$	450	Volts
Collector-Emitter Sustaining Voltage, $V_{\text{BE}} = -2\text{V}$	$V_{\text{CEV(sus)}}$	600	Volts
Collector-Base Voltage	$V_{\text{CBO}}$	600	Volts
Emitter-Base Voltage	$V_{\text{EBO}}$	7	Volts
Collector-Emitter Voltage	$V_{\text{CEV}}$	600	Volts
Continuous Collector Current	$I_C$	50	Amperes
Diode Forward Current	$I_{\text{FM}}$	50	Amperes
Continuous Base Current	$I_B$	3	Amperes
Diode Surge Current	$I_{\text{FSM}}$	500	Amperes
Power Dissipation	$P_T$	310	Watts
Max. Mounting Torque M5 Terminal Screws	-	17	in.-lb.
Max. Mounting Torque M6 Mounting Screws	-	26	in.-lb.
Module Weight (Typical)	-	90	Grams
V Isolation	$V_{\text{RMS}}$	2000	Volts

**Electrical Characteristics,  $T_J = 25^\circ\text{C}$  unless otherwise specified**

Characteristics	Symbol	Test Conditions	Min.	Typ.	Max.	Units
Collector Cutoff Current	$I_{\text{CEV}}$	$V_{\text{CE}} = 600\text{V}, V_{\text{BE}} = -2\text{V}$	-	-	1	mA
Emitter Cutoff Current	$I_{\text{EBO}}$	$V_{\text{CE}} = 600\text{V}, V_{\text{BE}} = -2\text{V}, T_C = 125^\circ\text{C}$	-	-	5	mA
		$V_{\text{EB}} = 7\text{V}$	-	-	200	mA
DC Current Gain	$h_{\text{FE}}$	$I_C = 50\text{A}, V_{\text{CE}} = 2\text{V}$	75	-	-	-
		$I_C = 50\text{A}, V_{\text{CE}} = 5\text{V}$	100	-	-	-
Diode Forward Voltage	$V_{\text{FM}}$	$I_{\text{FM}} = 50\text{A}$	-	-	1.75	Volts
Collector-Emitter Saturation Voltage	$V_{\text{CE(sat)}}$	$I_C = 50\text{A}, I_B = 0.65\text{A}$	-	-	2.0	Volts
Base-Emitter Saturation Voltage	$V_{\text{BE(sat)}}$	$I_C = 50\text{A}, I_B = 0.65\text{A}$	-	-	2.5	Volts
Resistive Load	$t_{\text{on}}$	$V_{\text{CC}} = 300\text{V}$	-	-	1.5	$\mu\text{s}$
		$I_C = 50\text{A}$	-	-	12	$\mu\text{s}$
Switch Times	$t_f$	$I_{\text{B1}} = I_{\text{B2}} = -1\text{A}$	-	-	3.0	$\mu\text{s}$



Powerex, Inc., 200 Hillis Street, Youngwood, Pennsylvania 15697-1800 (412) 925-7272

**KS524505**  
**Single Darlington Transistor Module**  
**50 Amperes/600 Volts**

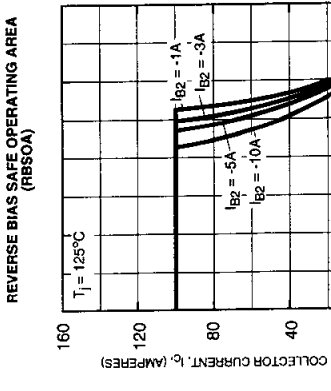
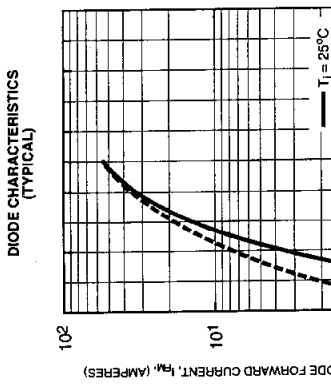
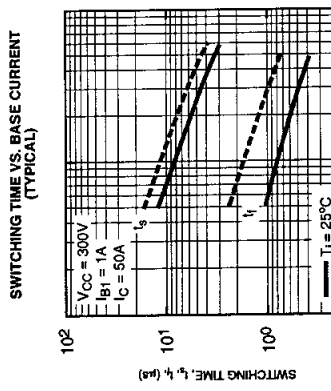
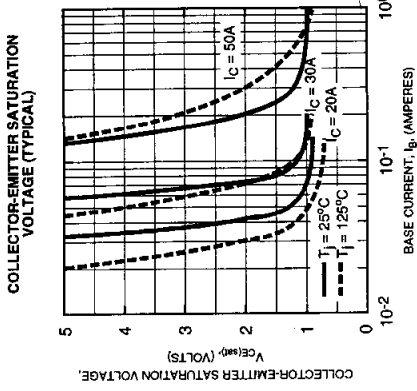
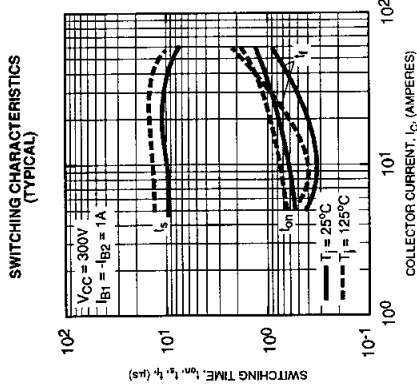
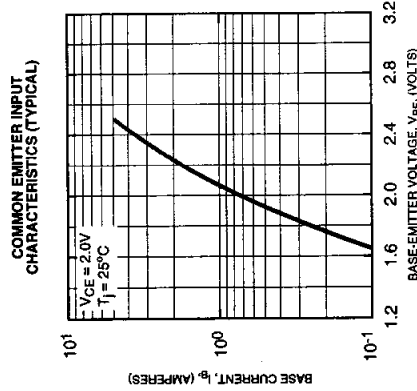
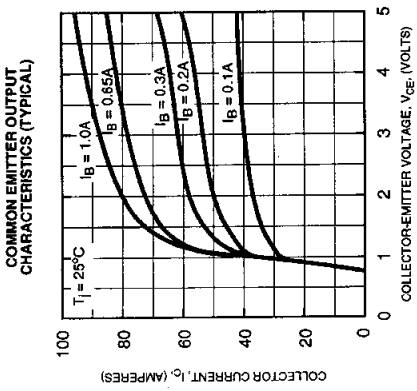
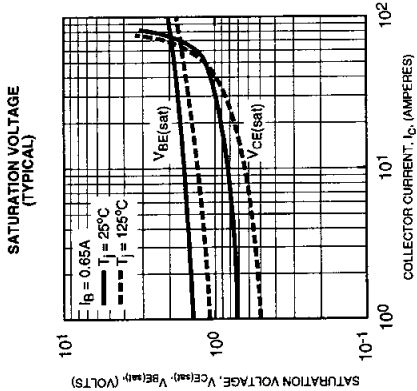
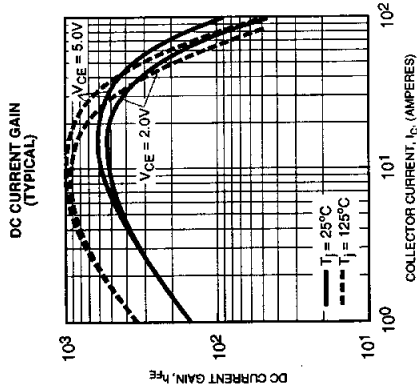



Powerex, Inc., 200 Hillis Street, Youngwood, Pennsylvania 15697-1800 (412) 925-7272

**KS524505**  
**Single Darlington Transistor Module**  
 50 Amperes/600 Volts

