

FAIRCHILD
SEMICONDUCTOR®

KSC5502D/KSC5502DT

High Voltage Power Switch Switching Application

- Wide Safe Operating Area
- Built-in Free-Wheeling Diode
- Suitable for Electronic Ballast Application
- Small Variance in Storage Time
- Two Package Choices : D-PAK or TO-220

Equivalent Circuit

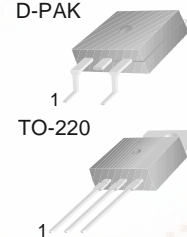
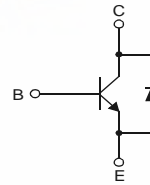

1.Base 2.Collector 3.Emitter

NPN Triple Diffused Planar Silicon Transistor

Absolute Maximum Ratings $T_C=25^\circ\text{C}$ unless otherwise noted

Symbol	Parameter	Value	Units
V_{CB0}	Collector-Base Voltage	1200	V
V_{CEO}	Collector-Emitter Voltage	600	V
V_{EBO}	Emitter-Base Voltage	12	V
I_C	Collector Current (DC)	2	A
I_{CP}	*Collector Current (Pulse)	4	A
I_B	Base Current (DC)	1	A
I_{BP}	*Base Current (Pulse)	2	A
P_C	Collector Dissipation ($T_C=25^\circ\text{C}$)	50	W
T_J	Junction Temperature	150	$^\circ\text{C}$
T_{STG}	Storage Temperature	- 65 ~ 150	$^\circ\text{C}$
EAS	Avalanche Energy($T_J=25^\circ\text{C}$)	2.5	mJ

* Pulse Test : Pulse Width = 5ms, Duty Cycle \leq 10%

Thermal Characteristics $T_C=25^\circ\text{C}$ unless otherwise noted

Symbol	Characteristics		Rating	Unit
$R_{\theta jc}$	Thermal Resistance	Junction to Case	2.5	$^\circ\text{C}/\text{W}$
$R_{\theta ja}$		Junction to Ambient	62.5	
T_L	Maximun Lead Temperature for Soldering Purpose : 1/8" from Case for 5 seconds		270	$^\circ\text{C}$

KSC5502D/KSC5502DT

Electrical Characteristics $T_C=25^\circ\text{C}$ unless otherwise noted

Symbol	Parameter	Test Condition	Min.	Typ.	Max.	Units	
BV_{CBO}	Collector-Base Breakdown Voltage	$I_C=1\text{mA}, I_E=0$	1200	1350		V	
BV_{CEO}	Collector-Emitter Breakdown Voltage	$I_C=5\text{mA}, I_B=0$	600	750		V	
BV_{EBO}	Emitter-Base Breakdown Voltage	$I_E=500\mu\text{A}, I_C=0$	12	13.7		V	
I_{CES}	Collector Cut-off Current	$V_{CES}=1200\text{V}, V_{BE}=0$	$T_C=25^\circ\text{C}$			100	μA
			$T_C=125^\circ\text{C}$			500	
I_{CEO}	Collector Cut-off Current	$V_{CE}=600\text{V}, I_B=0$	$T_C=25^\circ\text{C}$			100	μA
			$T_C=125^\circ\text{C}$			500	
I_{EBO}	Emitter Cut-off Current	$V_{EB}=12\text{V}, I_C=0$			10	μA	
h_{FE}	DC Current Gain	$V_{CE}=1\text{V}, I_C=0.2\text{A}$	$T_C=25^\circ\text{C}$	15	28	40	
			$T_C=125^\circ\text{C}$	8	18		
		$V_{CE}=1\text{V}, I_C=1\text{A}$	$T_C=25^\circ\text{C}$	4	6.4		
			$T_C=125^\circ\text{C}$	3	4.7		
		$V_{CE}=2.5\text{V}, I_C=0.5\text{A}$	$T_C=25^\circ\text{C}$	12	20	30	
			$T_C=125^\circ\text{C}$	6	12		
$V_{CE}(\text{sat})$	Collector-Emitter Saturation Voltage	$I_C=0.2\text{A}, I_B=0.02\text{A}$	$T_C=25^\circ\text{C}$		0.31	0.8	V
			$T_C=125^\circ\text{C}$		0.54	1.1	V
		$I_C=0.4\text{A}, I_B=0.08\text{A}$	$T_C=25^\circ\text{C}$		0.15	0.6	V
			$T_C=125^\circ\text{C}$		0.23	1.0	V
		$I_C=1\text{A}, I_B=0.2\text{A}$	$T_C=25^\circ\text{C}$		0.40	1.5	V
			$T_C=125^\circ\text{C}$		1.3	3.0	V
$V_{BE}(\text{sat})$	Base-Emitter Saturation Voltage	$I_C=0.4\text{A}, I_B=0.08\text{A}$	$T_C=25^\circ\text{C}$		0.77	1.0	V
			$T_C=125^\circ\text{C}$		0.60	0.9	V
		$I_C=1\text{A}, I_B=0.2\text{A}$	$T_C=25^\circ\text{C}$		0.83	1.2	V
			$T_C=125^\circ\text{C}$		0.70	1.0	V
C_{ib}	Input Capacitance	$V_{EB}=8\text{V}, I_C=0, f=1\text{MHz}$		385	500	pF	
C_{ob}	Output Capacitance	$V_{CB}=10\text{V}, I_E=0, f=1\text{MHz}$		60	100	pF	
f_T	Current Gain Bandwidth Product	$I_C=0.5\text{A}, V_{CE}=10\text{V}$		11		MHz	
V_F	Diode Forward Voltage	$I_F=0.2\text{A}$	$T_C=25^\circ\text{C}$		0.75	1.2	V
			$T_C=125^\circ\text{C}$		0.59		V
		$I_F=0.4\text{A}$	$T_C=25^\circ\text{C}$		0.80	1.3	V
			$T_C=125^\circ\text{C}$		0.64		V
		$I_F=1\text{A}$	$T_C=25^\circ\text{C}$		0.9	1.5	V
			$T_C=125^\circ\text{C}$				

Electrical Characteristics $T_C=25^\circ\text{C}$ unless otherwise noted

Symbol	Parameter	Test Condition	Min	Typ.	Max.	Units
t_{fr}	Diode Forward Recovery Time ($di/dt=10\text{A}/\mu\text{s}$)	$I_F=0.2\text{A}$		650		ns
		$I_F=0.4\text{A}$		740		ns
		$I_F=1\text{A}$		785		ns
$V_{CE(DSAT)}$	Dynamic Saturation Voltage	$I_C=0.4\text{A}, I_{B1}=80\text{mA}$ $V_{CC}=300\text{V}$	@ $1\mu\text{s}$	7.2		V
			@ $3\mu\text{s}$	1.8		V
		$I_C=1\text{A}, I_{B1}=200\text{mA}$ $V_{CC}=300\text{V}$	@ $1\mu\text{s}$	18		V
			@ $3\mu\text{s}$	6		V
RESISTIVE LOAD SWITCHING (D.C. $\leq 10\%$, Pulse Width=20s)						
t_{ON}	Turn On Time	$I_C=0.4\text{A},$ $I_{B1}=80\text{mA}$	$T_C=25^\circ\text{C}$	175	350	ns
			$T_C=125^\circ\text{C}$	185		ns
t_{OFF}	Turn Off Time	$I_{B2}=0.2\text{A},$ $V_{CC}=300\text{V}$ $R_L = 750\Omega$	$T_C=25^\circ\text{C}$	2.1	3.0	μs
			$T_C=125^\circ\text{C}$	2.6		μs
t_{ON}	Turn On Time	$I_C=1\text{A},$ $I_{B1}=160\text{mA}$	$T_C=25^\circ\text{C}$	240	450	ns
			$T_C=125^\circ\text{C}$	310		ns
t_{OFF}	Turn Off Time	$I_{B2}=160\text{mA},$ $V_{CC}=300\text{V}$ $R_L = 300\Omega$	$T_C=25^\circ\text{C}$	3.7	5.0	μs
			$T_C=125^\circ\text{C}$	4.5		μs
INDUCTIVE LOAD SWITCHING ($V_{CC}=15\text{V}$)						
t_{STG}	Storage Time	$I_C=0.4\text{A},$ $I_{B1}=80\text{mA}$	$T_C=25^\circ\text{C}$	1.2	2.0	μs
			$T_C=125^\circ\text{C}$	1.5		μs
t_F	Fall Time	$I_{B2}=0.2\text{A},$ $V_Z=300\text{V}$ $L_C=200\text{H}$	$T_C=25^\circ\text{C}$	90	200	ns
			$T_C=125^\circ\text{C}$	65		ns
t_C	Cross-over Time		$T_C=25^\circ\text{C}$	185	350	ns
			$T_C=125^\circ\text{C}$	145		ns
t_{STG}	Storage Time	$I_C=0.8\text{A},$ $I_{B1}=160\text{mA}$	$T_C=25^\circ\text{C}$	3.3	4.5	μs
			$T_C=125^\circ\text{C}$	3.75		μs
t_F	Fall Time	$I_{B2}=160\text{mA},$ $V_{CC}=300\text{V}$ $L_C=200\text{H}$	$T_C=25^\circ\text{C}$	90	250	ns
			$T_C=125^\circ\text{C}$	160		ns
t_C	Cross-over Time		$T_C=25^\circ\text{C}$	300	600	ns
			$T_C=125^\circ\text{C}$	570		ns

Typical Characteristics

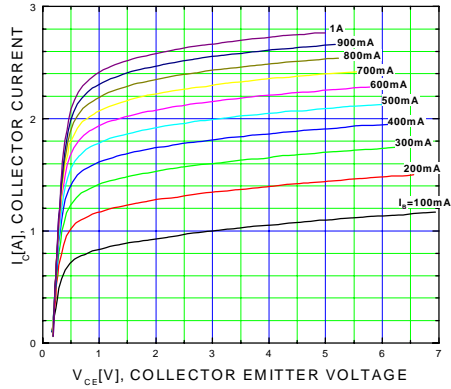

Figure 1. Static Characteristic

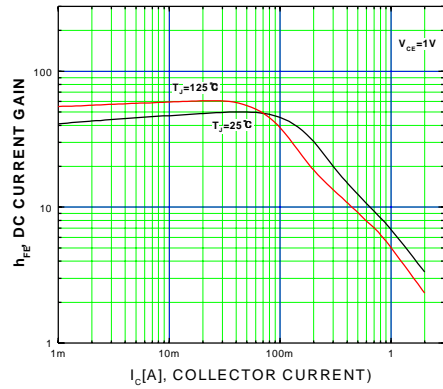

Figure 2. DC current Gain

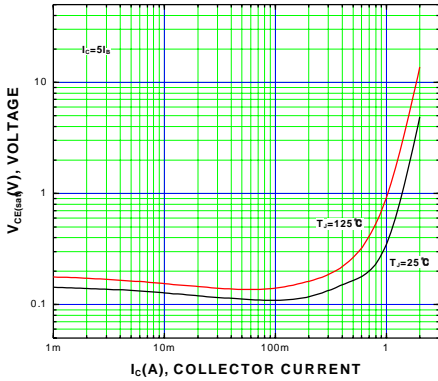

Figure 3. Collector-Emitter Saturation Voltage

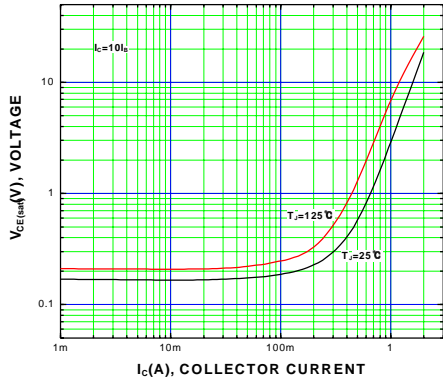

Figure 4. Collector-Emitter Saturation Voltage

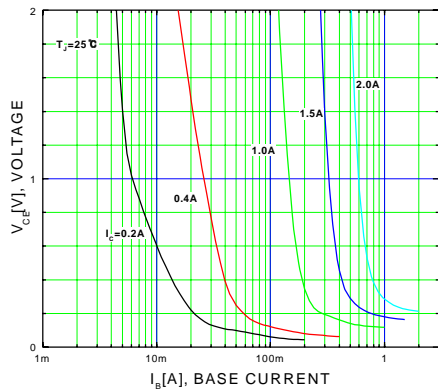

Figure 5. Typical Collector Saturation Voltage

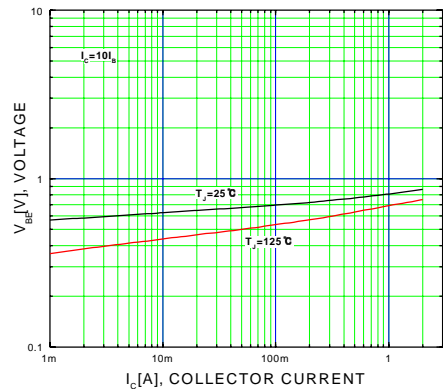

Figure 6. Base-Emitter Saturation Voltage

Typical Characteristics (Continued)

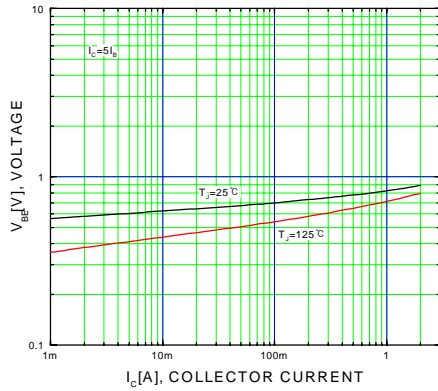

Figure 7. Base-Emitter Saturation Voltage

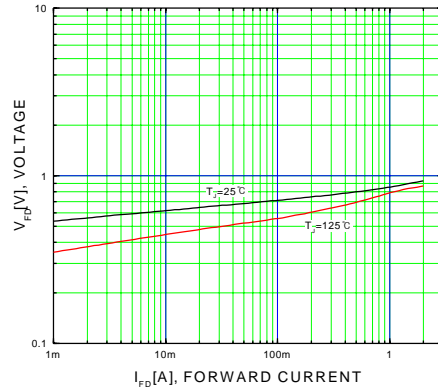

Figure 8. Diode Forward Voltage

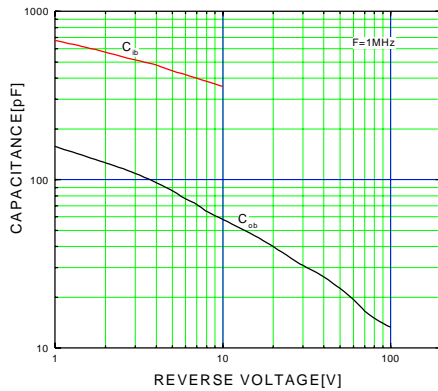

Figure 9. Collector Output Capacitance

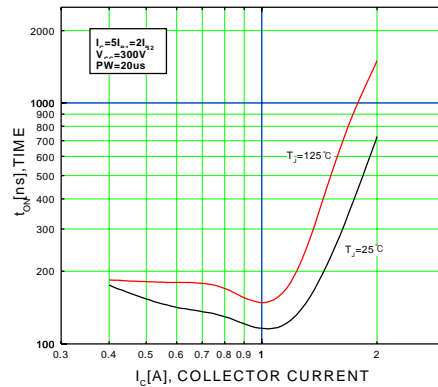

Figure 10. Resistive Switching Time, t_{on}

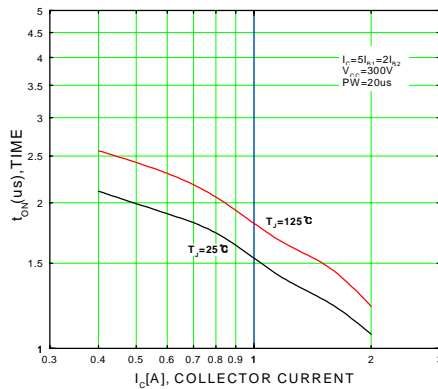

Figure 11. Resistive Switching Time, t_{off}

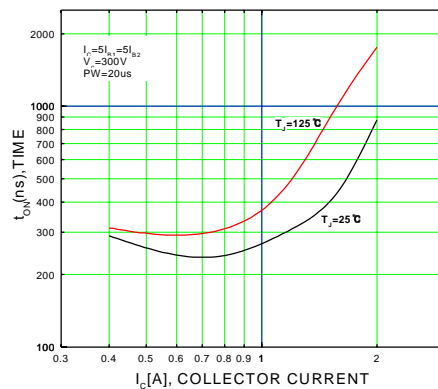

Figure 12. Resistive Switching Time, t_{on}

Typical Characteristics (Continued)

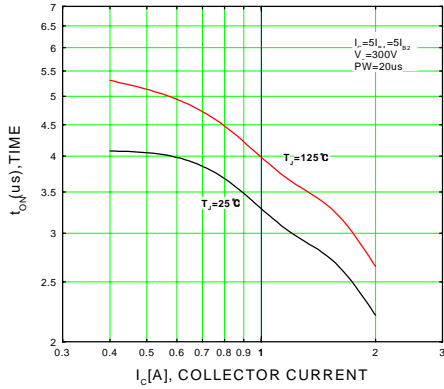

Figure 13. Resistive Switching Time, t_{on}

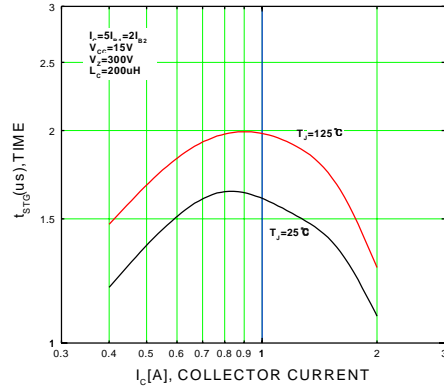

Figure 14. Inductive Switching Time, t_{STG}

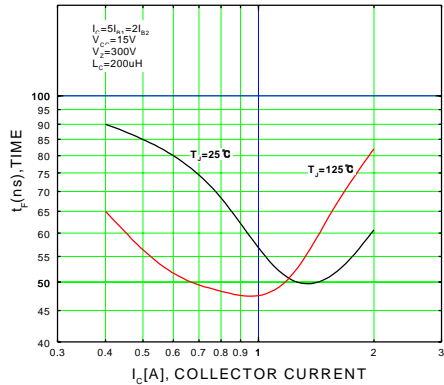

Figure 15. Inductive Switching Time, t_f

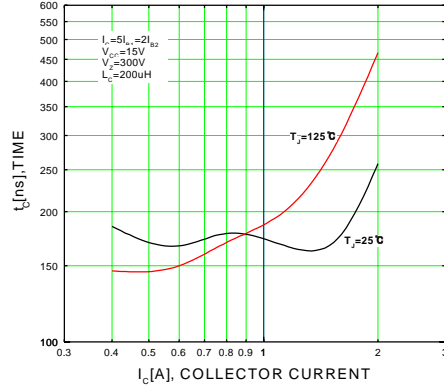

Figure 16. Inductive Switching Time, t_c

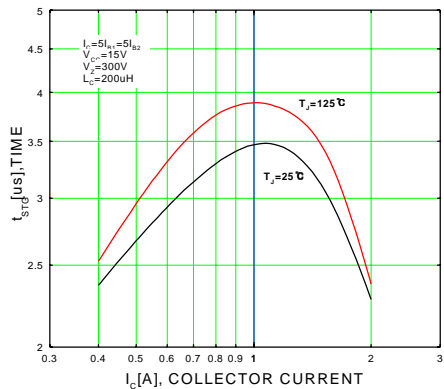

Figure 17. Inductive Switching Time, t_{STG}

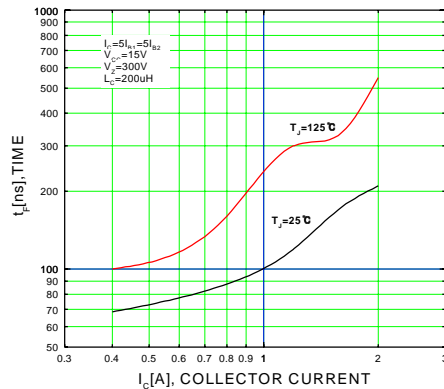

Figure 18. Inductive Switching Time, t_f

Typical Characteristics (Continued)

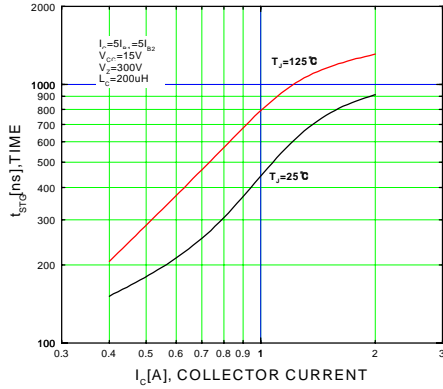

Figure 19. Inductive Switching Time, t_{STG}

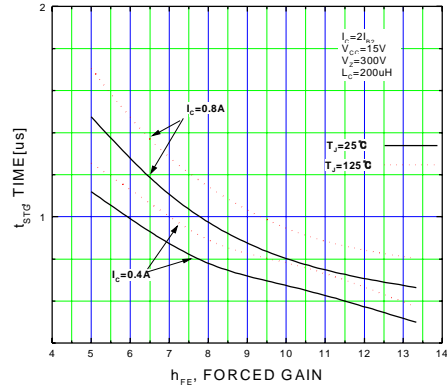

Figure 20. Inductive Switching Time, t_{STG}

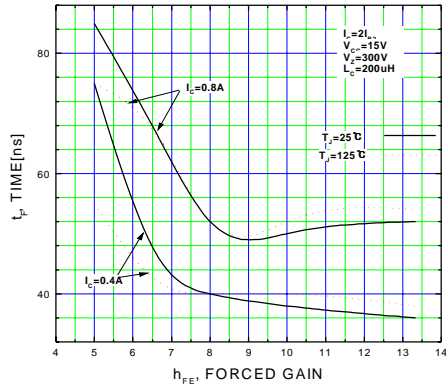

Figure 21. Inductive Switching Time, t_F

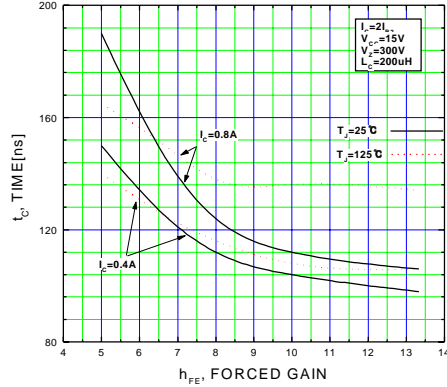

Figure 22. Inductive Switching Time, t_C

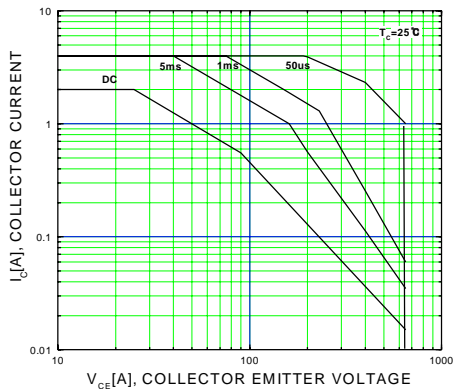

Figure 23. Forward Bias Safe Operating Area

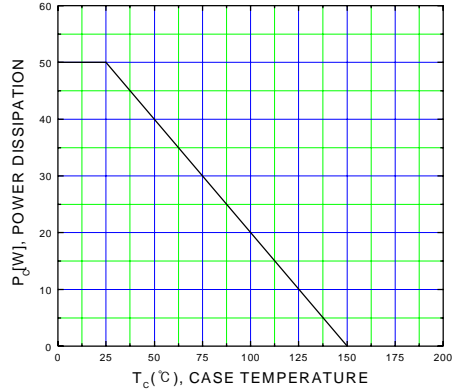

Figure 24. Power Derating

Typical Characteristics (Continued)

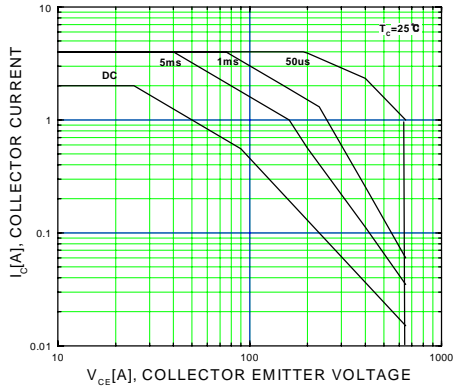

Figure 25. Forward Bias Safe Operating Area

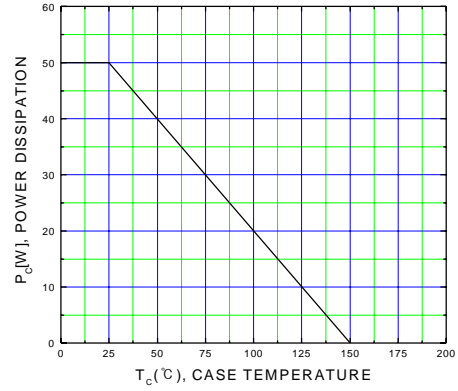
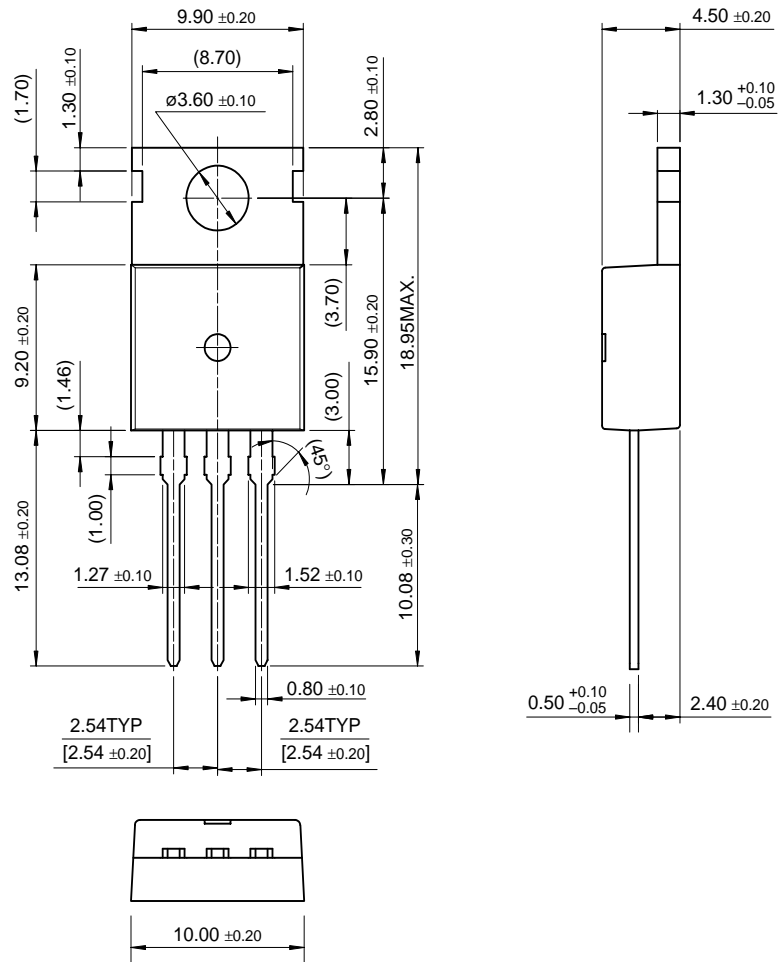

Figure 26. Power Derating

Package Dimensions

TO-220



KSC5502D/KSC5502DT

Dimensions in Millimeters

Package Dimensions (Continued)

D-PAK

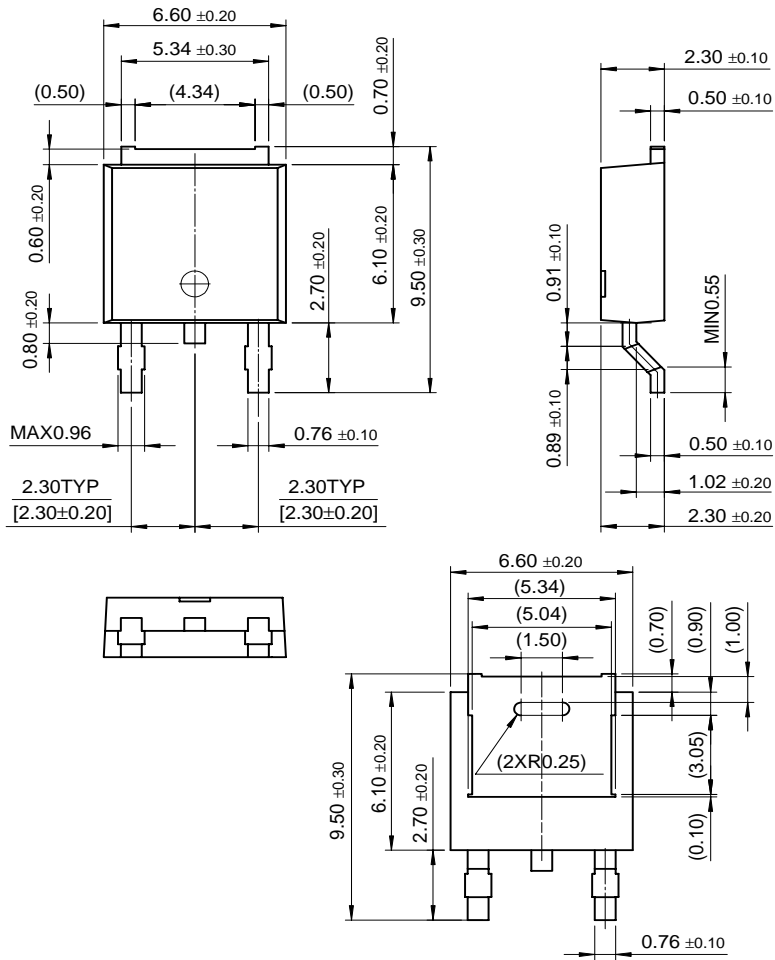

Dimensions in Millimeters

KSC5502D/KSC5502DT

TRADEMARKS

The following are registered and unregistered trademarks Fairchild Semiconductor owns or is authorized to use and is not intended to be an exhaustive list of all such trademarks.

ACE ^x TM	FAST [®]	OPTOPLANAR TM	STAR*POWER TM
Bottomless TM	FAST ^r TM	PACMAN TM	Stealth TM
CoolFET TM	FRFET TM	POP TM	SuperSOT TM -3
CROSSVOLT TM	GlobalOptoisolator TM	Power247 TM	SuperSOT TM -6
DenseTrench TM	GTO TM	PowerTrench [®]	SuperSOT TM -8
DO ^{ME} TM	HiSeC TM	QFET TM	SyncFET TM
EcoSPARK TM	ISOPLANAR TM	QS TM	TruTranslation TM
E ² CMOS TM	LittleFET TM	QT Optoelectronics TM	TinyLogic TM
EnSigna TM	MicroFET TM	Quiet Series TM	UHC TM
FACT TM	MICROWIRE TM	SLIENT SWITCHER [®]	UltraFET [®]
FACT Quiet Series TM	OPTOLOGIC TM	SMART START TM	VCX TM

STAR*POWER is used under license

DISCLAIMER

FAIRCHILD SEMICONDUCTOR RESERVES THE RIGHT TO MAKE CHANGES WITHOUT FURTHER NOTICE TO ANY PRODUCTS HEREIN TO IMPROVE RELIABILITY, FUNCTION OR DESIGN. FAIRCHILD DOES NOT ASSUME ANY LIABILITY ARISING OUT OF THE APPLICATION OR USE OF ANY PRODUCT OR CIRCUIT DESCRIBED HEREIN; NEITHER DOES IT CONVEY ANY LICENSE UNDER ITS PATENT RIGHTS, NOR THE RIGHTS OF OTHERS.

LIFE SUPPORT POLICY

FAIRCHILD'S PRODUCTS ARE NOT AUTHORIZED FOR USE AS CRITICAL COMPONENTS IN LIFE SUPPORT DEVICES OR SYSTEMS WITHOUT THE EXPRESS WRITTEN APPROVAL OF FAIRCHILD SEMICONDUCTOR CORPORATION.

As used herein:

1. Life support devices or systems are devices or systems which, (a) are intended for surgical implant into the body, or (b) support or sustain life, or (c) whose failure to perform when properly used in accordance with instructions for use provided in the labeling, can be reasonably expected to result in significant injury to the user.
2. A critical component is any component of a life support device or system whose failure to perform can be reasonably expected to cause the failure of the life support device or system, or to affect its safety or effectiveness.

PRODUCT STATUS DEFINITIONS

Definition of Terms

Datasheet Identification	Product Status	Definition
Advance Information	Formative or In Design	This datasheet contains the design specifications for product development. Specifications may change in any manner without notice.
Preliminary	First Production	This datasheet contains preliminary data, and supplementary data will be published at a later date. Fairchild Semiconductor reserves the right to make changes at any time without notice in order to improve design.
No Identification Needed	Full Production	This datasheet contains final specifications. Fairchild Semiconductor reserves the right to make changes at any time without notice in order to improve design.
Obsolete	Not In Production	This datasheet contains specifications on a product that has been discontinued by Fairchild semiconductor. The datasheet is printed for reference information only.