

cosmo

Solid State Relay

KSD205AC3

Features

1. Molded epoxy body.
2. Zero crossing circuit.
3. High input/output insulation.
4. Small size and light weight.
5. Can be installed directly on the PC board.
6. Fast reactive speed.
7. Normally open.

Applications

1. Household Appliances.
2. Temperature Control System.
3. Industrial Automatic Control.
4. Lighting System.
5. Office Appliances.
6. Factory Appliances.

Outside Dimension : Unit (mm)

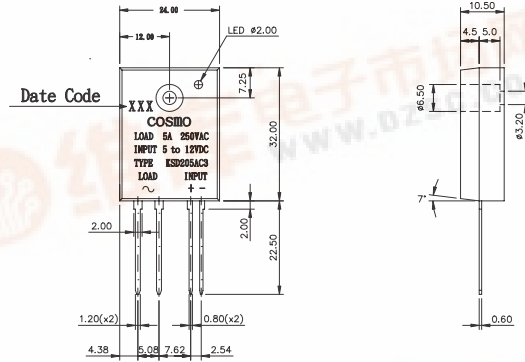

Schematic : Top View

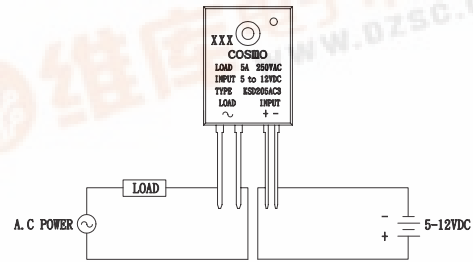

Absolute Maximum Ratings

(Ta=25°C)

Parameter	Symbol	Rating	Unit
Input	Input Signal Voltage	V _{IN}	5~12
	Drop-out Voltage	V _{do}	1
Output	RMS on-state current	I _T	5 Arms
	Peak one cycle surge current (8.3 ms)	I _{surge}	50 A
	Repetitive peak-off state Voltage	V _{DRM}	600 V
	Operating frequency	f	47~70 Hz
	Critical rate of rise of on-state current	di/dt	50 A/μS
	Load supply voltage	V _{out}	250 Vrms AC
Isolation Voltage input to output	V _{iso}	4000 Vrms	
Operating Temperature	T _{opr}	-30~100 °C	
Storage Temperature	T _{stg}	-30~125 °C	
Soldering Temperature 10 Sec	T _{sol}	260 °C	

Electrical Characteristics

(Ta=25°C)

Parameter	Symbol	Conditions	MIN	TYP	MAX	Unit
Input	Pick-up Voltage	V _{pu}			4	VDC
	Input current	I _{in}	V _{in} =5-12V	5	25	mA
Output	On-state Voltage	V _T	I _T =1Arms		1.5	Vrms
	Operating Current	I _{op}	V _{out} =240Vrms	50		mArms
	Leakage Current	I _{leak}	V _{out} =240Vrms		7	mArms
	Critical rate of rise of off-state Voltage	dv/dt	See Note 1	50	200	V/μS
	Zero-cross Voltage				Yes	
	Load Voltage Rating	V _{out}	I _T =50mArms MIN	50		280 VAC
Minimum trigger current	I _{FT}	V _{DRM} =600V			10	mA
Isolation resistance input to output	R _{iso}	DC500V	10 ¹⁰			Ω
Turn-on time	T _{on}	60Hz AC			8.3	mS
Turn-off time	T _{off}	60Hz AC			8.3	mS
Thermal resistance (between junction and case)	R _{th (j-c)}	I		1.3		°C/W

Note 1 : Output (dv/dt) protection is provided in all models, and they are designed to switch resistive or inductive loads to 0.2 power factor. The dv/dt rating is based on source impedance of 50 ohms.



Data Curve

Fig.1 RMS On-state Current vs. Ambient Temperature

- (1) With infinite heat sink
- (2) With heat sink (70x70x2mm Al plate)
- (3) With heat sink (50x50x2mm Al plate)
- (4) Without heat sink

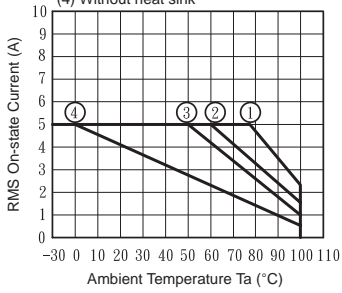

Fig.2 Surge Current vs. Time

f=60Hz
Tj=25°C

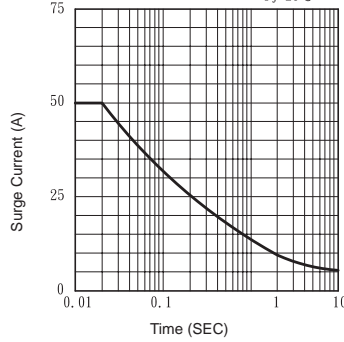

Fig.3 Open Circuit Leak Current vs. Supply Voltage

Ta=25°C

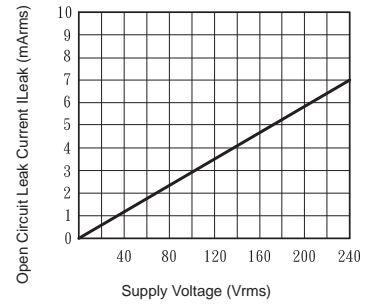

Fig.4 RMS On-state Current vs. Case Temperature

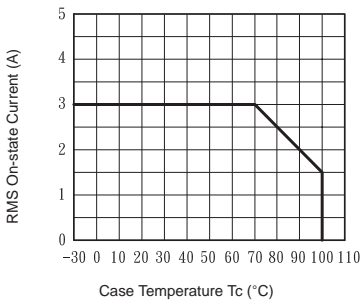

Fig.5 Input Voltage vs. Ambient Temperature

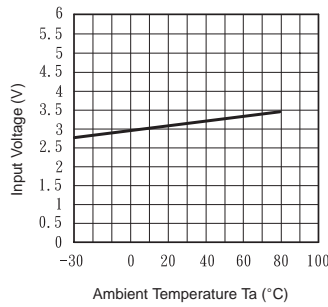

Fig.6 Input Current vs. Input voltage

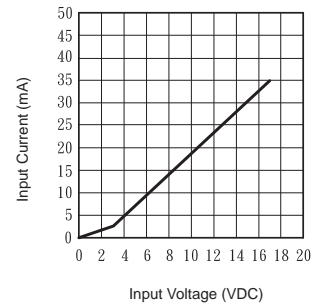

Fig.7 Action waveform

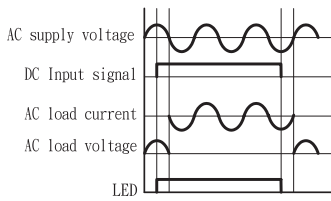

Fig.8 WIRING DIAGRAM

