

PRODUCT SPECIFICATION

COSMO ELECTRONICS CORPORATION	SOLID STATE RELAY: KSD225AC3	SHEET 1 OF 2
---	---	---------------------

1. OUTSIDE DIMENSION : UNIT (mm)

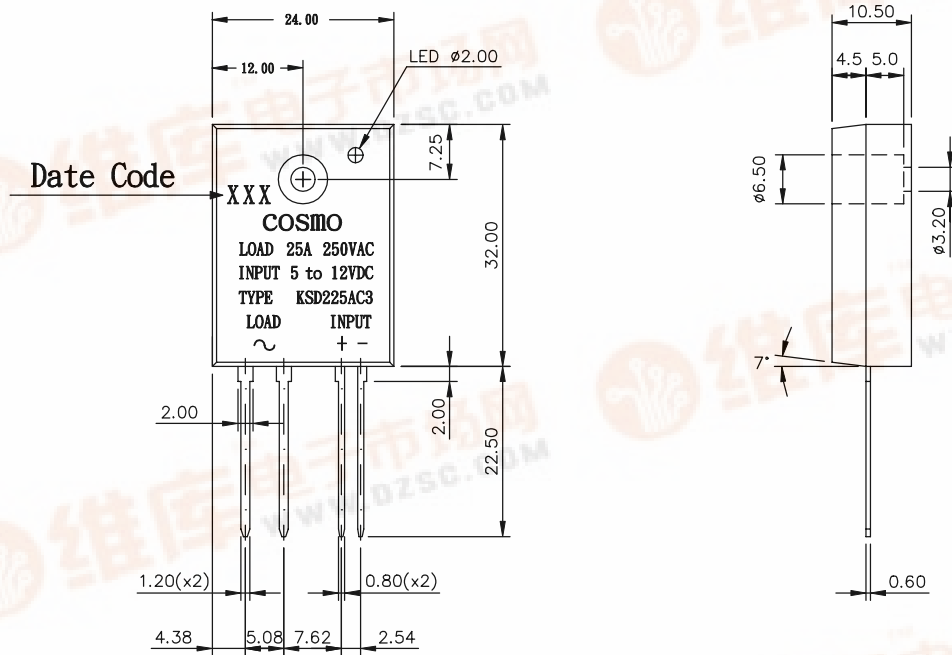

2. SCHEMATIC : TOP VIEW

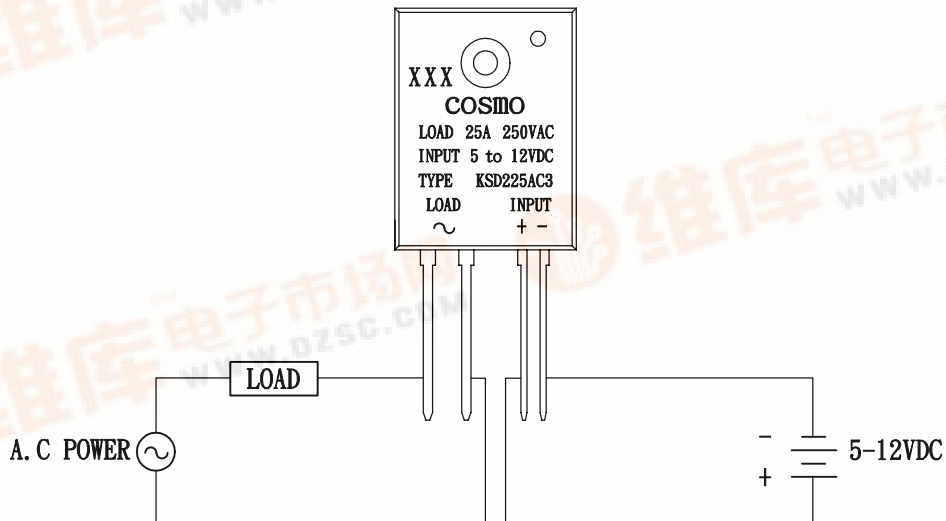

PRODUCT SPECIFICATION

COSMO ELECTRONICS CORPORATION	SOLID STATE RELAY: KSD225AC3	SHEET 2 OF 2
---	--	--------------

3. Absolute Maximum Ratings

(Ta=25°C)

Parameter		Symbol	Rating	Unit
Input	Input signal voltage	V _{IN}	5~12	VDC
	Drop-out voltage	V _{do}	1	VDC
Output	RMS on-state current	I _T	25	Arms
	Peak one cycle surge current	I _{surge}	250	A
	Repetitive peak-off state voltage	V _{DRM}	600	V
	Operating frequency	f	47~70	Hz
	Critical rate of rise of on-state current	di/dt	50	A/us
	Load supply voltage	V _{out}	250	V _{rms} AC
Isolation voltage input to output		V _{iso}	4000	V _{rms}
Operating temperature		T _{opr}	-30~100	°C
Storage temperature		T _{stg}	-30~125	°C
Soldering temperature 10sec		T _{sol}	260	°C

4. Electrical Characteristics

(Ta=25°C)

Parameter		Symbol	Conditions	MIN	TYP	MAX	Unit
Input	Pick-up voltage	V _{pu}	I _t =1Arms			4	VDC
	Input current	I _{in}	V _{in} =5~12V	5		25	mA
Output	On-state voltage	V _T	I _T =1Arms			1.5	V _{rms}
	Operating current	I _{op}	V _{out} =240vrms	50			mArms
	Leakage current	I _{leak}	V _{out} =240vrms			7	mArms
	Critical rate of rise of off-state voltage	dv/dt	See Note 1	50	200		V/us
	Zero-cross voltage	V _{ox}	I _{in} =7mA	50		35	VAC
	Load Voltage Rating	V _{out}	I _T =50mArms MIN			280	VAC
Minimum trigger current		I _{FT}	V _{DRM} =600V			25	mA
Isolation resistance input to output		R _{iso}	DC500V	10 ¹⁰			Ω
Turn-on time		T _{on}	60Hz AC			8.3	ms
Turn-off time		T _{off}	60Hz AC			8.3	ms
Thermal resistance (between junction and case)		R _{th} (j-c)l			1.2		°C/W