



FRD Type : KSF30A40B

OUTLINE DRAWING

FEATURES

- * Similar to TO-247AC(TO-3P)Case
- * Ultra-Fast Recovery
- * Low Forward Voltage Drop
- * Low Power Loss,High Efficiency
- * High Surge Current Capability
- * 200Volts thru 600Volts Type Available

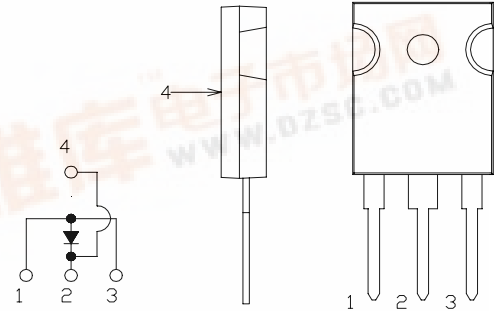

Maximum Ratings

Approx Net Weight: 5.55g

Rating	Symbol	KSF30A40B		Unit
Repetitive Peak Reverse Voltage	V_{RRM}	400		V
Average Rectified Output Current *1	I_O	30	$T_c=90^{\circ}C$ 50 Hz half Sine Wave Resistive Load	A
RMS Forward Current	$I_{F(RMS)}$	47		A
Surge Forward Current	I_{FSM}	400	50Hz Half Sine Wave ,1cycle Non-repetitive	A
Operating JunctionTemperature Range	T_{jw}	-40 to +150		$^{\circ}C$
Storage Temperature Range	T_{stg}	-40 to +150		$^{\circ}C$
Mounting torque	F_{tor}	recommended torque = 0.5		N•m

*1:Anode Terminals 1 and 3 Connected

Electrical • Thermal Characteristics

Characteristics	Symbol	Conditions	Min.	Typ.	Max.	Unit
Peak Reverse Current	I_{RM}	$T_j= 25^{\circ}C, V_{RM}= V_{RRM}$	-	-	50	μA
Peak Forward Voltage *1	V_{FM}	$T_j= 25^{\circ}C, I_{FM}= 30 A$	-	-	1.25	V
Reverse Recovery Time	t_{rr}	$I_{FM}= 10A, -di/dt=50A/\mu s, T_a=25^{\circ}C$			60	ns
Thermal Resistance	$R_{th(j-c)}$	Junction to Case	-	-	1.4	$^{\circ}C/W$

*1:Anode Terminals 1 and 3 Connected



KSF30A40B OUTLINE DRAWING (Dimensions in mm)

