

### VARIABLE CAPACITANCE DIODE

#### FEATURES

- Excellent Linearity (CV Curve)
- Large Capacitance Ratio ( $A = 3.70$  minimum) with Low Series Resistance
- Two Diodes in a 3 Lead Through-Hole Discrete Package (TO92-3)
- Very Small Capacitance Deviation at Tape/Reel

#### APPLICATIONS

- FM Radio
- Voltage Controlled Oscillator

#### DESCRIPTION

The KV1330NT variable capacitance diode was specially made to be used as tuning elements in car radios, radio cassettes, stereos, and other consumer radios. The KV1330NT is suitable for wide band tuning from 76 to 108 MHz.

If the KV1330NT is used only for FM reception, it is possible to operate it at 4.5 V so it is very useful in lowering the power demands of the set.

#### CLASSIFICATION

(Unit: pF)

C	RANK	1	2	3	4
	C <sub>2</sub>	MIN	69.14	71.09	73.09
MAX		71.23	73.24	75.31	77.43

#### ORDERING INFORMATION

KV1330NT

Note: The KV1330NT is supplied on folded paper tape (25 pieces per fold) 1500 pcs per box.

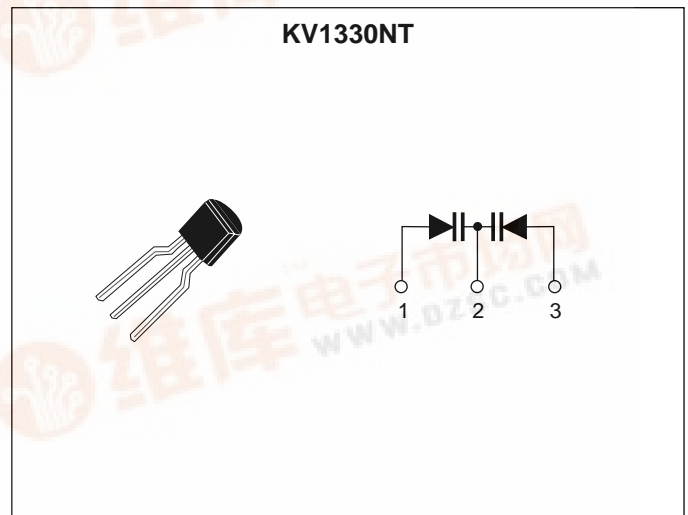

# KV1330NT

## ABSOLUTE MAXIMUM RATINGS

Reverse Voltage ..... 18V      Storage Temperature Range ..... -55 to +150 °C  
Forward Current ..... 50 mA      Operating Temperature Range ..... -55 to +85 °C  
Power Dissipation ..... 100 mW

## ELECTRICAL CHARACTERISTICS

Test conditions:  $T_A = 25\text{ °C}$

SYMBOL	PARAMETER	TEST CONDITIONS	MIN	TYP	MAX	UNITS
$V_{REV}$	Reverse Voltage	$I_{REV} = 10\ \mu\text{A}$	16			V
$I_{REV}$	Reverse Current	$V_{REV} = 10.0\ \text{V}$			100	nA
$C_2$	Diode Capacitance 2	$V_{REV} = 2.0\ \text{V}, f = 1\ \text{MHz}$	69.14		77.43	pF
$C_4$	Diode Capacitance 4	$V_{REV} = 4.0\ \text{V}, f = 1\ \text{MHz}$	43.09		56.24	pF
$C_6$	Diode Capacitance 6	$V_{REV} = 6.0\ \text{V}, f = 1\ \text{MHz}$	25.05		34.57	pF
$C_9$	Diode Capacitance 9	$V_{REV} = 9.0\ \text{V}, f = 1\ \text{MHz}$	15.44		20.10	pF
$R_s$	Series Resistance	$V_{REV} = 2.0\ \text{V}, f = 70\ \text{MHz}$			0.5	$\Omega$
A	Capacitance Ratio	$C_2 / C_9$	3.70		5.00	

Note 1: Diode Capacitance measured with HP 4279A or equivalent instruments (at OSC level 20 mVrms,  $\pm 5\ \text{mVrms}$ ).

Note 2: Series Resistance measured with HP 4191A or equivalent instruments.

Note 3: The tolerance of two adjacent parts on a reel is within 3% at C2, C3, C6, and C9.

TYPICAL PERFORMANCE CHARACTERISTICS

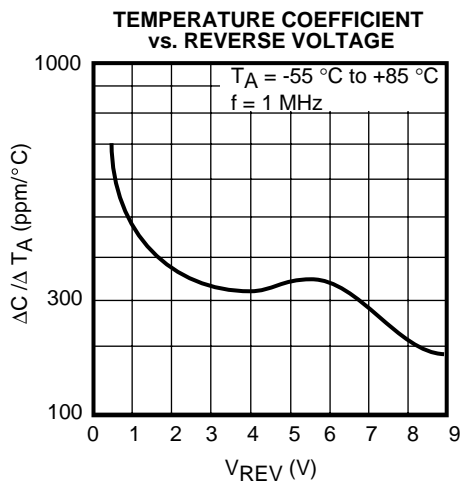
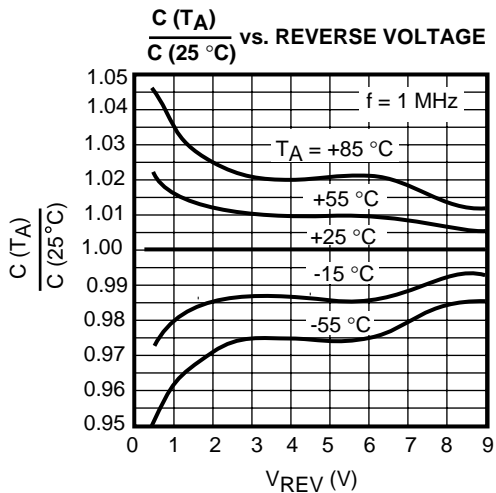
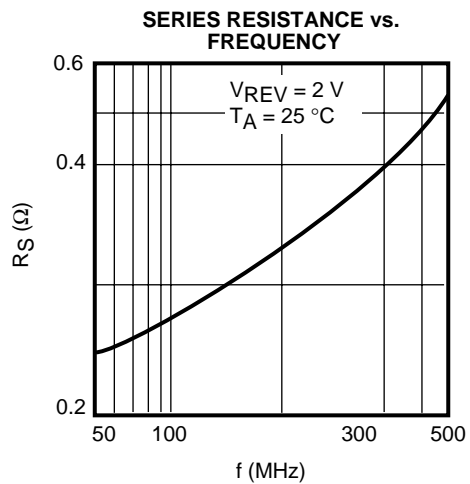
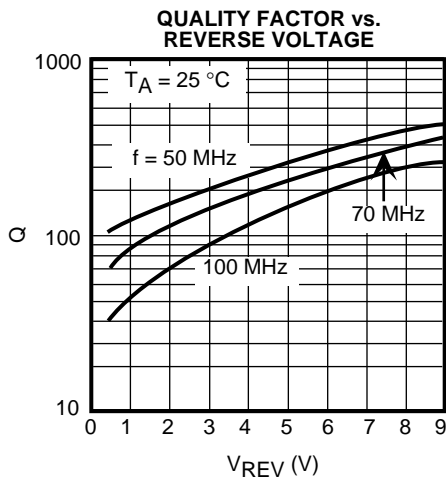
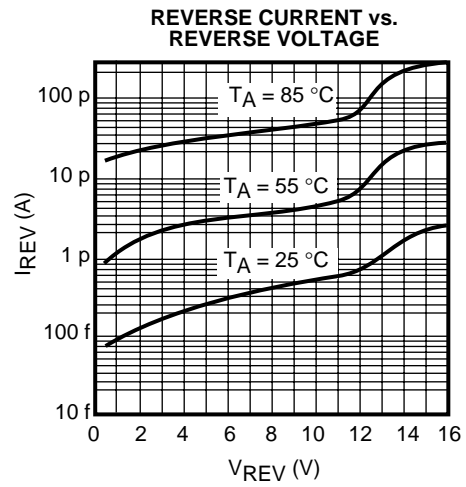
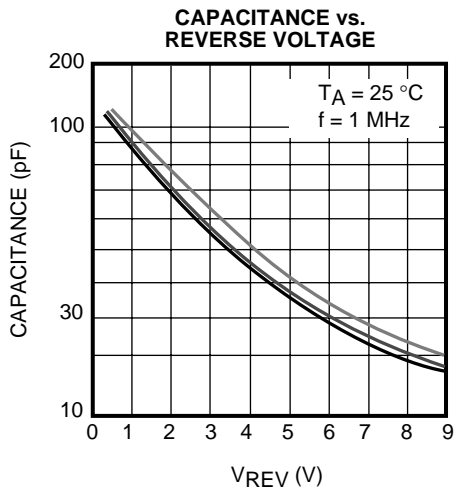

# KV1330NT

## PACKAGE OUTLINE

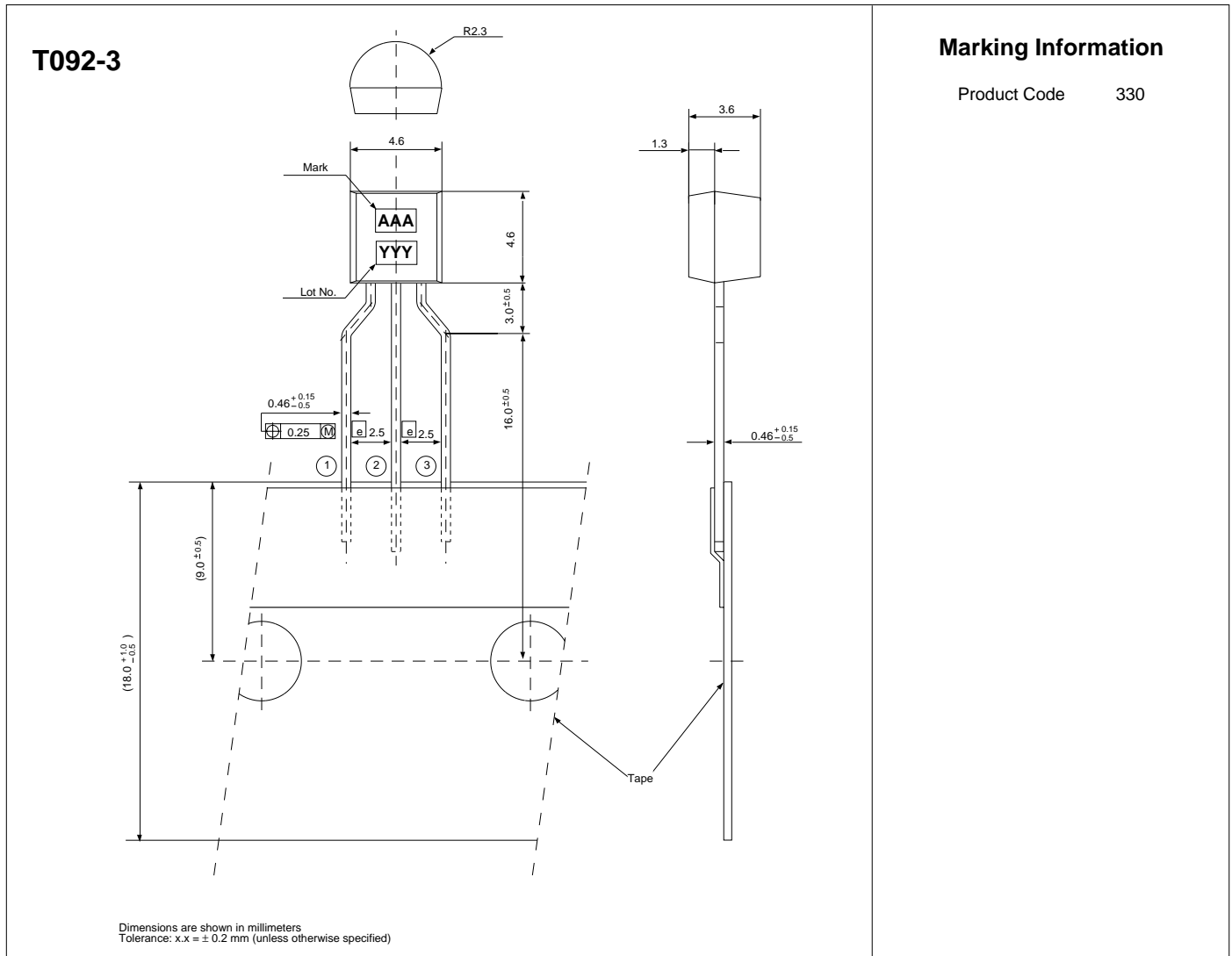

Toko America, Inc. Headquarters  
1250 Feehanville Drive, Mount Prospect, Illinois 60056  
Tel: (847) 297-0070 Fax: (847) 699-7864

### TOKO AMERICA REGIONAL OFFICES

Midwest Regional Office  
Toko America, Inc.  
1250 Feehanville Drive  
Mount Prospect, IL 60056  
Tel: (847) 297-0070  
Fax: (847) 699-7864

Western Regional Office  
Toko America, Inc.  
2480 North First Street, Suite 260  
San Jose, CA 95131  
Tel: (408) 432-8281  
Fax: (408) 943-9790

Eastern Regional Office  
Toko America, Inc.  
107 Mill Plain Road  
Danbury, CT 06811  
Tel: (203) 748-6871  
Fax: (203) 797-1223

Semiconductor Technical Support  
Toko Design Center  
4755 Forge Road  
Colorado Springs, CO 80907  
Tel: (719) 528-2200  
Fax: (719) 528-2375

Visit our Internet site at <http://www.tokoam.com>

The information furnished by TOKO, Inc. is believed to be accurate and reliable. However, TOKO reserves the right to make changes or improvements in the design, specification or manufacture of its products without further notice. TOKO does not assume any liability arising from the application or use of any product or circuit described herein, nor for any infringements of patents or other rights of third parties which may result from the use of its products. No license is granted by implication or otherwise under any patent or patent rights of TOKO, Inc.