



L9473

## CAR ALTERNATOR VOLTAGE REGULATOR

### 1 FEATURES

- FOR AIR AND LIQUID COOLED APPLICATIONS
- AMBIENT AIR TEMPERATURE (THERMISTOR) COMPENSATED
- SPECIAL DEFAULT COMPENSATION CURVE WITH TS-TERMINAL OPEN
- COMPENSATION CURVE WITH APPLICATION SPECIFIC RESISTOR ON TS
- THERMAL PROTECTION
- FIELD DRIVER, LAMP DRIVER, RELAY DRIVER, AND DF (FIELD MONITOR) SHORT CIRCUIT PROTECTED
- LOAD RESPONSE CONTROL
- SINGLE PHASE AUTOSTART

### 2 DESCRIPTION

The L9484 is a monolithic multifunction generator

Figure 1. Package

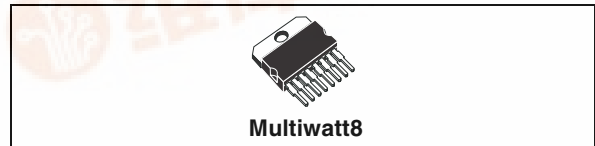

Table 1. Order Codes

Part Number	Package
L9473J	Multiwatt8

Voltage regulator intended for use in automotive charging applications.

This All Silicon Voltage Regulator regulates the output of an automotive generator by controlling the field winding current by means of a variable frequency PWM high side driver.

Figure 2. Block Diagram

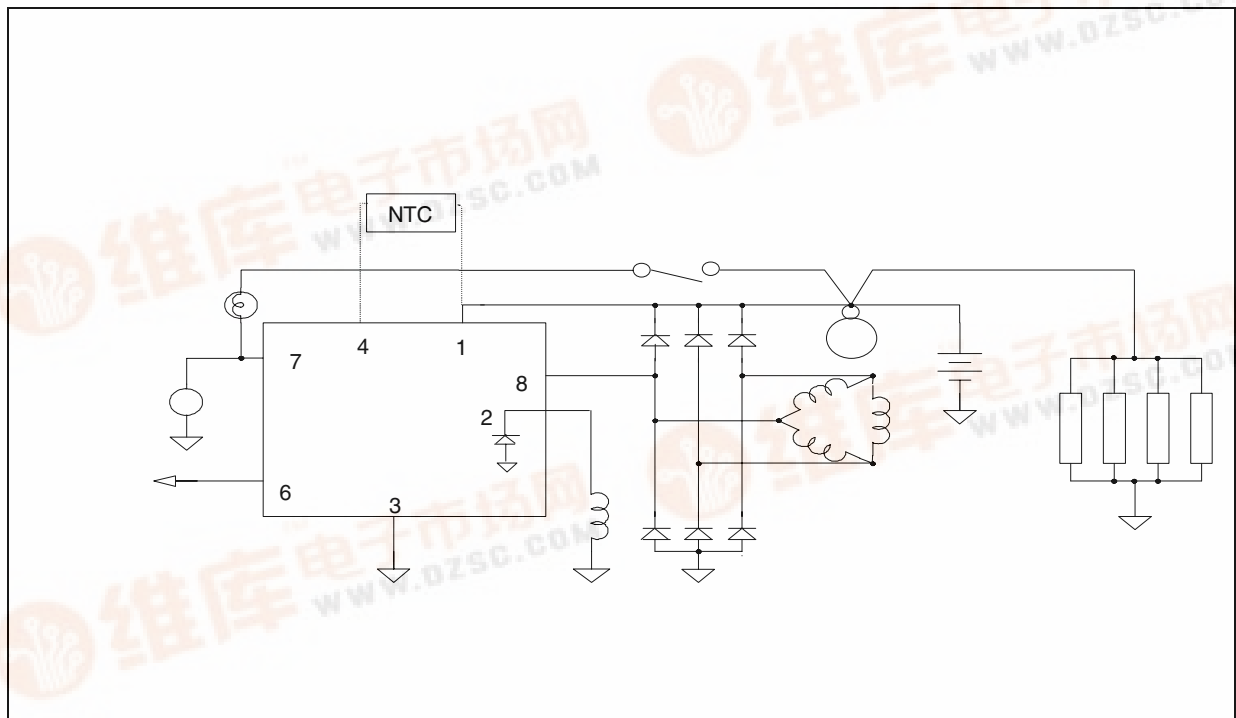

**Table 2. PIN DESCRIPTION**

N°	Pin	Description
1	V <sub>GO</sub>	Generator Output – Voltage Sense and Power Supply to ASVR
2	F+	Field Driver - High Side Drive Output
3	G	Ground for ASVR (Must be connected for Ground for ASVR)
4	TS	Thermistor Sense Terminal
5	Gnd	Internally connected to the Tab or Slug in MW-8. Shall not be used for ASVR Ground, nor voltage applied to Pin 5 to cause $\geq 50\text{mV}$ Pin 5 to Pin 3. May be unconnected or externally connected to Pin 3.
6	DF	Inverted Field Monitor Output
7	L	Lamp - Low Side Driver; Relay - High Side Driver
8	P	Phase Sense Input

**Figure 3. PIN CONNECTION (Top view)**

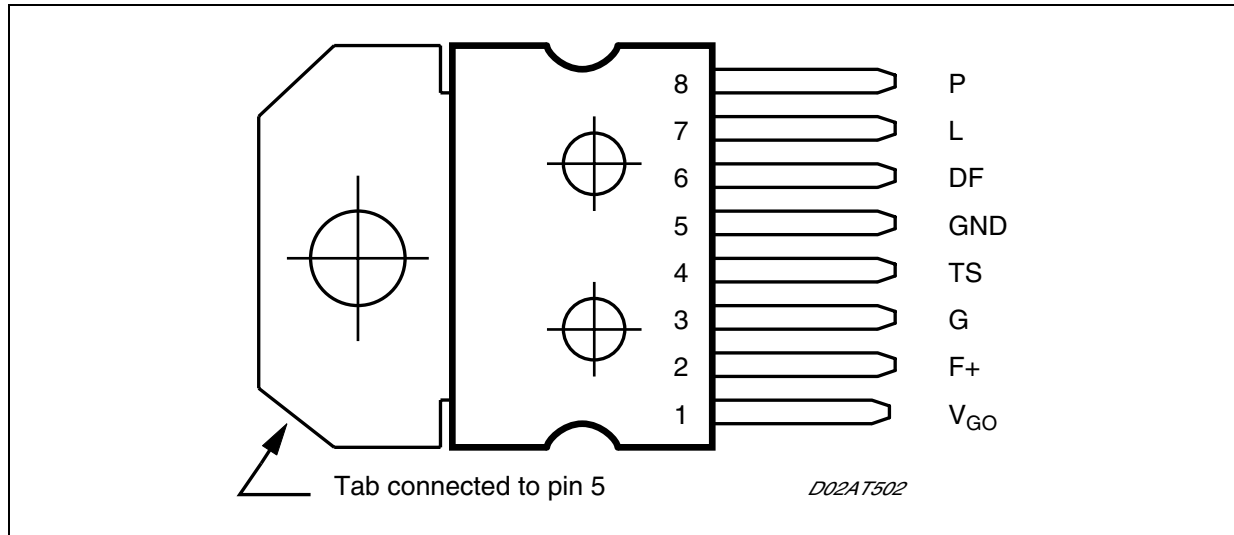

**Table 3. ABSOLUTE MAXIMUM RATINGS**

Symbol	Parameter	Value	Unit
	Output Current Capability	INTERNALLY LIMITED	A
	Power Dissipation	6	W
	Short Circuit Protected	All Terminal, to VGO and Ground	

**Table 4. THERMAL DATA**

Symbol	Parameter	Value	Unit
T <sub>j</sub>	Junction Temperature	-40 to +150	°C
T <sub>stg</sub>	Storage Temperature	-50 to +150	°C
T <sub>sd</sub>	Thermal Shut-Down	175 ± 15	°C
R <sub>th j-case</sub>	Thermal Resistance Junction to Case	1.5	°C/W

**Table 5. ELECTRICAL CHARACTERISTICS**(T<sub>case</sub> = -35°C to +150°C continuous unless otherwise specified)

Symbol	Parameter	Test Condition	Min.	Typ.	Max.	Unit
V <sub>OS</sub>	Operating Supply Voltage	T <sub>case</sub> = +25°C to +150°C	8		V <sub>ov</sub>	V
V <sub>OS</sub>	Operating Supply Voltage	T <sub>case</sub> = -40°C to +25°C	10		V <sub>ov</sub>	V
I <sub>SB</sub>	Stand-By Current	V <sub>GO</sub> = 12.6V; T <sub>case</sub> = 25°C; 10kΩ V <sub>GO</sub> to TS; F+, G & Tab (Slug) Grounded; L, DF, & P unconnected; Regulator NOT Activated.			300	μA
V <sub>SP</sub>	Regulator Set-Point	10kΩ between V <sub>GO</sub> and TS	Curve shown in Fig. 2			
V <sub>SP</sub>	Regulator Set-Point	NTC thermistor with R <sub>25°C</sub> = 10kΩ; T <sub>j</sub> = 90°C	Curves shown in Fig. 3 (with MURATA NTC NTH4G39A1)			
V <sub>NB</sub>	Generator Output, No Battery	No battery, I <sub>OUT</sub> = 2A to 50% Max. Load	V <sub>SP</sub> - 2		V <sub>SP</sub> + 2	V
T <sub>C</sub>	Thermal Compensation	Voltage @ V <sub>GO</sub>	Curves shown in Figs.4, 5			
V <sub>LR</sub>	Load Regulation	6500 grpm, 10% to 95% load			300	mV
V <sub>SR</sub>	Speed Regulation	15A load, 2000 to 20,000 grpm			100	mV
V <sub>F-ON</sub>	Output Saturation Voltage	I <sub>F</sub> = 6A, V <sub>GO</sub> = 14.0V, T <sub>case</sub> = 25°C			750	mV
V <sub>F-ON</sub>	Output Saturation Voltage	I <sub>F</sub> = 5A, V <sub>GO</sub> = 13.5V, T <sub>case</sub> = 125°C			850	mV
I <sub>F-LIM</sub>	Field Limit Current <sup>1</sup>	Current F+ Terminal to Gnd. @ T <sub>case</sub> ≤ 25°C	9.0			A
I <sub>F-LIM</sub>	Field Limit Current <sup>1</sup>	Current F+ Terminal to Gnd. @ T <sub>case</sub> = +150°C	6.0			A
I <sub>G-MIN</sub>	Min. Generator Current Load	Current measured @ generator output	0.5			A
V <sub>D-F</sub>	Field Discharge Diode	I <sub>F</sub> = 6A, T <sub>case</sub> = 25°C			1.85	V
I <sub>D-R</sub>	Diode Reverse Current	V <sub>R</sub> = 20V			1	mA
F <sub>OSC</sub>	Oscillation Frequency	During LRC operation	340	400	460	Hz
V <sub>DF</sub>	DF Saturation Voltage	I <sub>DF</sub> ≤ 10mA			0.8	V
I <sub>DF-LK</sub>	DF Output Leakage Current	V <sub>DF</sub> < 25V			10	μA
F <sub>TURBO</sub>	Internal Clock Frequency	V <sub>DF</sub> = 32 - 35V; thru 2.2kΩ		4X		Hz

Notes: 1. The Field Drive capability shall not decrease as a function of temperature between 25°C and 150°C, at a rate faster than -0.024A/°C (for example, Field Drive shall be capable of ≥7.2A at 100°C).

Figure 4. Set-Point Voltage vs. Mounting Tab Temperature (10kΩ between V<sub>GO</sub> & TS)

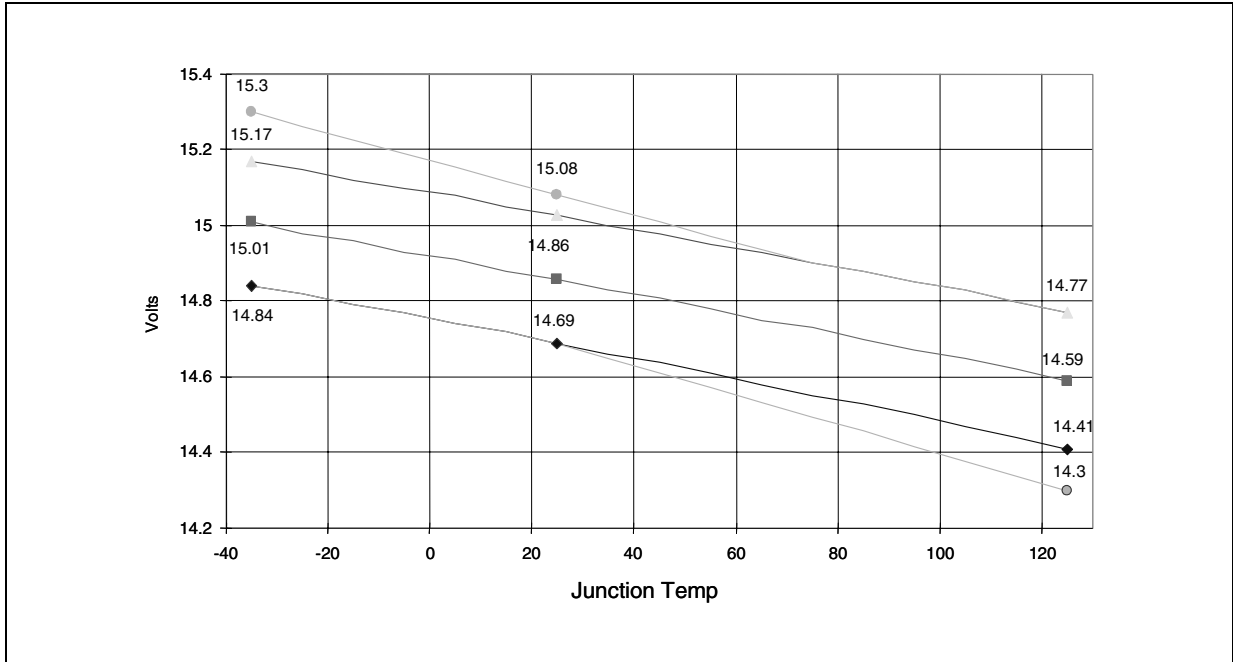

Figure 5. Set-Point Voltage vs. Thermistor Temperature, T<sub>j</sub> = 90°C (Not guaranteed by testing, depending on NTC characteristics)

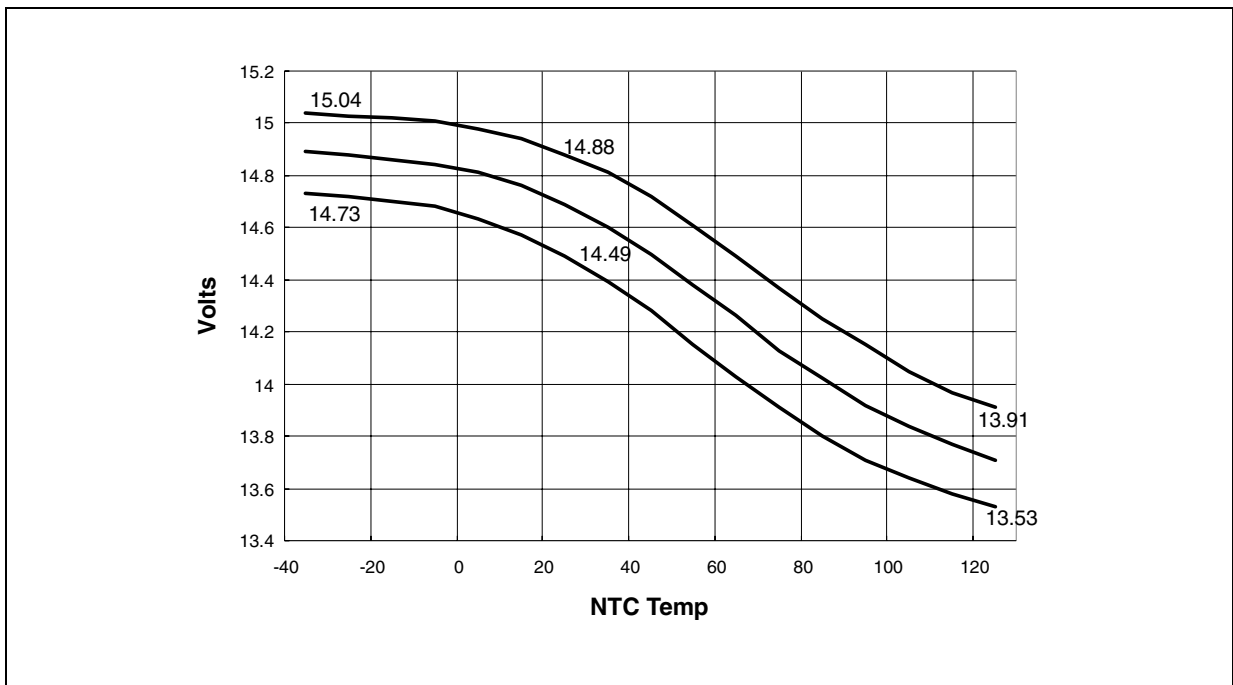
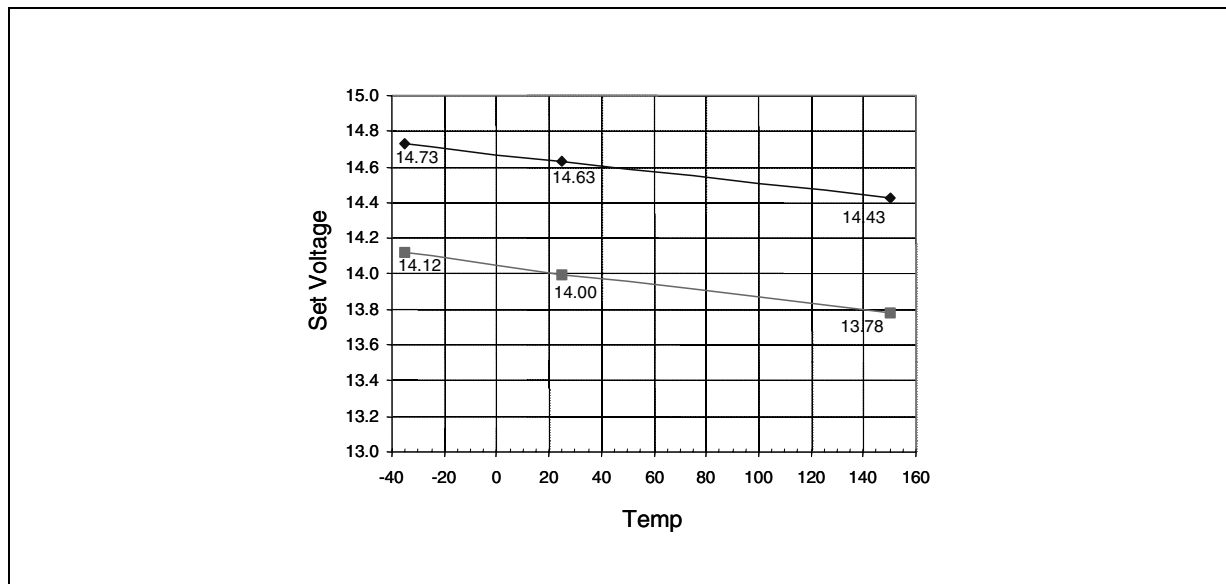

Figure 6. Set-Point Voltages vs. Mounting Tab Temperature (TS-Open)

Table 6. DIAGNOSTIC (T<sub>case</sub> = -35°C to +150°C unless otherwise specified)

Symbol	Parameter	Conditions	Min.	Typ.	Max.	Units
V <sub>OV</sub>	Over-Voltage		V <sub>SP</sub> + 1	V <sub>SP</sub> + 1.3	V <sub>SP</sub> + 2	V
V <sub>UV</sub>	Under-Voltage	F <sub>P</sub> > F <sub>P-LRC</sub> , 10kohm between S_term and V <sub>GO</sub>	10.95		11.8	V
V <sub>L-SAT</sub>	Lamp ON Saturation Voltage	I <sub>L</sub> = 0.5A (sunked by ASVR)	>V <sub>L-ACT</sub>	1.33	1.45	V
V <sub>L-SAT-BO</sub>	Lamp ON Voltage <sup>2</sup>	I <sub>L</sub> < 0.5A, V <sub>GO</sub> = Open; T <sub>case</sub> = -35°C to 85°C		3.8	5	V
V <sub>L-RLY</sub>	Lamp OFF (Relay Drive) Saturation Voltage (vs. B+)	I <sub>L</sub> = 750mA (Sourced by ASVR) <sup>3</sup> T <sub>case</sub> < 125C			1.85	V
T <sub>DELAY</sub>	Fault Indication Delay Time	Delay before Lamp ON	0.9	1.1	1.3	s

2. This condition can happen when the connection between the battery and V<sub>GO</sub> or the output terminal of the generator is broken. The 1.1 second delay is not required, and current is sunked by ASVR.
3. When no fault is detected the Lamp terminal is pulled up by ASVR.

Table 7. FAULT INDICATION TABLE

Conditions	T <sub>Delay</sub> ?
Initial KEY-ON Bulb and Wiring Check (Lamp ON for 1 sec ± 15% after initial KEY-ON)	No
V <sub>GO</sub> > V <sub>OV</sub>	Yes
V <sub>P</sub> < V <sub>P-F</sub> AND V <sub>GO</sub> < V <sub>SP</sub>	Yes
F <sub>P</sub> < F <sub>P-TR</sub> @ V <sub>P-TR</sub>	Yes
No Connection Between Battery and V <sub>GO</sub>	No
At Start: Lamp ON until F <sub>P</sub> > F <sub>P-IR</sub> AND V <sub>P</sub> > V <sub>P-F</sub> . i.e. until V <sub>P</sub> reaches 8V.	No

Table 8. REGULATION FEATURES

Symbol	Parameter	Conditions	Min.	Typ.	Max.	Unit
V <sub>L-PD</sub>	L Terminal Regulator Activate Threshold	V <sub>GO</sub> =12.6V	0.8	1	1.15	V
I <sub>L-PD</sub>	L Terminal Pull Down Current	V <sub>L</sub> = V <sub>L-ACT</sub> V <sub>GO</sub> =12.6V	0.09		0.78	mA
V <sub>P-IR</sub>	Initiate Regulation Phase Voltage Threshold	Regulator Activated	1.1	1.3	1.5	V
I <sub>P</sub>	Phase Terminal Current Sink	V <sub>P</sub> > 1.5V and < 12.6V V <sub>GO</sub> = 12.6V	0.25		3.5	mA
F <sub>P-IR</sub>	Initiate Regulation Phase Frequency		123	145	167	Hz
F <sub>P-TR</sub>	Terminate Regulation Phase Frequency		59	72	86	Hz
IRD	Initiate Regulation Delay	Regulator Activated, V <sub>P-IR</sub> AND F <sub>P-IR</sub> Conditions Met First Time.	2.5	3	3.5	s
FSDC	Field Strobe Duty Cycle	Regulator Activated AND (Regulation Terminated OR Regulation NOT Initiated)	16	18.75	22	%
LRC	Load Response Control Rate	Field Drive Duty Cycle Increase	8.5	10	11.5	%/s
F <sub>P-LRC</sub>	LRC Transition Frequency	LRC Enabled if F <sub>P</sub> < F <sub>P-LRC</sub>	255	300	345	Hz
SS	Soft-Start	LRC enabled until V <sub>SP</sub> reached regardless other conditions	34	40	46	%/s

Figure 7. Multiwatt 8 Mechanical Data &amp; Package Dimensions

DIM.	mm			inch		
	MIN.	TYP.	MAX.	MIN.	TYP.	MAX.
A			5			0.197
B			2.65			0.104
C			1.6			0.063
E	0.49		0.55	0.019		0.022
F	0.78		0.85	0.030		0.033
G	2.40	2.54	2.68	0.094	0.10	0.105
G1	17.64	17.78	17.92	0.69	0.70	0.71
H1	19.6			0.772		
H2			20.2			0.795
L	20.35		20.65	0.80		0.81
L2	17.05	17.20	17.35	0.67	0.68	0.68
L3	17.25	17.5	17.75	0.679	0.689	0.699
L4	10.3	10.7	10.9	0.406	0.421	0.429
L7	2.65		2.9	0.104		0.114
S	1.9		2.6	0.075		0.102
S1	1.9		2.6	0.075		0.102
U	0.40		0.55	0.015		0.022
Z	0.70		0.85	0.028		0.034
Dia1	3.65		3.85	0.144		0.152

### OUTLINE AND MECHANICAL DATA

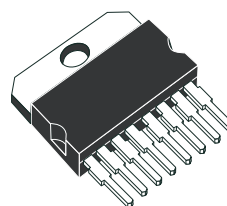

Multiwatt8 (Pin 5 GND)

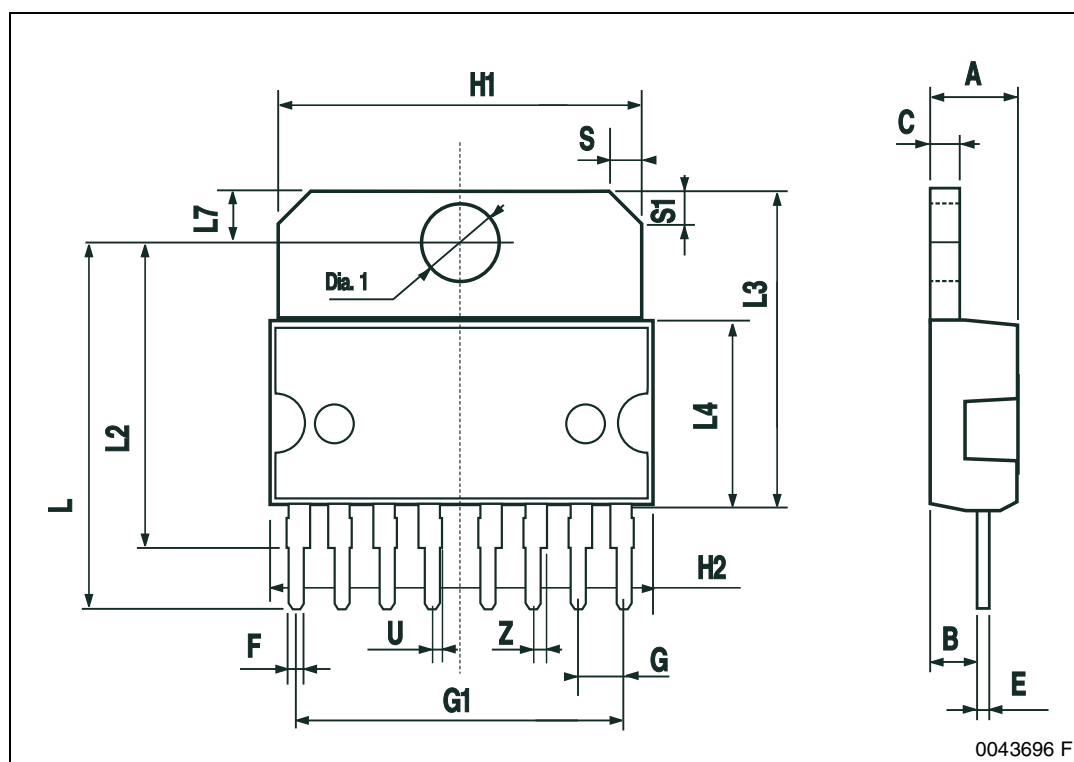

### 3 REVISION HISTORY

Table 9. Revision History

Date	Revision	Description of Changes
May 1994	1	First Issue



Information furnished is believed to be accurate and reliable. However, STMicroelectronics assumes no responsibility for the consequences of use of such information nor for any infringement of patents or other rights of third parties which may result from its use. No license is granted by implication or otherwise under any patent or patent rights of STMicroelectronics. Specifications mentioned in this publication are subject to change without notice. This publication supersedes and replaces all information previously supplied. STMicroelectronics products are not authorized for use as critical components in life support devices or systems without express written approval of STMicroelectronics.

The ST logo is a registered trademark of STMicroelectronics.  
All other names are the property of their respective owners

© 2005 STMicroelectronics - All rights reserved

STMicroelectronics group of companies

Australia - Belgium - Brazil - Canada - China - Czech Republic - Finland - France - Germany - Hong Kong - India - Israel - Italy - Japan -  
Malaysia - Malta - Morocco - Singapore - Spain - Sweden - Switzerland - United Kingdom - United States of America  
[www.st.com](http://www.st.com)