



The LA2010 is an IC for detecting interprogram spaces to pick out the starting point of a program immediately preceding or following a musical program recorded on tape.

Applicable Sets

- Radio-cassette recorders
- Cassette decks
- Car stereos

Application

- Detection of spaces between programs recorded on tape

Features

- Built-in transistor capable of driving plunger with 600 mA max. and protective diode to prevent induced reverse voltage
- Capable of desired timing setting by using external C, R
- Detects unrecorded areas of tape and drives plunger.
- Built-in preventer to prevent plunger from malfunctioning at the time of application of power
- Built-in detector to detect recorded area

Maximum Ratings/ $T_a = 25^\circ\text{C}$

			unit
Maximum supply voltage	V_{CC} max	15	V
Flow-in current	I_G max	600	mA
Allowable power dissipation	P_d max	540	mW
Operating temperature	T_{op}	$-20 \sim +75$	$^\circ\text{C}$
Storage temperature	T_{stg}	$-40 \sim +125$	$^\circ\text{C}$

- Note) • The voltage on pin 1 must not exceed the voltage on pin 9.
 • The current flowing into pin 2 and pin 4 must not exceed ± 0.5 mA continuously.
 • The voltage on pin 8 is 2.5 V max. and must not exceed the voltage on pin 7.

Operating Conditions/ $T_a = 25^\circ\text{C}$

			unit
Recommended supply voltage	V_{CC}	9	V
Operating voltage range	V_{CC} op	$3.5 \sim 14$	V

Package Dimensions 3017B-S9IC (unit: mm)

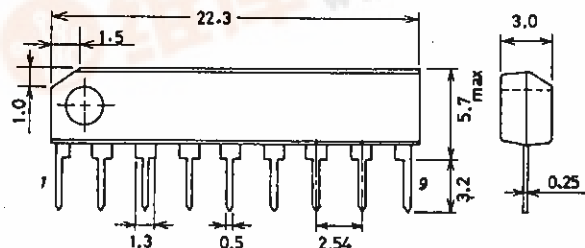

Operating Characteristics/ $T_a = 25^\circ\text{C}$, $V_{CC} = 9.0\text{ V}$, $f = 1\text{ kHz}$

			min	typ	max	unit
Circuit current	I_{CC}	$f = 1\text{ kHz}$, $V_{IN} = -30\text{ dB}$		11	22	mA
Output transistor saturation voltage	$V_{CE}(\text{sat})$	$I_B = 600\text{ mA}$		1.1	1.6	V
Output diode forward voltage	V_F	$I_F = 600\text{ mA}$		1.5	2.0	V
Input check level	V_{IN}	$f = 1\text{ kHz}$, Pin 6 L \rightarrow H	-47	-50	-53	dB
Comparator (1) ON level	V_{TH1-H}	Pin 6 inverted	3.0	3.5	4.0	V
Comparator (1) OFF level	V_{TH1-L}	Pin 6 inverted	1.8	2.2	2.6	V
Comparator (2) ON level	V_{TH2-H}	Pin 6 inverted	4.7	5.5	6.3	V
Comparator (2) OFF level	V_{TH2-L}	Pin 6 inverted	3.6	4.0	4.6	V
Pin 4 reset level	V_{4R}	$f = 1\text{ kHz}$, $V_{IN} = -30\text{ dB}$, pin 8 = 1.0 V		0.02	0.1	V
Pin 8 reset voltage-1	V_{8R-1}	Pin 1 inverted, $R_g = 0$	0.6	0.7	0.8	V
Pin 8 reset voltage-2	V_{8R-2}	$f = 1\text{ kHz}$, $V_{IN} = -30\text{ dB}$, pin 4 inverted	1.1	1.3	1.5	V

1. Description of external parts

- **C1:** Input coupling capacitor
Capacitor used for coupling with preceding preamp. Characteristics at the time of application of power considered, the capacitance value of C1 must not exceed that of C3 on pin 3. 0.047 μF (polyester film capacitor) is recommended. R1, R2 are used to adjust the input level. Pin 1 is high impedance; in order to be free from external effect, R2 must not exceed 10 kohm and must be grounded.

- **C2, R3:** For setting interprogram space detect time (T_D)
By selecting proper C2 and R3, your desired T_D can be obtained.
 $T_D = 1.34 \times C2 \cdot R3$ (sec)
It is recommended to use R3 of 150 kohm to 500 kohm.
It is recommended to use C2 of 0.22 μF (polyester film capacitor).

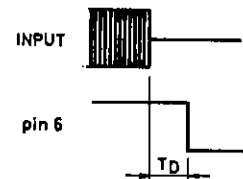

- **C3:** NF capacitor
Lower cut-off frequency f_L depends on this capacitor.

$$f_L = \frac{1}{0.3\pi C3 (\mu\text{F})} \dots \dots \dots (\text{kHz})$$

Assuming $C3 = 0.47\ \mu\text{F}$, $f_L = 2.2\text{ kHz}$ is obtained. If the capacitance value of C3 is increased, f_L lowers, thereby being subjected to the effect of the variations in preamp. Further, since the time that elapses between the moment V_{CC} is applied and the moment the circuit is stabilized becomes longer, the reset time must be made longer accordingly. Therefore, it is recommended to use C3 of 0.47 μF .

- **C4, R4:** For setting recorded area detect time (T_S)
The presence or absence of a program (input signal) is checked by the time setting determined by C4, R4 as follows:

- For recorded area $T_S < T_I + T_D$
- For unrecorded area $T_S > T_I + T_D$

The recorded area detect time is set by:

$$T_S = C4 (\mu\text{F}) R4 (\text{k}\Omega) (\text{msec})$$

Therefore, if the recorded area detect time (T_S) is longer than the input signal time (T_I) + the unrecorded area detect time (T_D), no program is present. The resistance value of R4 must be 50 kohm to 200 kohm; it is recommended to use R4 of 100 kohm. The capacitance value of C4 must not exceed 4.7 μF ; it is recommended to use C4 of 1 μF to 3.3 μF .

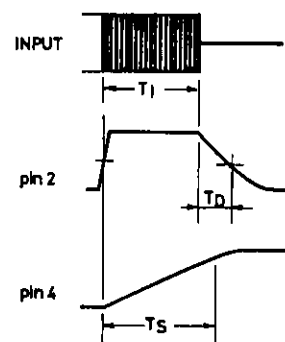

- C5: For setting reset time
Capacitor used to set the time for initializing the circuit at the time of application of power. The reset pulse is generated for a certain period of time [$TR = 14.4 \cdot C5 (\mu F) (ms)$] that is set each time power is applied.
- C6, R5: For power ripple filter

Description of Operation (See Timing Chart.)

When power is applied, the reset circuit operates to initialize the circuit. The reset time depends on the capacitance value of C5 on pin 8 and no input signal is accepted while the reset circuit is operating. When the reset mode is released and the input signal exceeds the input check level, C, R on pin 2 are charged and the potential on pin 2 rises, thereby causing the comparator (1) to be inverted. When the comparator (1) is inverted, pin 4 (C4) is charged and the potential on pin 4 begins rising. When this potential exceeds the threshold voltage, the comparator (2) is inverted and the program presence mode is memorized; thus the potential on pin 4 is held at High level. During this period of time, the output (pin 6) is held at High level. When the signal disappears and the comparator (1) is inverted, the output (pin 6) turns to Low level, thereby causing the plunger to be driven.

The reset pulse is generated for a certain period of time each time power is applied, thereby causing the circuit to be initialized.

Timing Chart

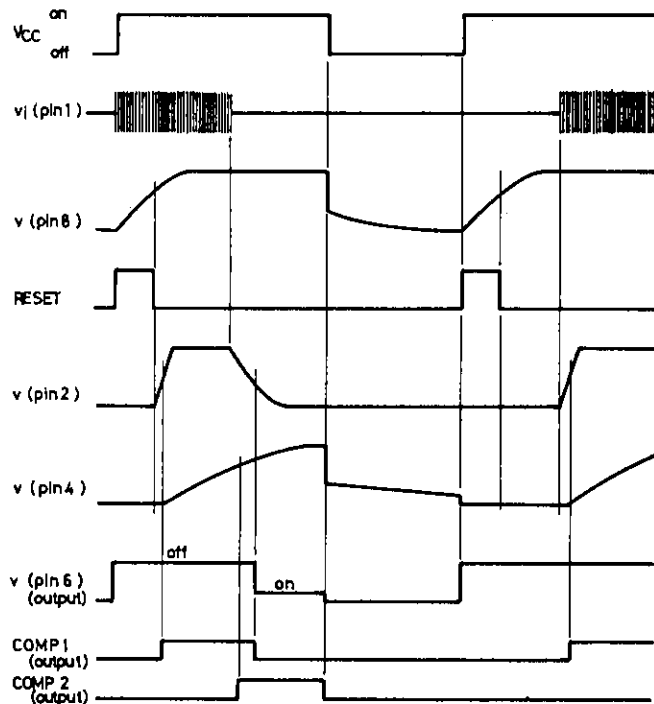

Proper Cares in Using IC

- Maximum Ratings
If the maximum ratings are exceeded, breakdown or deterioration may result. Use the IC in the range where the maximum ratings are not exceeded.
- Pin-to-pin Short and Inverted Insertion
These may cause breakdown or deterioration to occur. Be extremely careful when mounting the IC on the board.
- The voltage on pin 1 must not exceed that on pin 9.
- The current flowing into pin 2 and pin 4 must not exceed ± 0.5 mA continuously.
- The voltage on pin 8 is 2.5 V max. and must not exceed that on pin 7.
- Electrolytic capacitors are used to set the recorded area detect time and reset time. The actual time constants are 15 to 20 % larger than the calculated values obtained by using the catalog values of such capacitors. For polyester film capacitor and tantalum electrolytic capacitor, the calculated values hold to a fairly good approximation.

LA2010

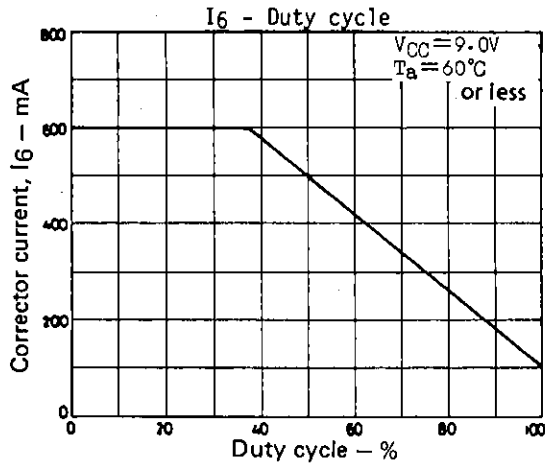

Note) Continuous application of I_C = 600 mA: Within 3 sec.

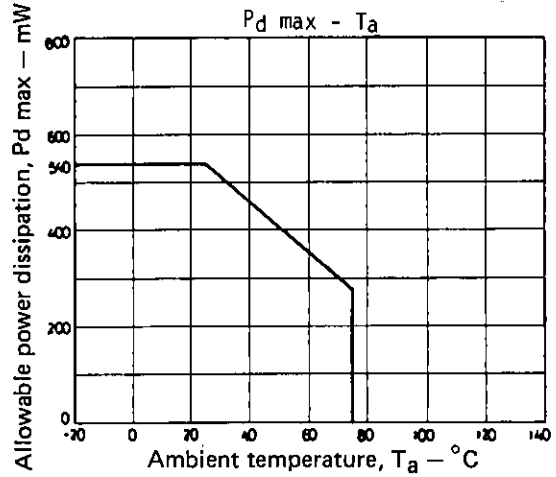

Test Circuit

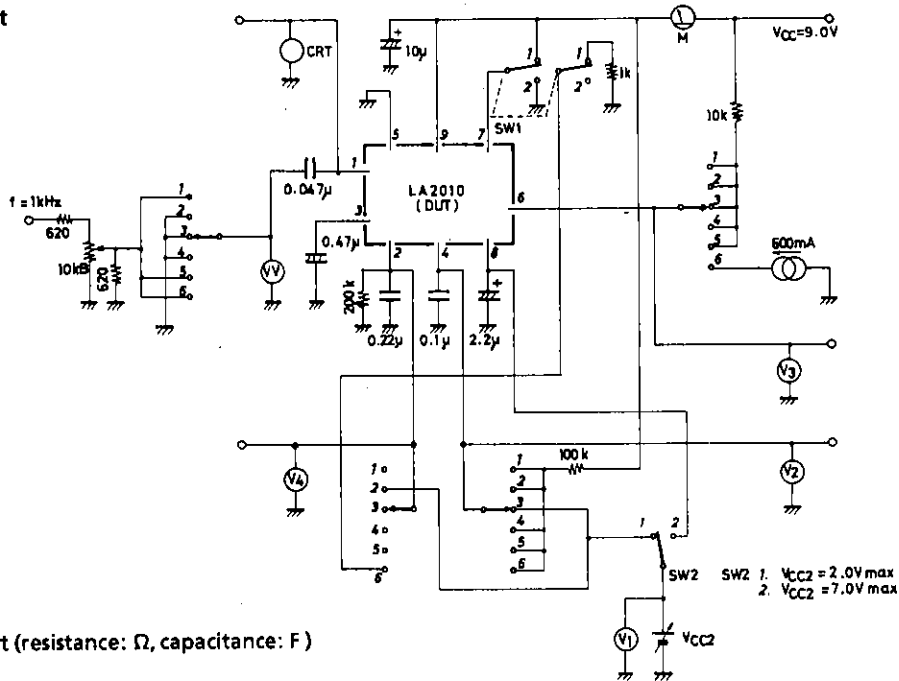

Unit (resistance: Ω, capacitance: F)

Test Item	Symbol	Rotary SW	SW-1	SW-2	Conditions
Input check level	V _{IN}	1	1	1	Measure AC input level VV at pin 6 L → H inversion mode.
Comparator (1) ON level	V _{TH1-H}	2	1	1	Measure pin 2 V ₄ at pin 6 L → H inversion mode.
Comparator (1) OFF level	V _{TH1-L}	2	1	1	Measure pin 2 V ₄ at pin 6 H → L inversion mode.
Comparator (2) ON level	V _{TH2-H}	3	1	1	Measure pin 4 V ₂ at pin 6 H → L inversion mode.
Comparator (2) OFF level	V _{TH2-L}	3	1	1	Measure p-n 4 V ₂ at pin 6 L → H inversion mode.
Pin 8 reset voltage 1	V _{BR-1}	4	1	2	Measure V ₁ voltage at pin 1 inversion mode.
Pin 8 reset voltage 2	V _{BR-2}	5	1	2	Measure V ₁ voltage at pin 4 inversion mode.
Pin 4 reset level	V _{4R}	5	1	2	Measure pin 4 voltage V ₂ at V ₁ = 1V.
Circuit current	I _{CC}	5	1	1	Measure supply current.
Output transistor saturation voltage	V _{CE (sat)}	6	1	1	Measure pin 6 voltage V ₃ at 600 mA.
Output diode saturation voltage	V _F	6	2	1	Measure pin 6 voltage V ₃ at 600 mA.

LA2010

Equivalent Circuit Block Diagram

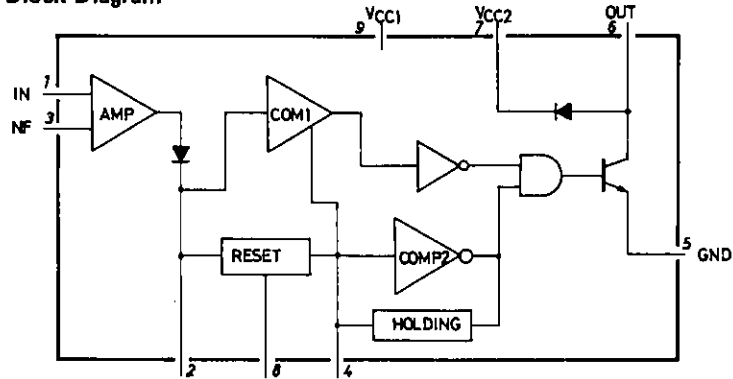

Sample Application Circuit

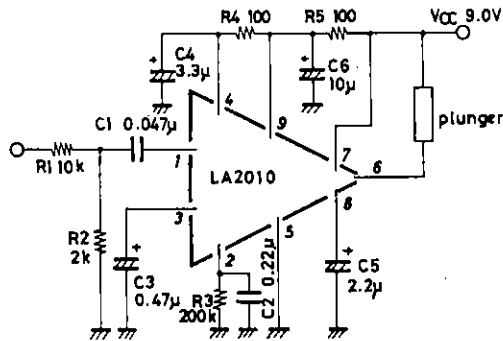

Unit (resistance: Ω , capacitance: F)

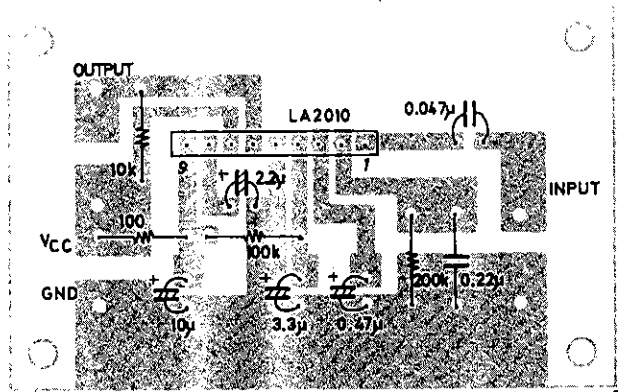

Sample Printed Circuit Pattern
(Cu-foiled area)

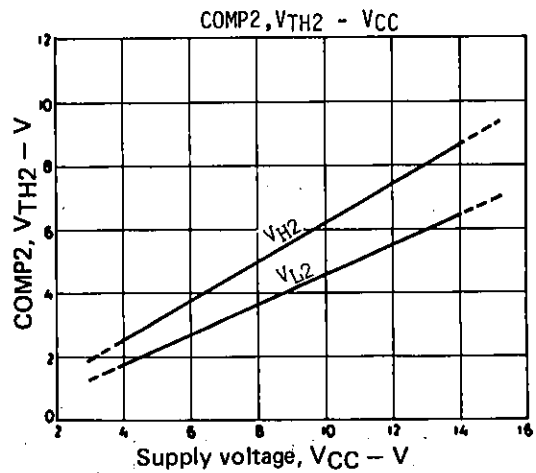
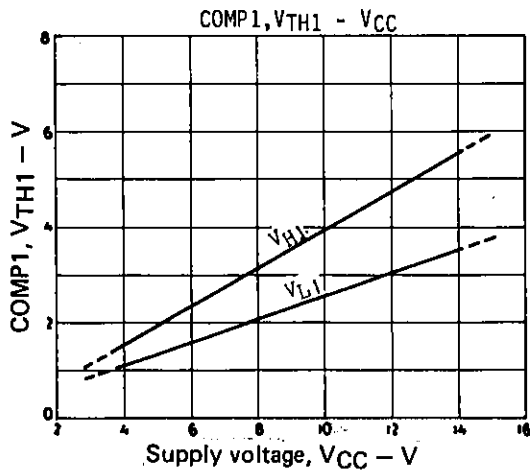

Unit (resistance: Ω , capacitance: F)

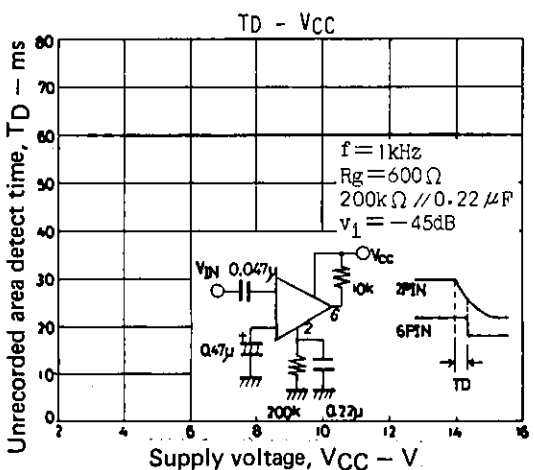
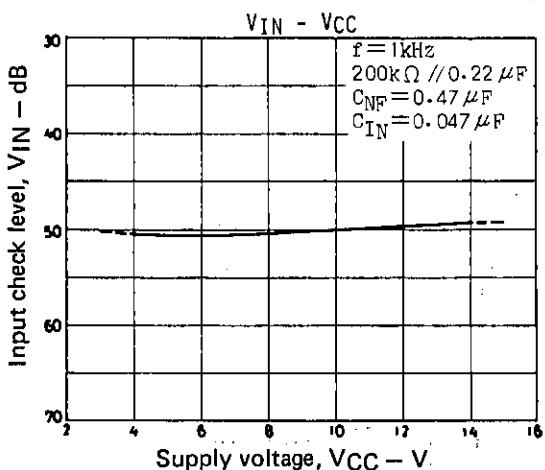
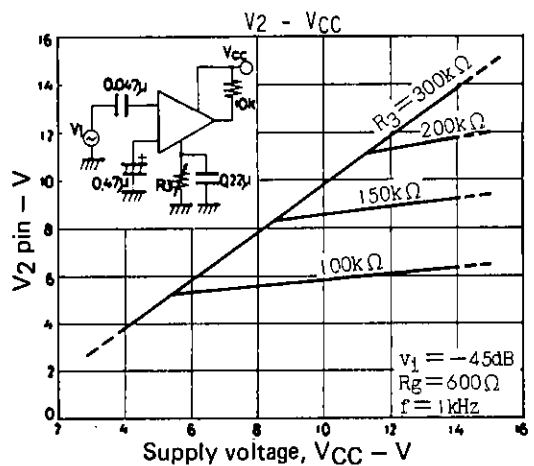
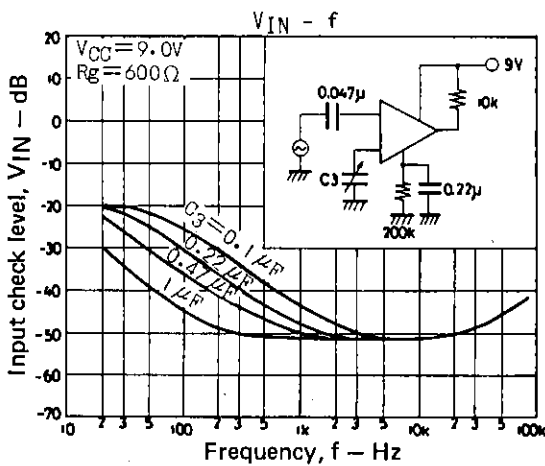
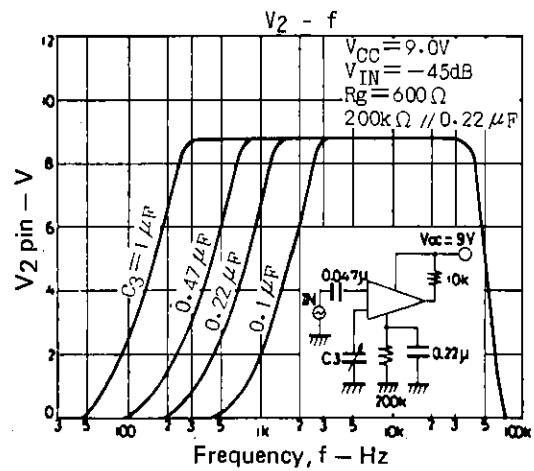
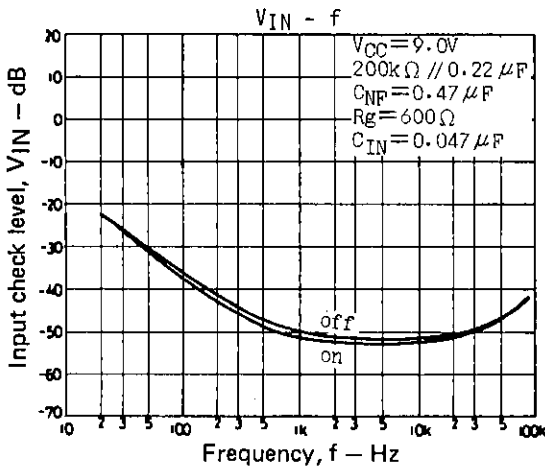
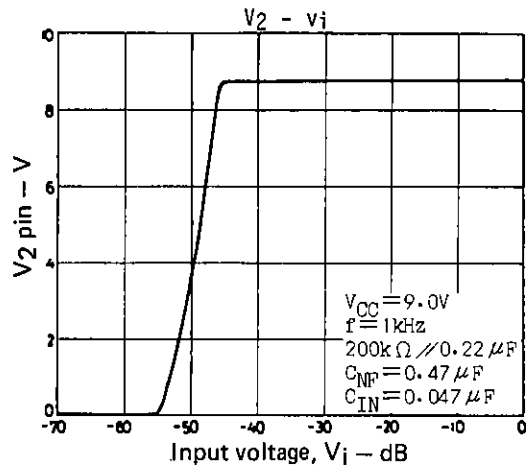
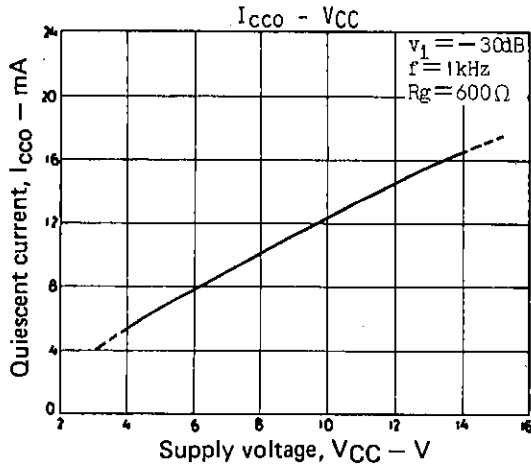

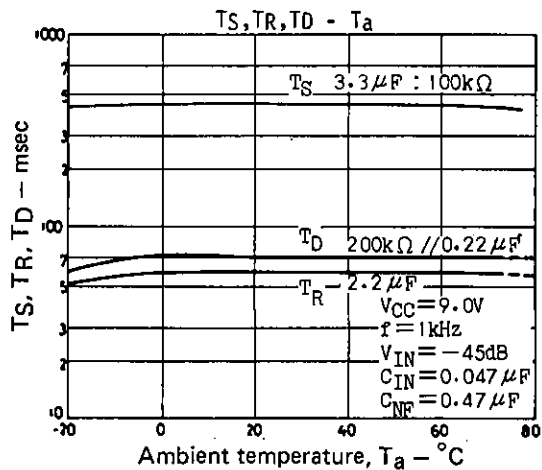
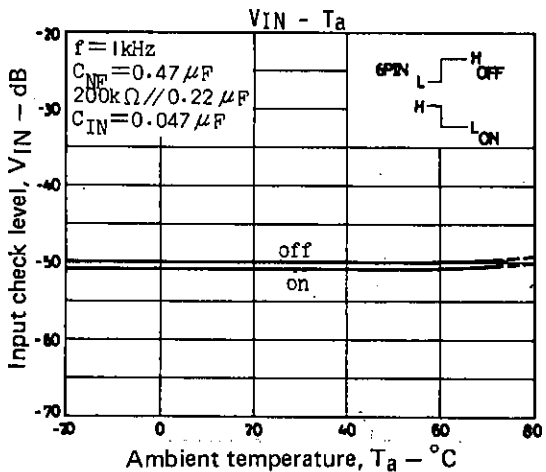
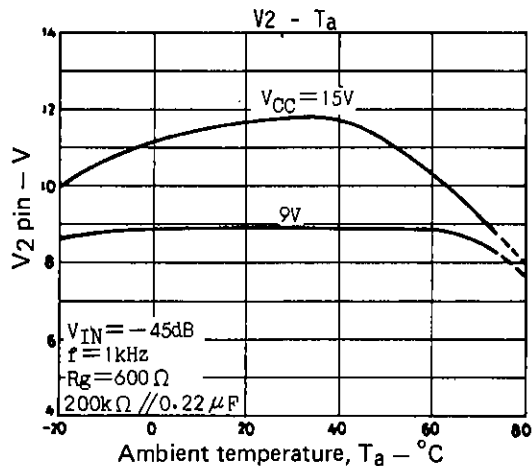
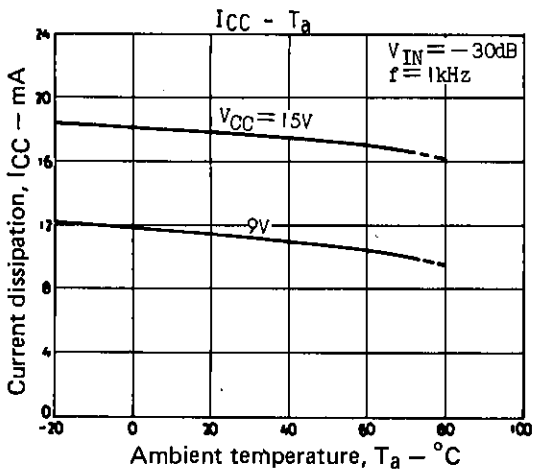
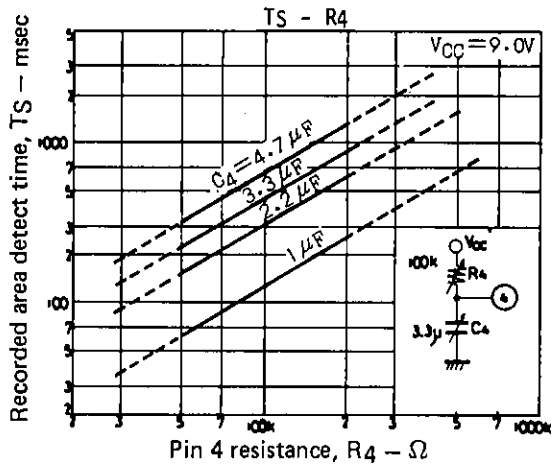
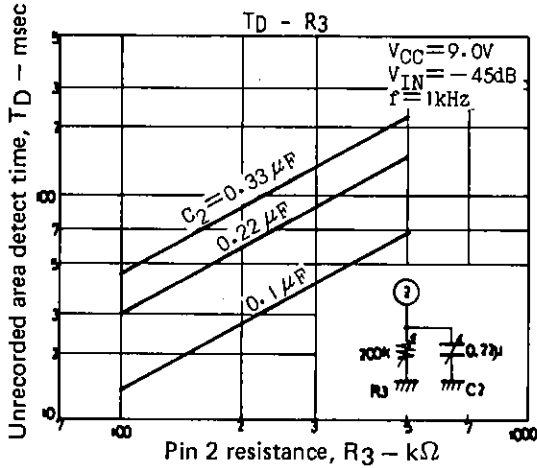
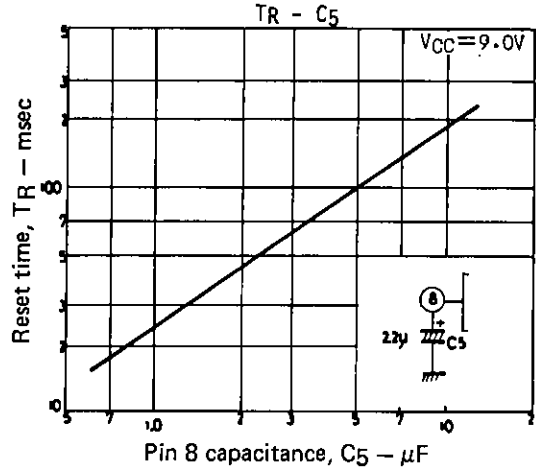
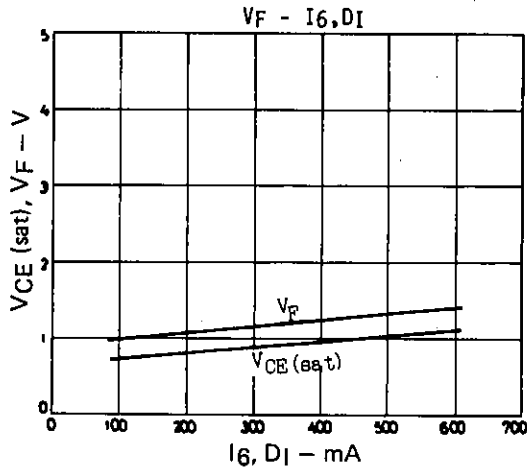

- No products described or contained herein are intended for use in surgical implants, life-support systems, aerospace equipment, nuclear power control systems, vehicles, disaster/crime-prevention equipment and the like, the failure of which may directly or indirectly cause injury, death or property loss.
- Anyone purchasing any products described or contained herein for an above-mentioned use shall:
 - ① Accept full responsibility and indemnify and defend SANYO ELECTRIC CO., LTD., its affiliates, subsidiaries and distributors and all their officers and employees, jointly and severally, against any and all claims and litigation and all damages, cost and expenses associated with such use;
 - ② Not impose any responsibility for any fault or negligence which may be cited in any such claim or litigation on SANYO ELECTRIC CO., LTD., its affiliates, subsidiaries and distributors or any of their officers and employees jointly or severally.
- Information (including circuit diagrams and circuit parameters) herein is for example only; it is not guaranteed for volume production. SANYO believes information herein is accurate and reliable, but no guarantees are made or implied regarding its use or any infringements of intellectual property rights or other rights of third parties.