

Ordering number: ENN7096

Monolithic Linear IC



# LA4278

## 10 W 2-Channel Power Amplifier

### Overview

The LA4278 is a 10 W 2-channel power amplifier intended for televisions.

This IC has a series of pin compatible monaural and 2-channel power amplifiers, thus allows the end product to use a common circuit board.

### Features

- Television audio output.
- Pin compatible with the LA4266 (3 W)/LA4267 (5 W)/4268 (10 W) and the LA4276 (3 W × 2)/4277(5 W × 2).
- Package: SIP-10H (2.54 mm pitch, straight pins).
- Thermal protection circuit and overvoltage protection circuit on chip.
- Output power: 10 W × 2 ( $V_{CC} = 28 \text{ V}/R_L = 8 \Omega$ ).

### Package Dimensions

unit: mm

#### 3024A-SIP10H

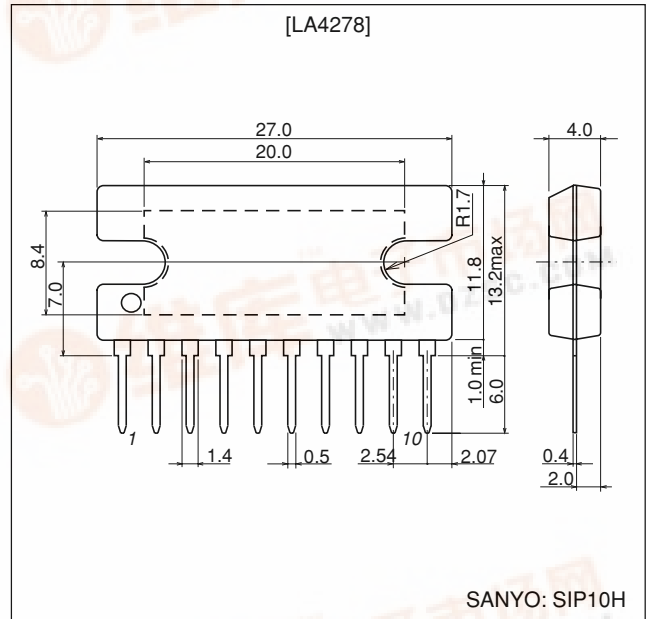

### Specifications

Maximum Ratings at  $T_a = 25^\circ\text{C}$

Parameter	Symbol	Conditions	Ratings	Unit
Maximum supply voltage	$V_{CC}$	$R_g = 0$	35	V
Maximum output current	$I_O \text{ peak}$	Per channel	2.5	A
Allowable power dissipation	$P_d \text{ max}$	Infinite heat sink	25.0	W
Thermal resistance	$\theta_{j-c}$		3.0	$^\circ\text{C}/\text{W}$
Operating temperature	$T_{opr}$		-20 to +75	$^\circ\text{C}$
Storage temperature	$T_{stg}$		-40 to +150	$^\circ\text{C}$

Operating Conditions at  $T_a = 25^\circ\text{C}$

Parameter	Symbol	Conditions	Ratings	Unit
Recommended supply voltage	$V_{CC}$		28	V
Load resistance	$R_L$		8	$\Omega$
Operating supply voltage range	$V_{CC \text{ op}}$	Range does not exceed $P_d$	10 to 34	V

- Any and all SANYO products described or contained herein do not have specifications that can handle applications that require extremely high levels of reliability, such as life-support systems, aircraft's control systems, or other applications whose failure can be reasonably expected to result in serious physical and/or material damage. Consult with your SANYO representative nearest you before using any SANYO products described or contained herein in such applications.
- SANYO assumes no responsibility for equipment failures that result from using products at values that exceed, even momentarily, rated values (such as maximum ratings, operating condition ranges, or other parameters) listed in products specifications of any and all SANYO products described or contained herein.



## LA4278

**Operating Characteristics** at  $T_a = 25^\circ\text{C}$ ,  $V_{CC} = 28\text{ V}$ ,  $R_L = 8\ \Omega$ ,  $f = 1\text{ kHz}$ ,  $R_g = 600\ \Omega$ , with specified board, in specified circuit

Parameter	Symbol	Conditions	Ratings			Unit
			min	typ	max	
Quiescent current	$I_{CCO}$	$R_g = 0$		55	80	mA
Voltage gain	VG	$V_O = 0\text{ dBm}$	38	40	42	dB
Total harmonic distortion	THD	$P_O = 0.5\text{ W}$		0.1	0.8	%
Output noise voltage	$V_{NO}$	$R_g = 10\text{ k}\Omega$ , BPF = 20 Hz to 20 kHz		0.25	1.0	mV
Output power	$P_O$	THD = 10 %	8.0	10		W
Ripple rejection	SVRR	$R_g = 0$ , $f_r = 100\text{ Hz}$ , $V_r = 0.5\text{ Vrms}$	45	55		dB
Crosstalk	CT	$R_g = 10\text{ k}\Omega$ , $V_O = 0\text{ dBm}$	40	55		dB

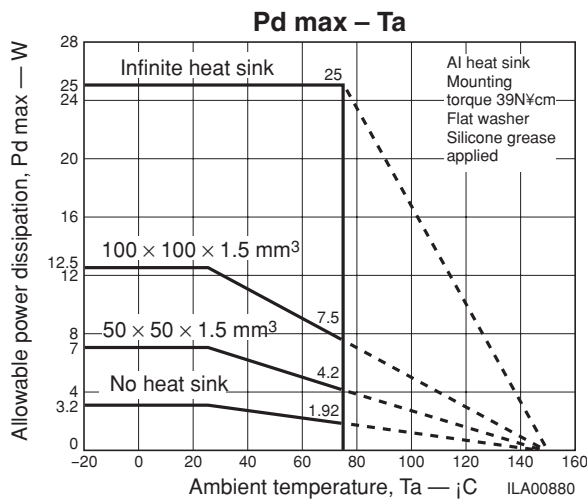

### Pin Assignment and Equivalent Circuit Diagram

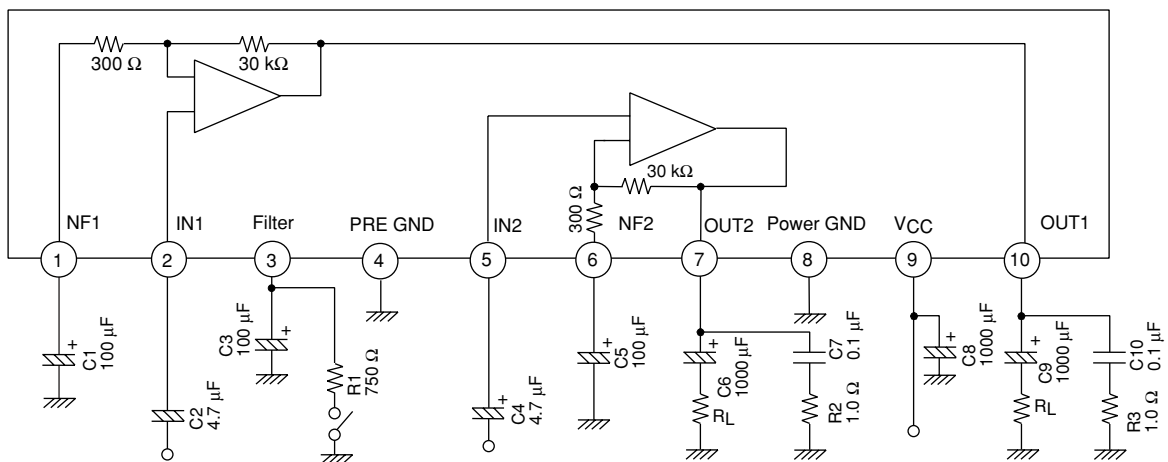

\* For Muting, add a resistor between pin 3 and GND. 750  $\Omega$  for the LA4266/67/68, 200  $\Omega$  for the LA4276/77.

**Description of External Parts**

C1, C5: Feedback capacitors

Decreasing the capacitance value lowers the low frequency response. Increasing the capacitance value makes the starting time later.

C2, C4: Input capacitors

Because the DC potential of the input pin is not zero, this capacitor can not be omitted. Decreasing the capacitance value to an extremely low level lowers the low frequency response.

C3: Ripple filter capacitor

Decreasing the capacitance value reduces ripple rejection. This capacitor also affects the starting time; decreasing the capacitance value makes the starting time earlier.

C6, C9: Output capacitors

Decreasing the capacitance value causes insufficient power at low frequencies.

C7, C10: Oscillation blocking capacitors

Decreasing the capacitance value causes oscillation to occur easily. Use a mylar film capacitor that has good high frequency response and temperature characteristics. The use of an electrolytic capacitor or a ceramic capacitor may cause oscillation to occur at low temperatures.

C8: Power capacitor

Decreasing the capacitance value causes ripple to occur easily. Locating this capacitor at a distance from the IC or removing this capacitor may cause oscillation to occur.

R1: Muting resistor

Refer to supplementary discussion “External Muting.”

R2, R3: Resistors connected in series with oscillation blocking capacitor

These prevent phase shift in conjunction with the oscillation blocking capacitor so that oscillation does not easily occur. There is an optimal value for the resistor; increasing or decreasing the resistance causes oscillation to occur easily.

**External Muting**

- Pull down the electric potential of the ripple filter pin (pin 3).

Muting becomes possible by inserting the discharge resistor R3 between pin 3 and GND. If the resistance value of R3 is too low, a popping noise is generated; if the resistance value is too high, the muting effect is reduced. (A value of 750 Ω is recommended for R3.)

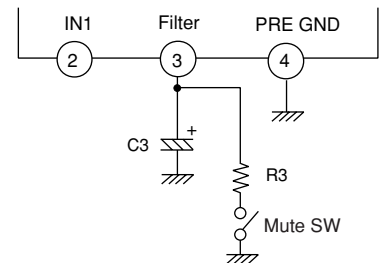

**Voltage Gain**

The voltage gain is fixed at 40dB by the ratio of the 30 kΩ and 300 Ω internal resistors. Therefore, it is not possible to use this IC with a voltage gain greater than 40 dB. Although it is possible to use this IC with a voltage gain of less than 40 dB by adding a feedback resistor (RNF) and external resistors (R) as shown in the diagram, doing so causes oscillation to occur easily. Therefore, do not use this IC with a voltage gain of 30dB or less.

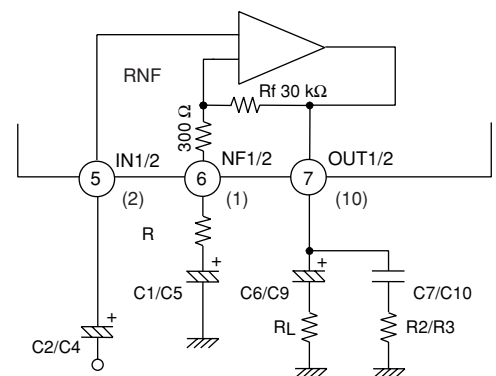

### Notes on Using the IC

- **Maximum ratings**  
When this IC is used near its maximum ratings, it is possible that a slight fluctuation in the operating conditions could cause the maximum ratings to be exceeded, damaging the IC. Therefore, allow for an adequate safety margin in regards to supply voltage, etc., so that the IC is never used under conditions that exceed its maximum ratings.
- **Short circuit between pins**  
Applying power to the IC while a short circuit exists between two pins can cause damage or deterioration in the IC. Therefore, after mounting the IC on a board, make sure that there are no solder bridges, etc., causing a short circuit between any of the pins before applying power to the IC.
- **Using the IC in a radio**  
When using this IC in a radio, make sure that there is enough distance between the IC and the bar antenna.
- **Printed circuit pattern**  
When designing the printed circuit pattern, keep power, output, and ground lines thick and short, and determine the placement of the pattern and the components in such a way as to prevent the generation of an I/O feedback loop. In addition, power supply capacitor C8 and oscillation blocking capacitor C7 and C10 should be placed as close as possible to the IC pins in order to prevent oscillation.

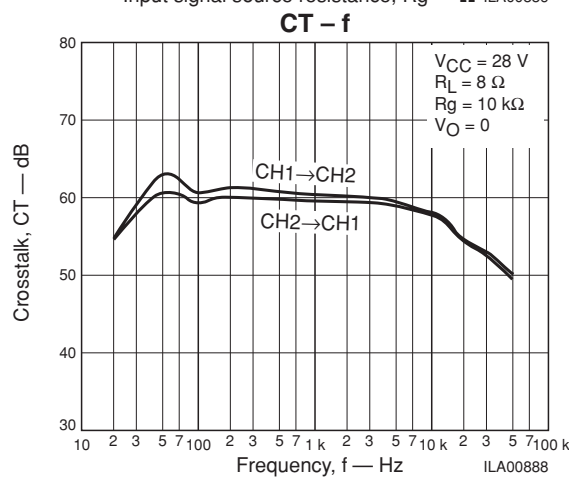
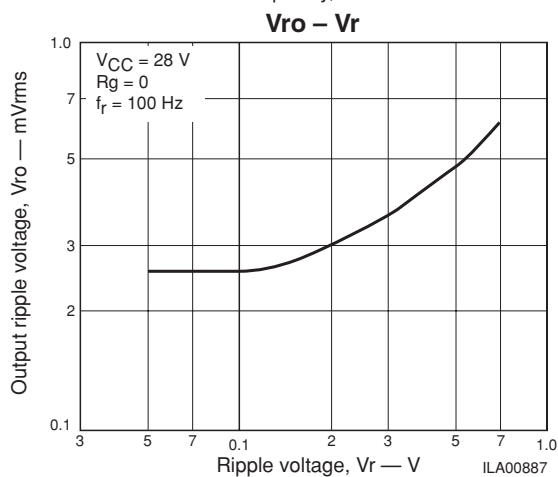
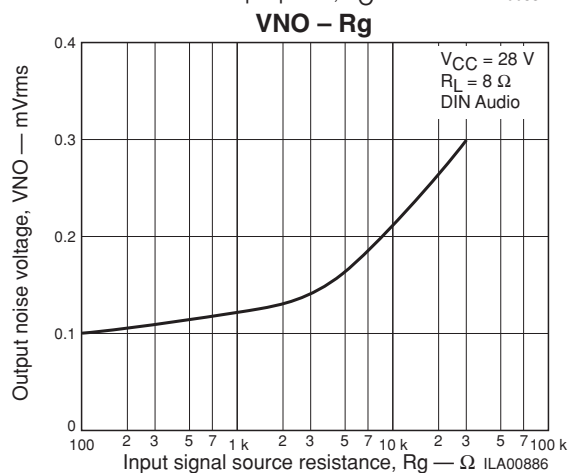
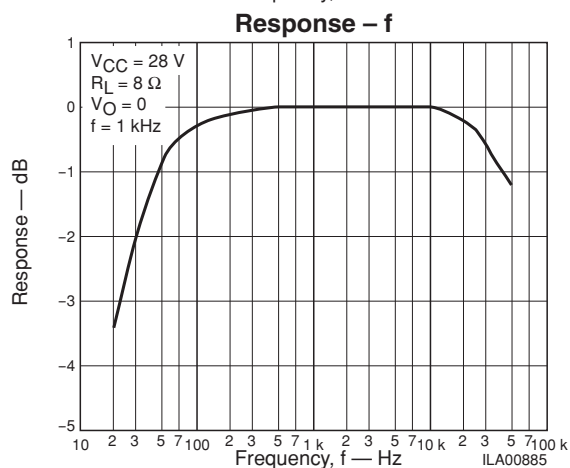
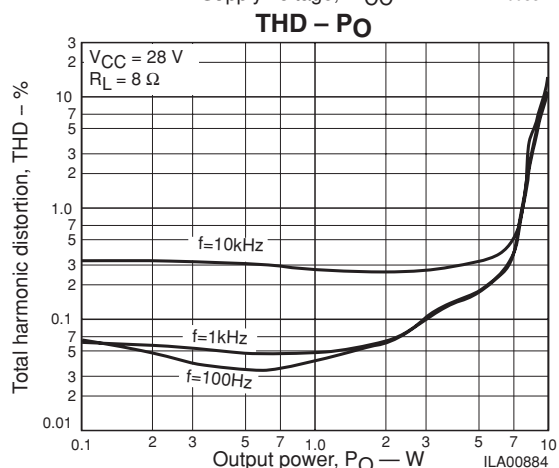
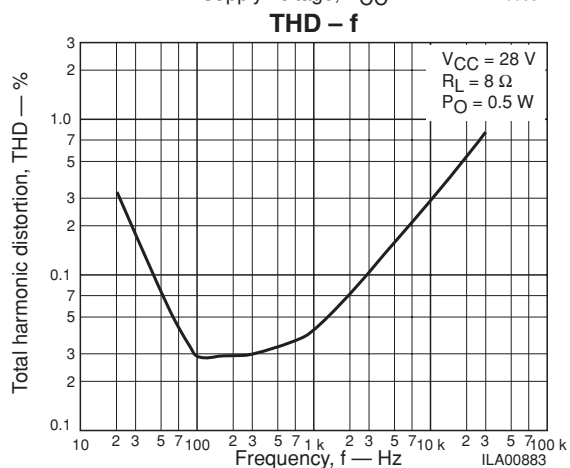
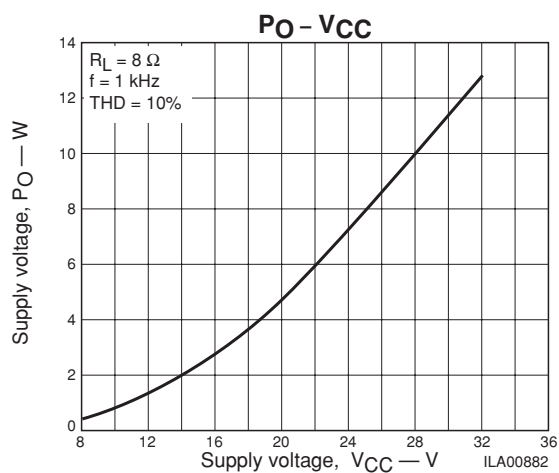
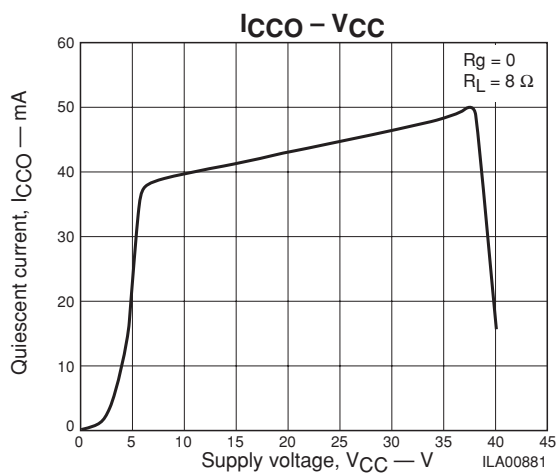

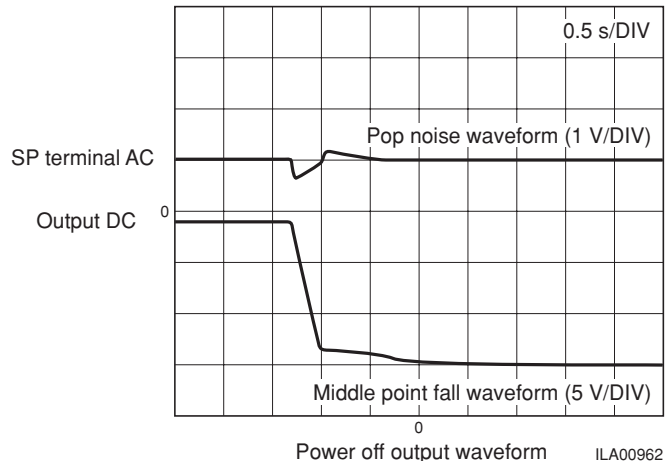
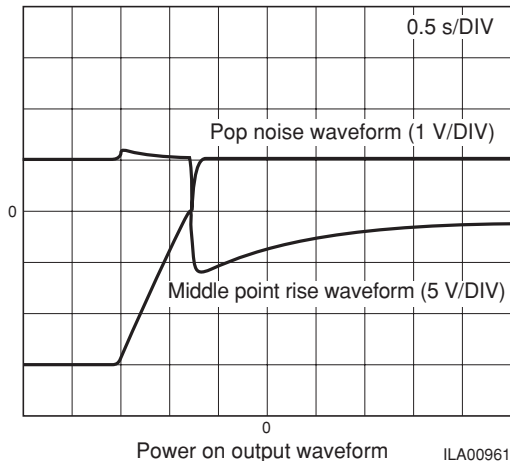
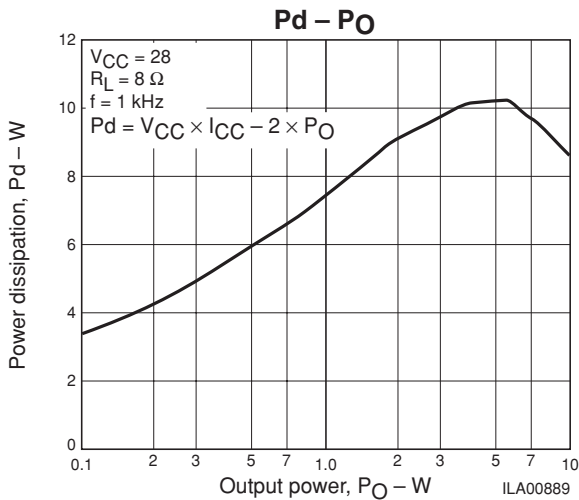

- Specifications of any and all SANYO products described or contained herein stipulate the performance, characteristics, and functions of the described products in the independent state, and are not guarantees of the performance, characteristics, and functions of the described products as mounted in the customer's products or equipment. To verify symptoms and states that cannot be evaluated in an independent device, the customer should always evaluate and test devices mounted in the customer's products or equipment.
- SANYO Electric Co., Ltd. strives to supply high-quality high-reliability products. However, any and all semiconductor products fail with some probability. It is possible that these probabilistic failures could give rise to accidents or events that could endanger human lives, that could give rise to smoke or fire, or that could cause damage to other property. When designing equipment, adopt safety measures so that these kinds of accidents or events cannot occur. Such measures include but are not limited to protective circuits and error prevention circuits for safe design, redundant design, and structural design.
- In the event that any or all SANYO products (including technical data, services) described or contained herein are controlled under any of applicable local export control laws and regulations, such products must not be exported without obtaining the export license from the authorities concerned in accordance with the above law.
- No part of this publication may be reproduced or transmitted in any form or by any means, electronic or mechanical, including photocopying and recording, or any information storage or retrieval system, or otherwise, without the prior written permission of SANYO Electric Co., Ltd.
- Any and all information described or contained herein are subject to change without notice due to product/technology improvement, etc. When designing equipment, refer to the "Delivery Specification" for the SANYO product that you intend to use.
- Information (including circuit diagrams and circuit parameters) herein is for example only; it is not guaranteed for volume production. SANYO believes information herein is accurate and reliable, but no guarantees are made or implied regarding its use or any infringements of intellectual property rights or other rights of third parties.