



No.2681B

Monolithic Linear IC

LA4597

2-Channel Power Amp for Radio-Cassette Recorders

Functions

- On-chip thermal shutdown circuit
- On-chip standby switch

Maximum Ratings at Ta = 25°C

Parameter	Symbol	Value	unit
Maximum Supply Voltage	V _{CC} max	18	V
Allowable Power Dissipation	P _d max	With 100×100×1.5mm ³ Al heat sink	11.4 W
Operating Temperature	T _{opr}	-20 to +75	°C
Storage Temperature	T _{stg}	-40 to +150	°C

Operating Conditions at Ta = 25°C

Parameter	Symbol	Value	unit
Recommended Supply Voltage	V _{CC}	9, 12	V
Recommended Load Resistance	R _L	3.2	Ω
Operating Voltage Range	V _{CC op}	4.2 to 16.0	V

Operating Characteristics at Ta = 25°C, V_{CC} = 9V, f = 1kHz, R_g = 600Ω, R_L = 3.2Ω, V_G = 50dB

Parameter	Symbol	Condition	min	typ	max	unit
Quiescent Current	I _{cco}		10	20	40	mA
Voltage Gain	V _G		47	49	51	dB
Output Power (1)	P _{o1}	THD = 10%	2.2	2.9		W
Output Power (2)	P _{o2}	THD = 10%, V _{CC} = 12V		4.6		W
Total Harmonic Distortion	THD	V _o = 2V		0.3	1.0	%
Input Resistance	r _i		20	30		kΩ
Output Noise Voltage	V _{NO1}	R _g = 0, B.P.F. = 20Hz to 20kHz		0.4	1.0	mV
	V _{NO2}	R _g = 10kΩ, B.P.F. = 20Hz to 20kHz		0.6	2.0	mV
Ripple Rejection	R _r	R _g = 0, f _r = 100Hz, V _{CCR} = 150mV	40	50		dB
Channel Separation	CH Sep	R _g = 10kΩ, V _o = 0dB	45	55		dB
Standby Current	I _{sd}				10	μA

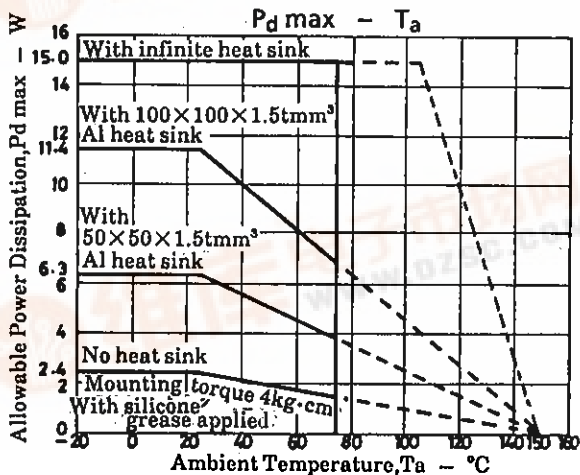

Package Dimensions (unit: mm)
3107

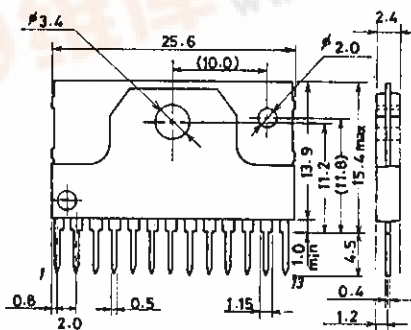

SANYO: SIP13H



Test Circuit and External Constants

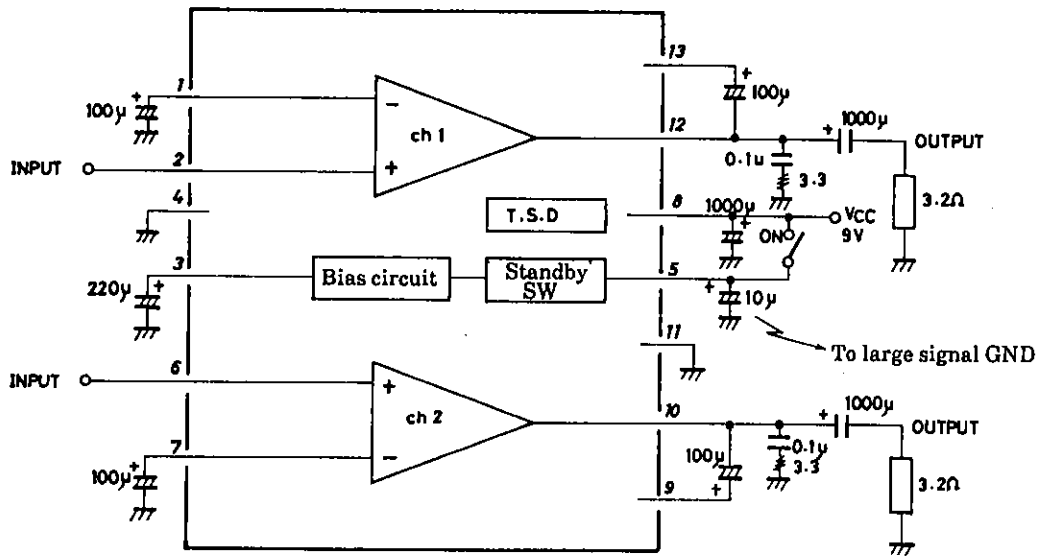

Unit (resistance: Ω , capacitance: F)

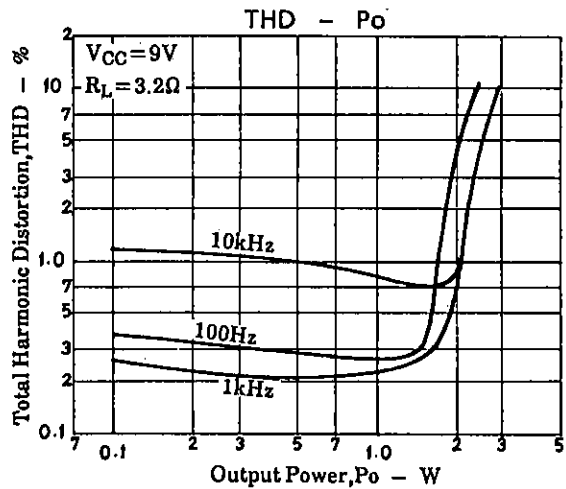
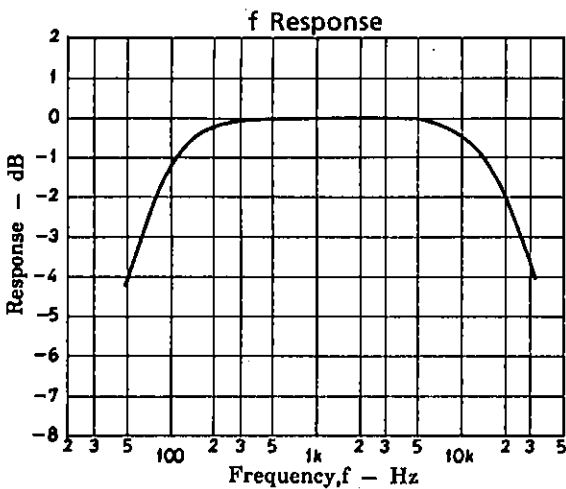
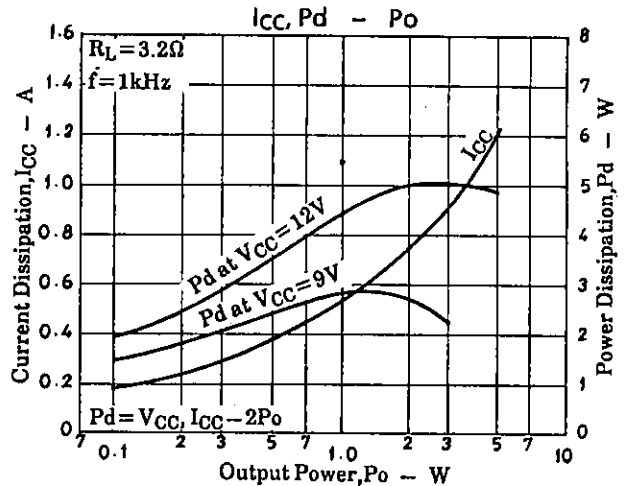
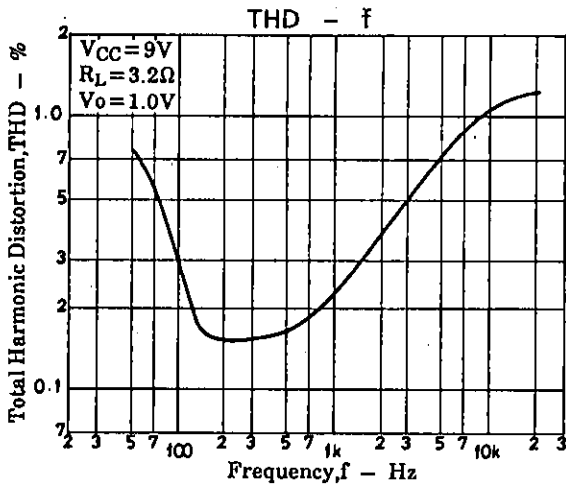

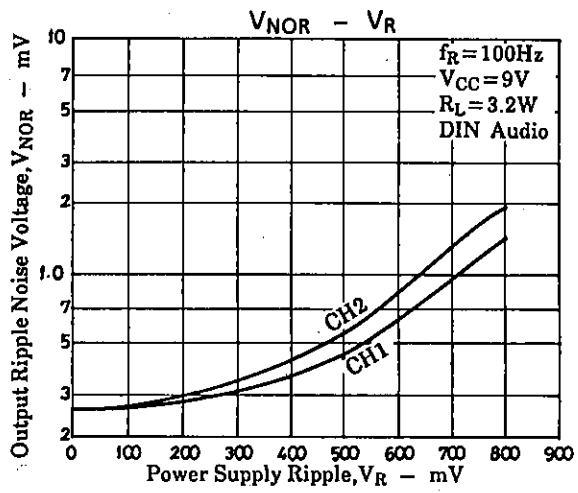
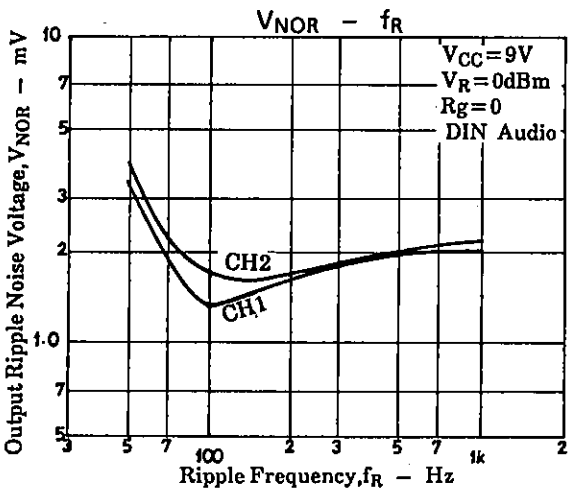
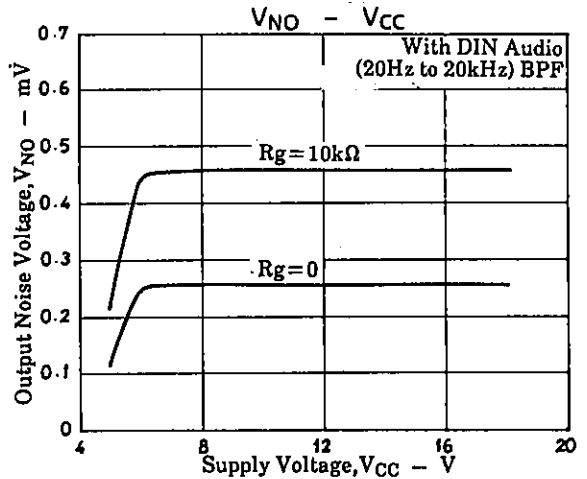
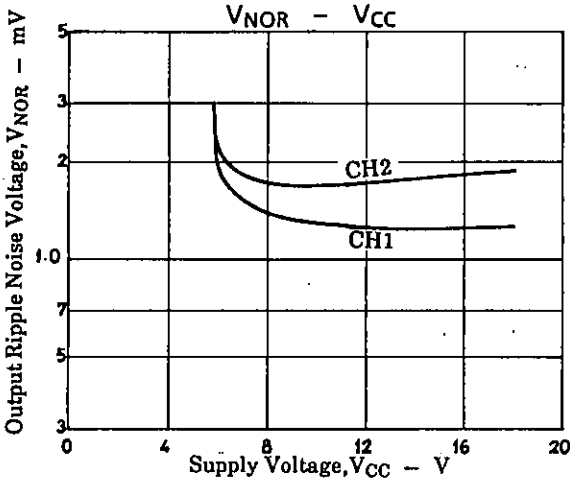
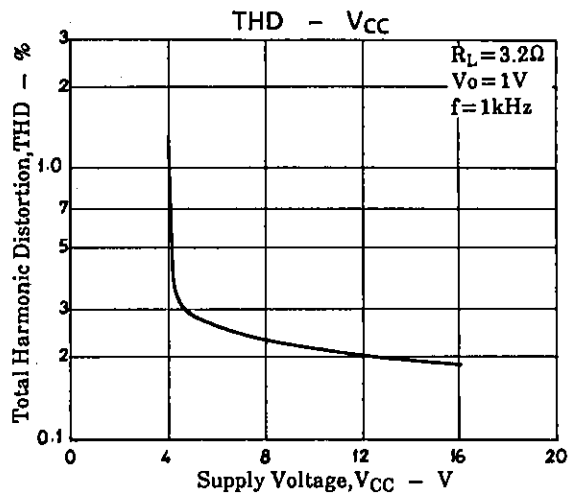
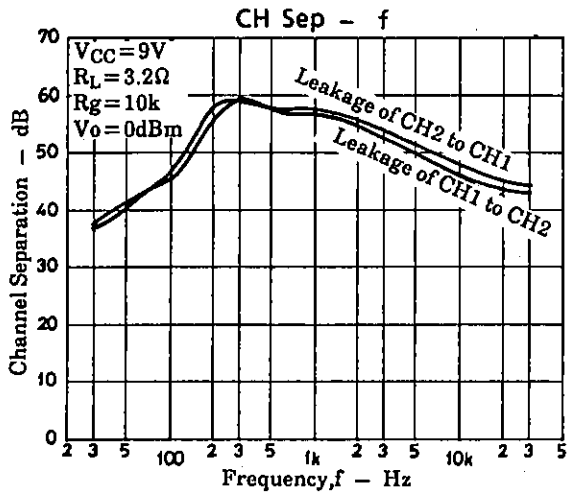
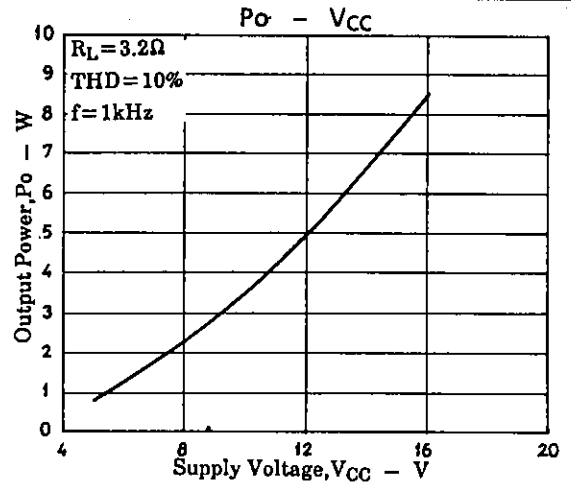
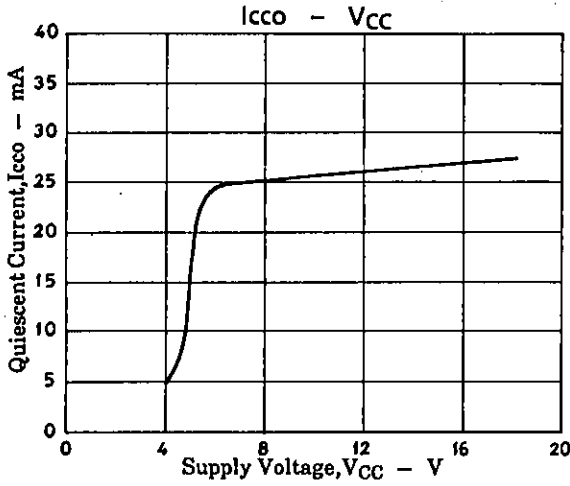

Sample BTL

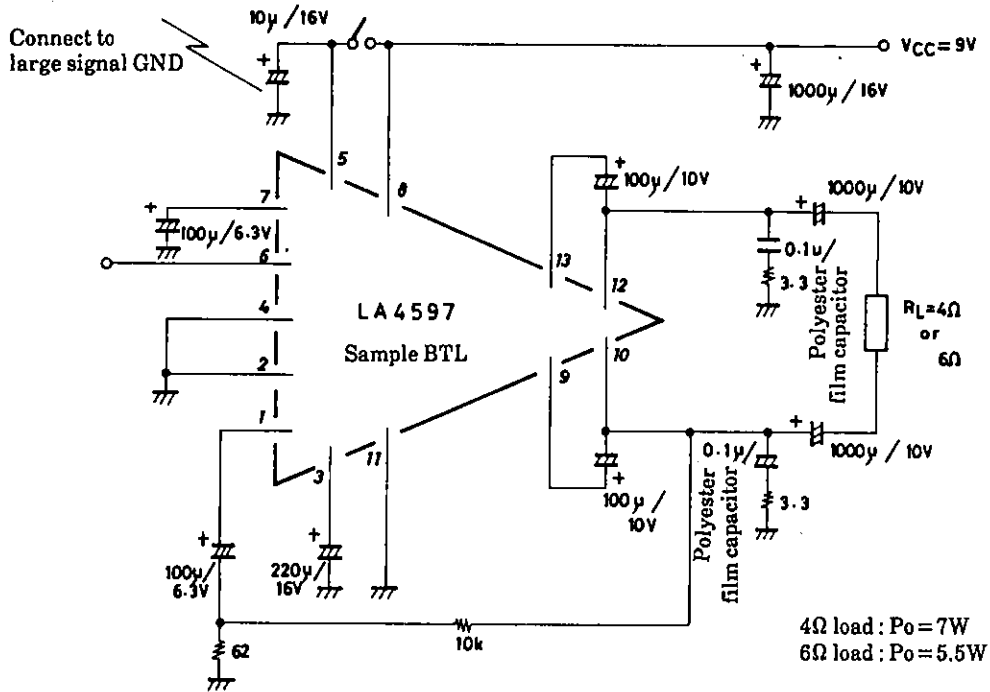

Unit (capacitance: F)

- No products described or contained herein are intended for use in surgical implants, life-support systems, aerospace equipment, nuclear power control systems, vehicles, disaster/crime-prevention equipment and the like, the failure of which may directly or indirectly cause injury, death or property loss.
- Anyone purchasing any products described or contained herein for an above-mentioned use shall:
 - ① Accept full responsibility and indemnify and defend SANYO ELECTRIC CO., LTD., its affiliates, subsidiaries and distributors and all their officers and employees, jointly and severally, against any and all claims and litigation and all damages, cost and expenses associated with such use;
 - ② Not impose any responsibility for any fault or negligence which may be cited in any such claim or litigation on SANYO ELECTRIC CO., LTD., its affiliates, subsidiaries and distributors or any of their officers and employees jointly or severally.
- Information (including circuit diagrams and circuit parameters) herein is for example only; it is not guaranteed for volume production. SANYO believes information herein is accurate and reliable, but no guarantees are made or implied regarding its use or any infringements of intellectual property rights or other rights of third parties.