

Ordering number : EN5504

Monolithic Linear IC



LA4905

17-W, 2-Channel BTL AF High-Efficiency Power Amplifier for Car Stereo Systems

Overview

The LA4905 is a BTL 2-channel power amplifier IC for use in car audio systems. Increases in the number of external components are held to a minimum by adopting both a signal-following type switching scheme in the amplifier's output stage power supply, and a newly-developed nonlinear amplifier that has nonlinear characteristics in the signal system. The power dissipation (thermal loss) in the actual operating range has been reduced to about 1/2 that of earlier class B amplifier ICs. This contributes significantly to miniaturization of the heat sink and to reduction of heating within the set.

Features

- Power dissipation reduced by 50% (When average music power is measured, and when compared to earlier Sanyo products.)
- The number of required signal follower circuits has been reduced to a single circuit for two channels, allowing the number of external components to be reduced.
- The output is a pure analog signal: no switching noise is output to the output lines.
- Operates on an 8 to 18-V single-voltage power supply.
- Full complement of built-in protection circuits (shorting to the power supply, shorting to ground, overvoltage, and thermal protection)
- Built-in standby switch

Package Dimensions

unit: mm

3160-SIP23HZ

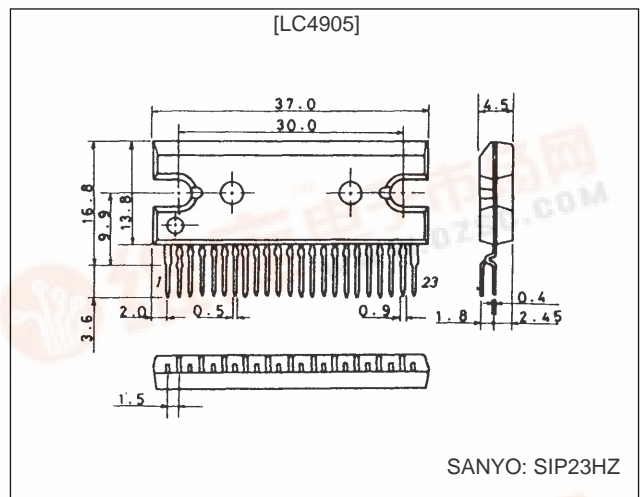

Specifications

Maximum Ratings at Ta = 25°C

Parameter	Symbol	Conditions	Ratings	Unit
Maximum supply voltage	V _{CC} max1	No input, t = 1 minute	24	V
	V _{CC} max2		18	V
Maximum output current	I _O Peak	(Per channel)	4.5	A
Allowable power dissipation	P _d max	With an arbitrarily large heat sink	37.5	W
Operating temperature	T _{opr}		-35 to +85	°C
Storage temperature	T _{stg}		-40 to +150	°C

Notes: 1. Set V_{CC} and R_L in the range where P_d max does not exceed 37.5 W.
2. The overvoltage protection circuit operates when V_{CC} is 20 V or higher.



LA4905

Operating Conditions at $T_a = 25^\circ\text{C}$

Parameter	Symbol	Conditions	Ratings	Unit
Recommended supply voltage	V_{CC}		13.2	V
Allowable operating supply voltage range	$V_{CC\text{ op}}$		8 to 18	V
Recommended load resistance	R_L		4	Ω
Recommended load resistance range	$R_L\text{ op}$		2 to 4	Ω

Notes: Set V_{CC} and R_L in the range where $P_d\text{ max}$ does not exceed 37.5 W.

Operating Characteristics at $T_a = 25^\circ\text{C}$, $V_{CC} = 13.2\text{ V}$, $R_L = 4\ \Omega$, $f = 1\text{ kHz}$, $R_g = 600\ \Omega$, in the recommended circuit

Parameter	Symbol	Conditions	min	typ	max	Unit
Quiescent current	I_{CCO}	$R_L = \infty$, $V_{IN} = 0$	80	110	150	mA
Standby current	I_{ST}			0	10	μA
Voltage gain	VG	$V_O = 0\text{ dBm}$	38	40	42	dB
Total harmonic distortion	THD	$P_O = 1\text{ W}$, LPF = 30 kHz		0.07	0.2	%
Output power 1	P_{O1}	THD = 10%, $R_L = 4\ \Omega$	14	17		W
	P_{O2}	THD = 10%, $R_L = 2\ \Omega$		25		W
Output noise voltage	V_{NO}	$R_g = 0$, BPF = 20 Hz to 20 kHz		0.15	0.3	mVrms
Ripple rejection ratio	SVRR	$R_g = 0$, $V_{CCR} = 0\text{ dBm}$, BPF = 20 Hz to 20 kHz	60	70		dB
Channel separation	CHsep	$R_g = 10\text{ k}\Omega$, $V_O = 0\text{ dBm}$, BPF = 20 Hz to 20 kHz	45	55		dB
Input resistance	R_i		21	30		$\text{k}\Omega$
Output offset voltage	$V_N\text{ offset}$	$R_g = 0$	-300		+300	mV
Standby on voltage	V_{STH}	AMP = on, applied through a 10 $\text{k}\Omega$ resistor	3		V_{CC}	V

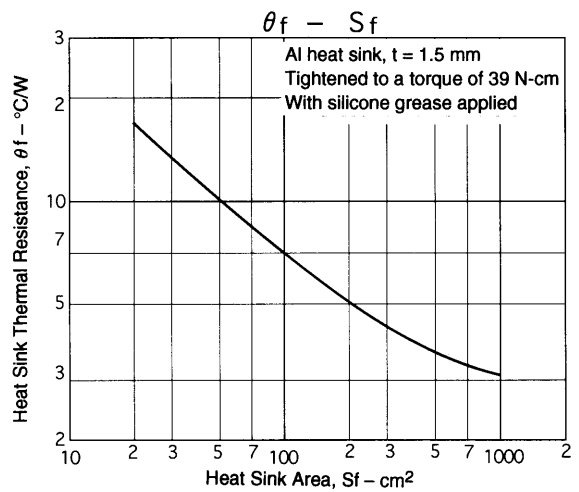
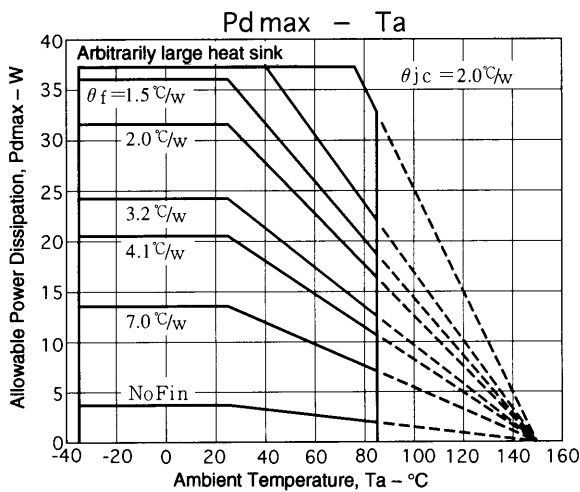

LA4905 High-Efficiency Technology

(1) Signal-following switching scheme

The LA4905 adopts a switching regulator scheme in the power supply applied to the amplifier output stage. The LA4905 power dissipation is reduced significantly by having the output voltage of the switching regulator follow the input signal. Furthermore, in combination with the nonlinear amplifier scheme described below, the LA4905 design reduces the number of switching regulators to merely one circuit even though it is a BTL 2-channel amplifier. (See Figure 1.)

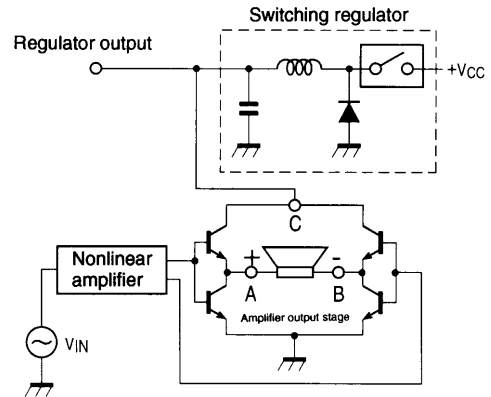

Figure 1 Overview Block Diagram

(2) Nonlinear amplifier

The LA4905 adopts a nonlinear amplifier that has the nonlinear characteristics shown in Figure 2 in the amplifier signal system. This scheme does not use the center point voltage of 1/2 VCC used in normal amplifiers, but instead uses a voltage about 2 V lower. This allows the design to dispense with the lower side switching regulator.

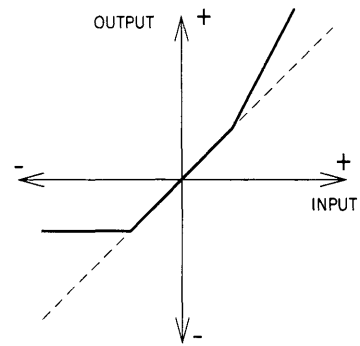

Figure 2 Nonlinear Amplifier Input/Output Characteristics

This nonlinear amplifier has a structure based on a differential amplifier that has symmetric negative feedback circuits. Although the BTL output stage positive and negative phase output waveform is a half-wave waveform that is expanded and compressed as shown in Figure 3, the combined output waveform at the negative load terminal is identical to that output by earlier products.

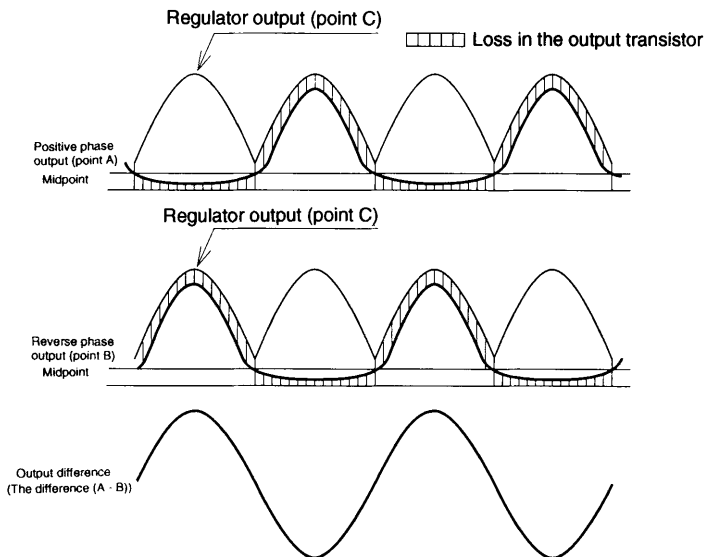

Figure 3 Output Waveforms

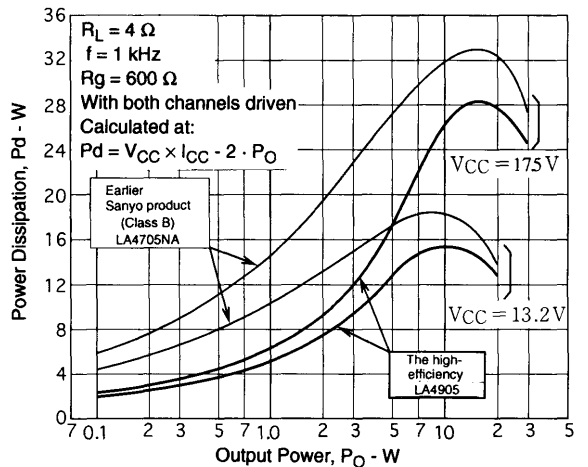
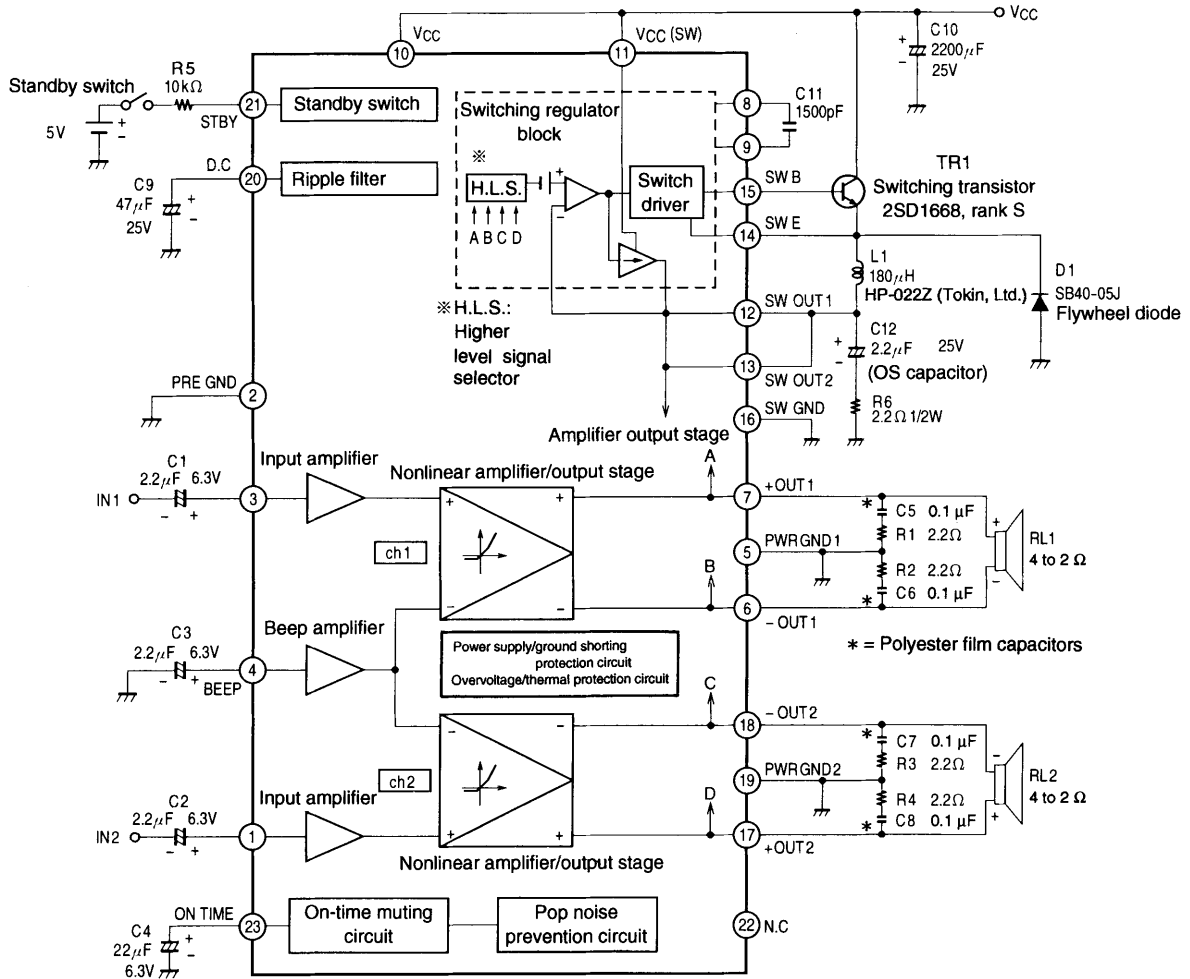

Figure 4 Power Dissipation Comparison with Earlier Products

LA4905

Equivalent Circuit Block Diagram



T000019

Pin Voltages $V_{CC} = 13.2\text{ V}$, 5 V applied to STBY through a $10\text{-k}\Omega$ resistor, using a digital voltmeter

Pin No.	1	2	3	4	5	6	7	8
Pin	IN2	Pre-GND	IN1	BEEP	PWR-GND 1	-OUT1	+OUT1	C
Pin voltage (V)	1.36	0	1.36	1.36	0	2.03	2.03	13.0

Pin No.	9	10	11	12	13	14	15	16
Pin	C	V_{CC}	$V_{CC}(\text{SW})$	SW OUT 1	SW OUT 2	SW E	SW B	SW-GND
Pin voltage (V)	3.92	13.2	13.2	3.70	3.70	3.73	4.0	0

Pin No.	17	18	19	20	21	22	23	
Pin	+OUT 2	-OUT 2	PWR-GND 2	D. C	STAND-BY	N. C	ON-TIME	
Pin voltage (V)	2.03	2.03	0	12.1	3.21	0	2.81	

LA4905

Sample Printed Circuit Board Pattern

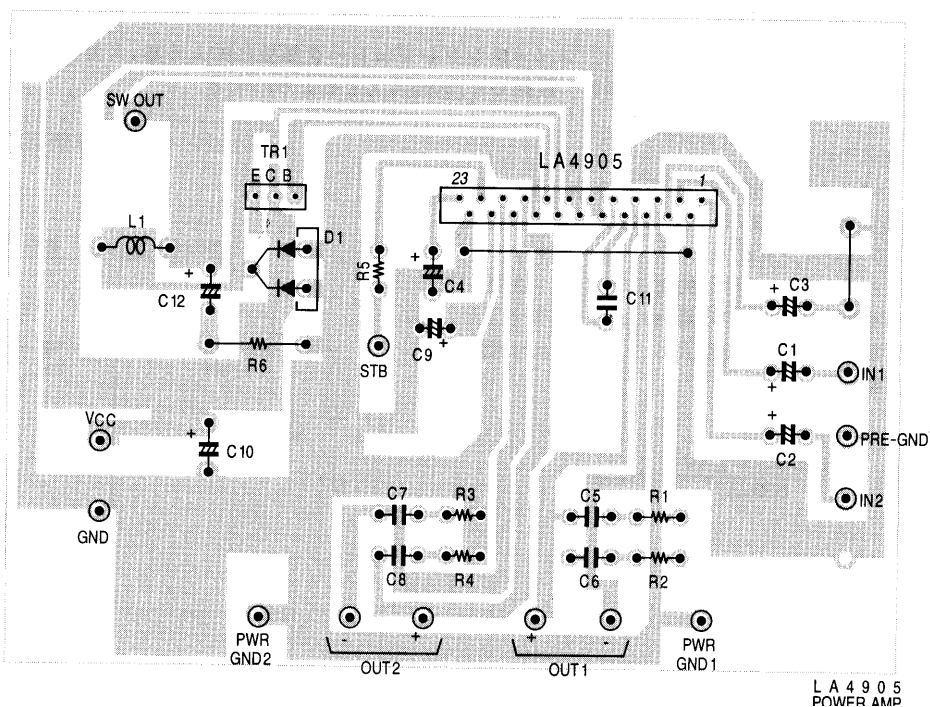

LA4905
POWER AMP

T00021

1. External Component Functions

- C1, C2 • Input capacitors; recommended value: 2.2 μF . Note that the low-frequency band can be adjusted by changing the values of C1 and C2, since f_L depends on their value, although the value must not exceed 3.3 μF (when C4 is 22 μF) due to pop noise considerations.
- C3 • Beep amplifier input capacitor. Use the same value as that used for C1 and C2. Connect the beep amplifier to PRE-GND through C3 if the beep function is not used.
- C4 • Amplifier power-on delay time setting capacitor; recommended value: 22 μF . At the recommended value, the amplifier will turn on in about 0.7 second after power is applied. The delay time is proportional to the capacitance and can be set to an arbitrary value. However, a value of 22 μF or larger should be used due to pop noise considerations.
- C5, C6, C7, C8 • Oscillation prevention capacitors. Use capacitors with excellent temperature characteristics such as polyester film or Mylar capacitors. These capacitors function in conjunction with R1, R2, R3, and R4. We recommend using capacitors of 0.1 μF or larger, since the stability varies somewhat depending on the printed circuit board layout.
- C9 • Decoupling capacitor (ripple filter)
- C10 • Power-supply capacitor
- C11 • Switching regulator oscillation prevention capacitor; recommended value: 1500 pF.
- C12 • Switching regulator output smoothing capacitor. The LA4905 adopts a self-excitation switching regulator scheme. Since this capacitor influences the stability of the self-excitation and the regulator efficiency, there is an optimal value. We recommend the use of a 2.2- μF , 25-V OS capacitor with good temperature characteristics. Note that a 2.2- Ω , 1/2-W resistor should be used for R5 for the same reason.
- R5 • Standby switch current limiting resistor; recommended value: 10 k Ω .
(When the voltage applied to the standby switch is between 3 and 13.2 V.) Note that this resistor cannot be removed. See the section "Standby Function" elsewhere in this document.
- TR1 • External switching transistor. We recommend using a 2SD1668 of rank S. A 2SD1667 of rank S may be used if the application is designed to handle 4- Ω loads (R_L). A heat sink must be provided along with that for the IC.
- D1 • Flywheel diode that takes up the coil energy. We recommend using an SB40-05J, which is a Schottky barrier diode with a low V_F .
An SB10-05A2 may be used if the application is designed to handle 4- Ω loads (R_L). A joint heat sink is not required.
- L1 • We recommend the use of the HP-022Z 180- μH coil manufactured by Tokin, Ltd. The 200- μH HP-011Z may be used if the application is designed to handle 4- Ω loads (R_L).

2. IC Internal Characteristics and Usage Notes

Switching Regulator

- To reduce power dissipation, the LA4905 includes a signal-following type switching regulator. When there is no input signal, the self-excited oscillator operates at about 100 kHz.
- It is desirable for the amplifier block to be separated as far as possible from the tuner block to prevent interference from extraneous radiation within the set. Also, when designing the printed circuit board layout, the pattern lines for the switching regulator components should be made as short and as broad as possible.
- To prevent degradation of the characteristics of the LA4905 itself, the separation between the switching regulator components and the IC input block (the input block pattern, the input capacitors, and the beep capacitor) should be at least 1.5 cm.

Standby Function

- Pin 21 is the standby switch pin. The amplifier is turned on by applying a voltage of about 3 V or higher through an external resistor (R1).
- The value of R1 must be determined, using the following formula, so that the pin 5 influx current remains under 500 μ A if a voltage in excess of 13.2 volts is applied as the standby switch voltage.

$$R1 = \frac{\text{applied voltage} - 1.4 \text{ V}}{500 \mu\text{A}} - 10 \text{ k}\Omega$$

BEEP Pin (pin 4)

- If the BEEP pin is used, use a value for R102 shown in the figure that is under 100 Ω and is as small as possible to prevent degradation of the IC output noise voltage (VNO).

Protection Circuits

- The LA4905 includes a built-in thermal protection circuit to prevent destruction or degradation if the IC generates abnormal amounts of heat. The thermal protection circuit controls the IC so that the output is gradually lowered if the IC junction temperature (T_j) increases to about 160°C due to an insufficient heat sink or other reason.
- The overvoltage protection circuit operates if the V_{CC} voltage exceeds a value of about 20 volts.
- Although the LA4905 includes an on-chip protection circuit for shorts to V_{CC} and shorts to ground, it does not include a load shorted protection circuit. The idea behind this design is that the thermal protection circuit will protect the IC against load shorting. However, since load shorting can also cause heating in external transistors and coils, designs should take load shorting into consideration.

Other Notes

- Pin 22 is an NC pin, and is not connected within the package.

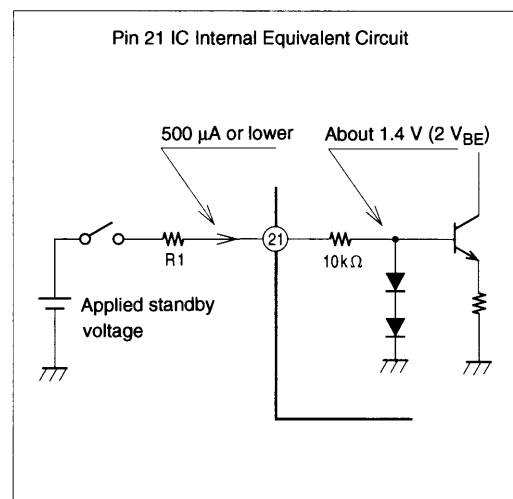

T00022

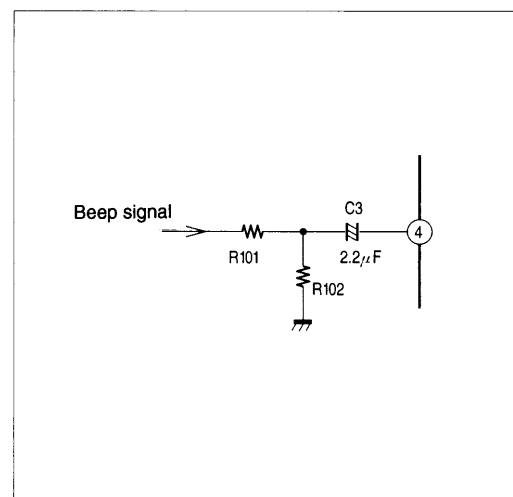

T00023

LA4905

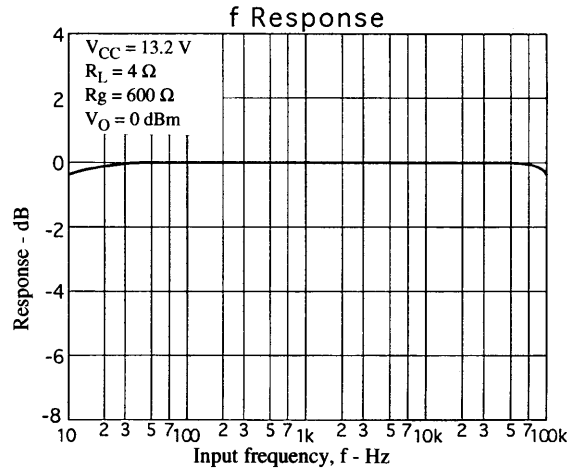
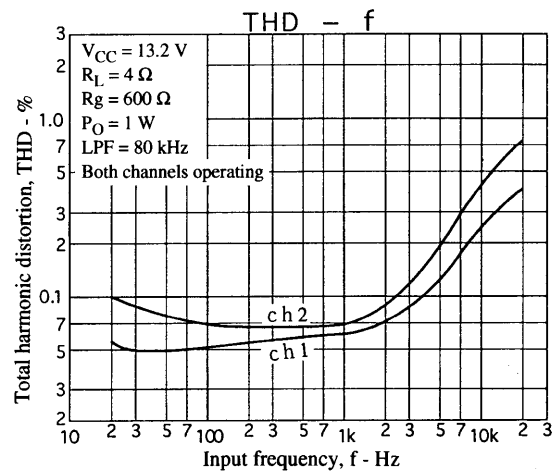
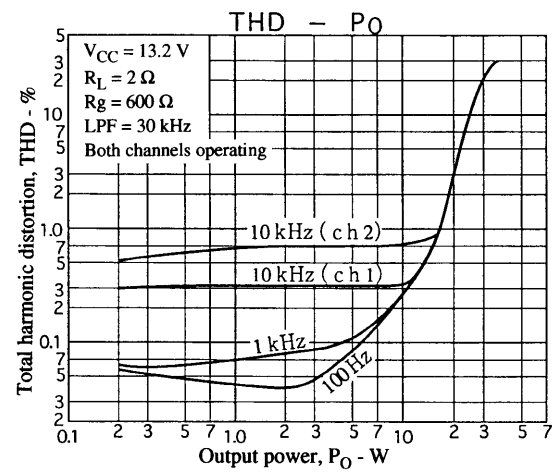
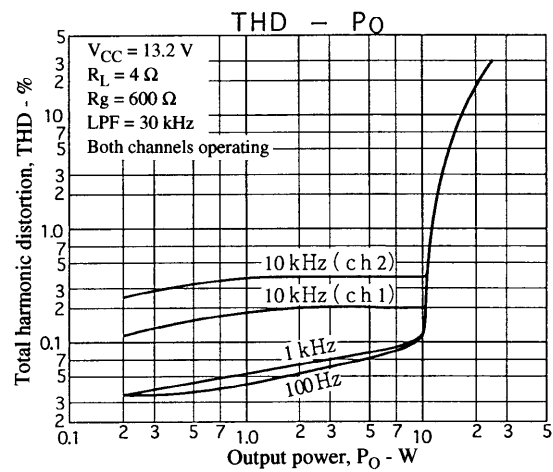
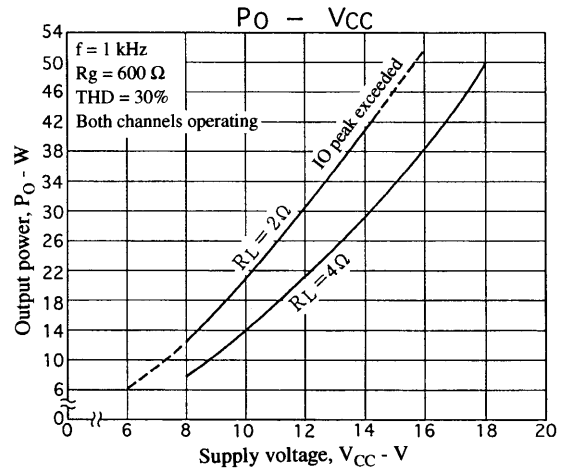
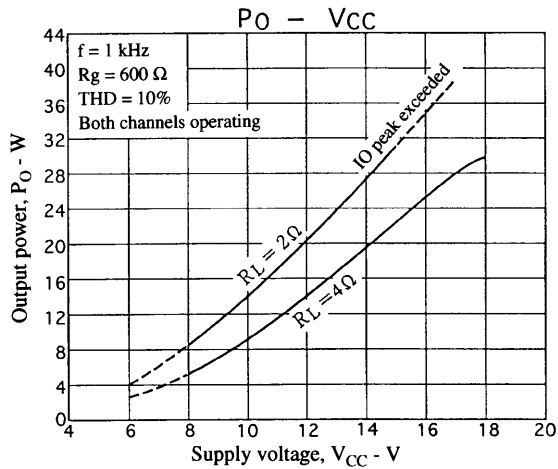
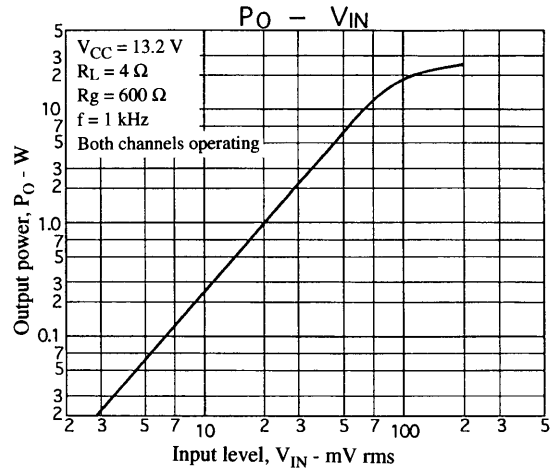
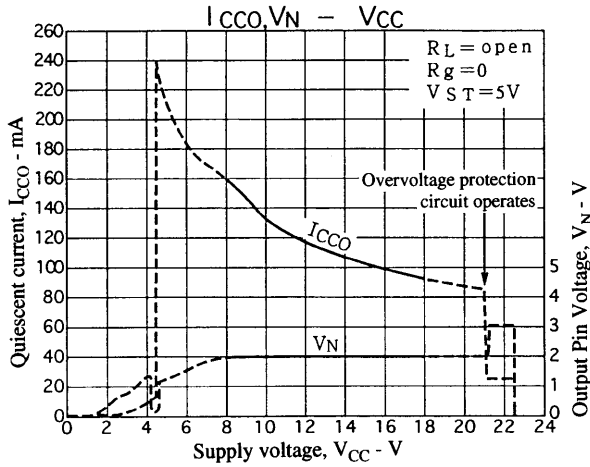

LA4905

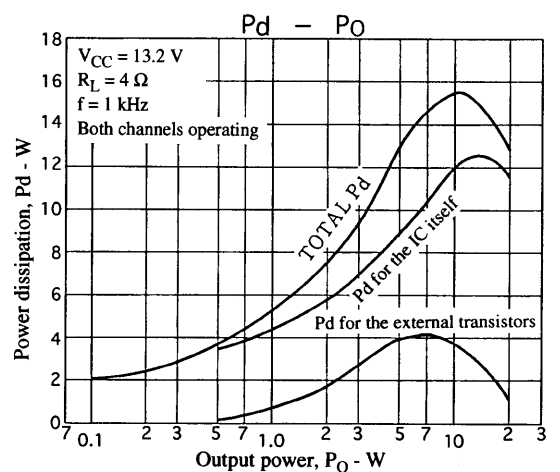
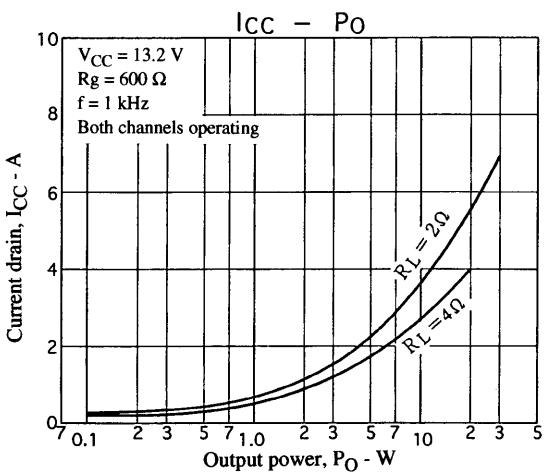
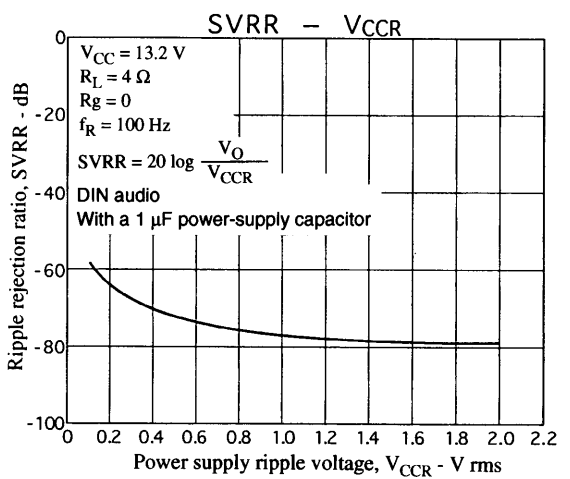
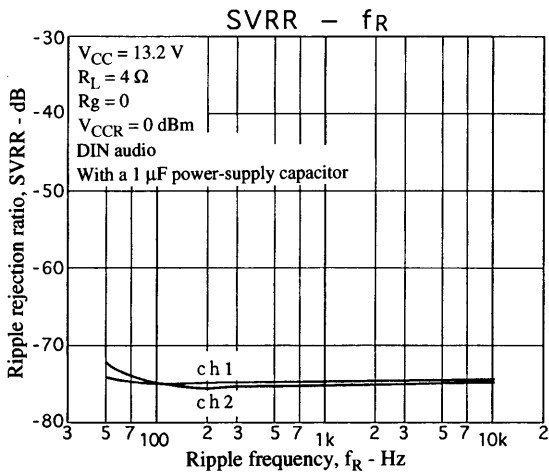
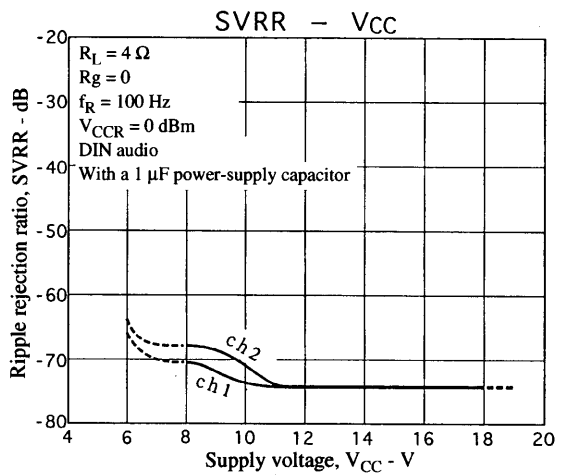
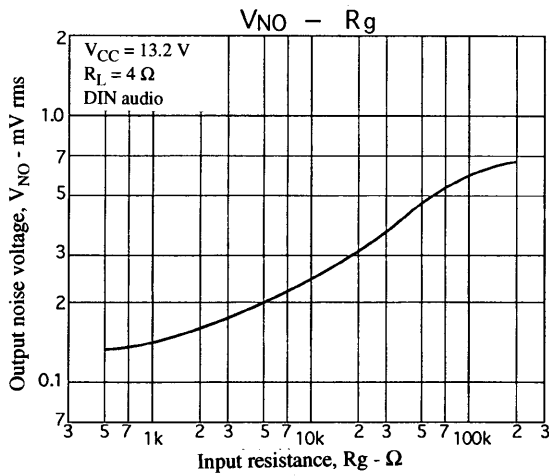
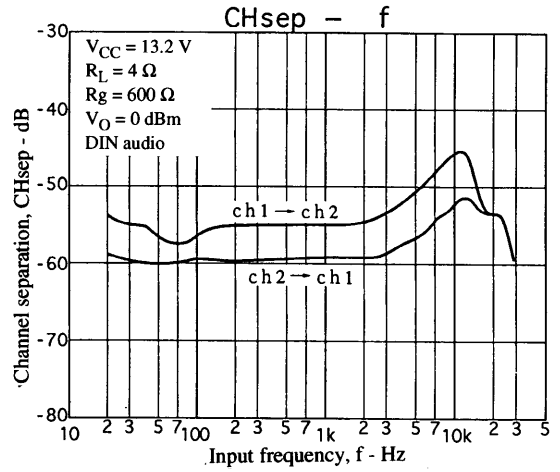
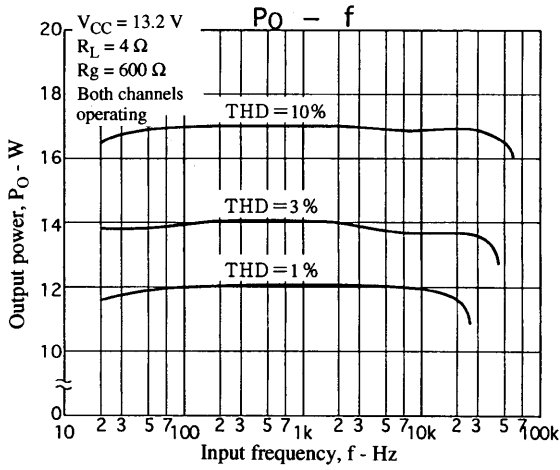

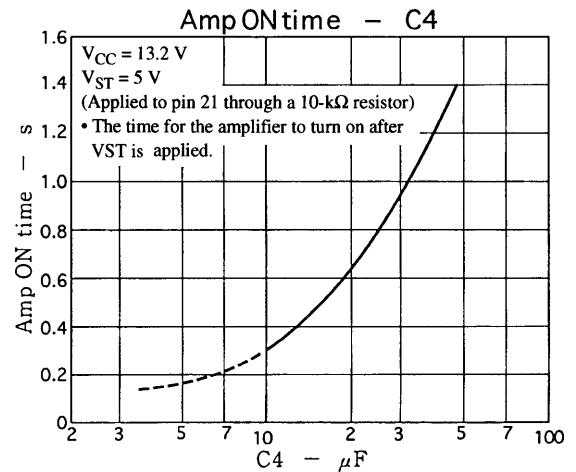
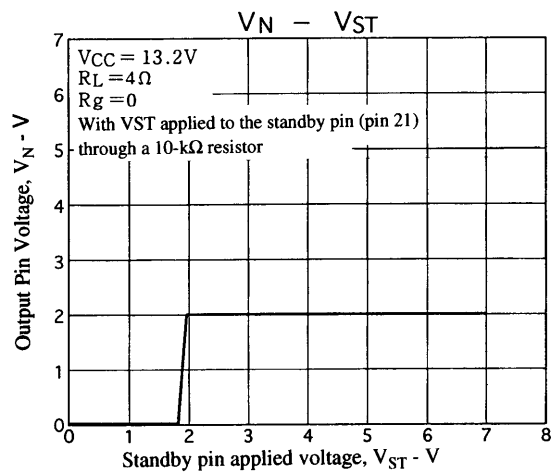
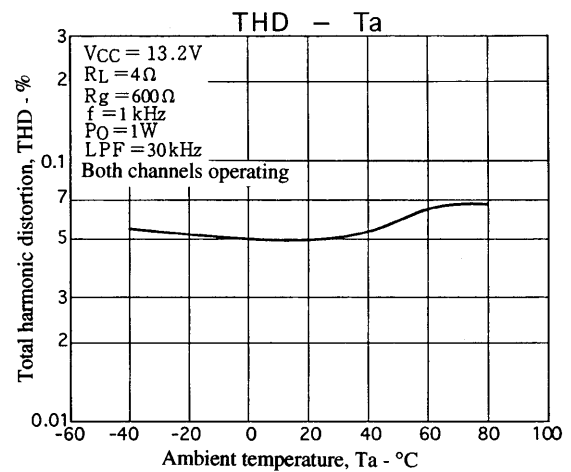
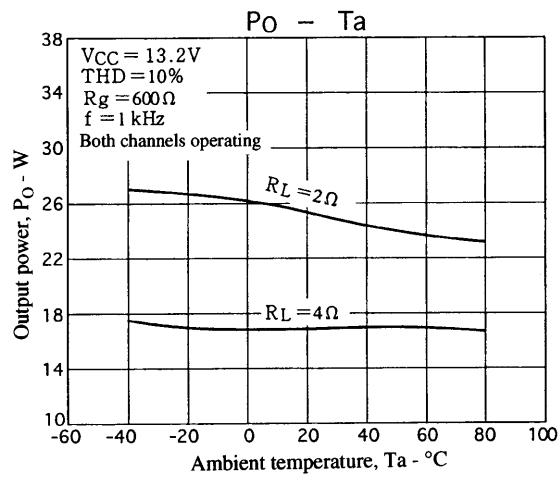
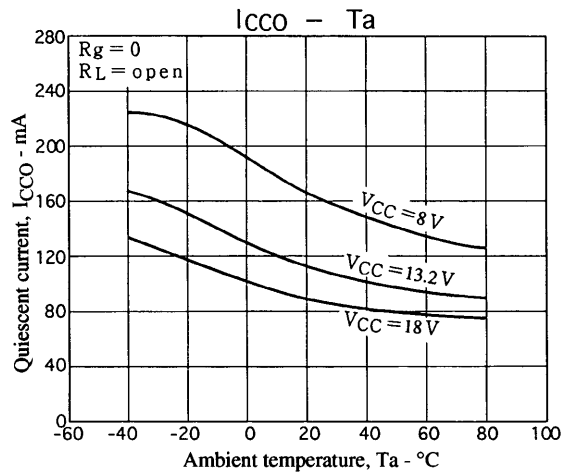
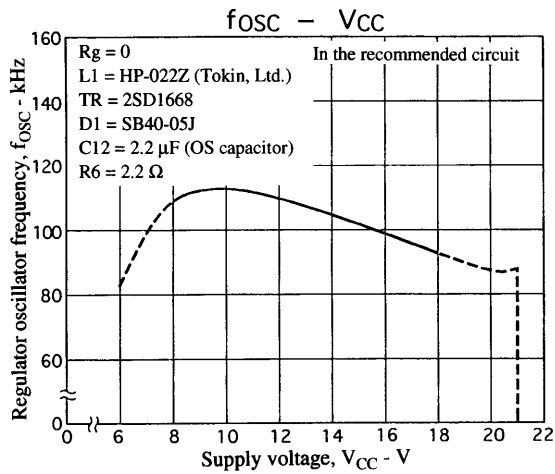
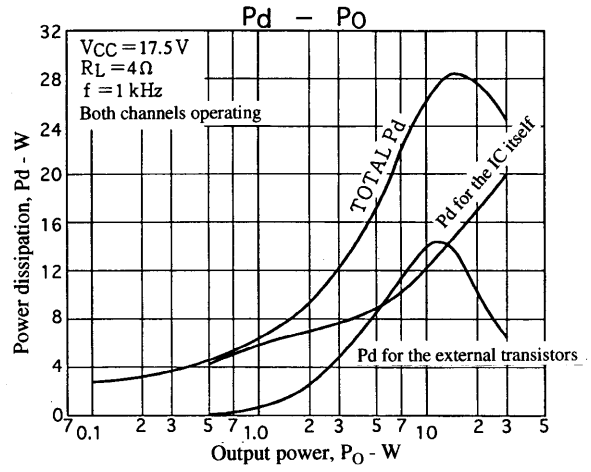
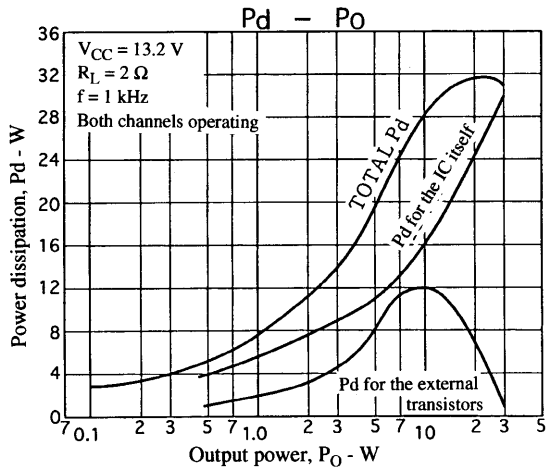

- No products described or contained herein are intended for use in surgical implants, life-support systems, aerospace equipment, nuclear power control systems, vehicles, disaster/crime-prevention equipment and the like, the failure of which may directly or indirectly cause injury, death or property loss.
- Anyone purchasing any products described or contained herein for an above-mentioned use shall:
 - ① Accept full responsibility and indemnify and defend SANYO ELECTRIC CO., LTD., its affiliates, subsidiaries and distributors and all their officers and employees, jointly and severally, against any and all claims and litigation and all damages, cost and expenses associated with such use:
 - ② Not impose any responsibility for any fault or negligence which may be cited in any such claim or litigation on SANYO ELECTRIC CO., LTD., its affiliates, subsidiaries and distributors or any of their officers and employees jointly or severally.
- Information (including circuit diagrams and circuit parameters) herein is for example only; it is not guaranteed for volume production. SANYO believes information herein is accurate and reliable, but no guarantees are made or implied regarding its use or any infringements of intellectual property rights or other rights of third parties.