



**Low-voltage/Low-saturation Bidirectional Constant-Voltage Regulated Motor Driver**

**Overview**

The LB1839M is a low-voltage, low-saturation, three-input type two-channel bidirectional motor driver that permits switching between constant-voltage regulated output and saturated output. The design of the LB1839M is ideal for a two-phase bipolar driver for stepping motors.

**Features**

- Wide operating voltage range (3.0 to 9.0 V).
- Low saturation voltage  
 $V_O$  (sat) = 0.40 V at  $I_O = 200$  mA.
- Consumes almost no current in standby mode (0.1  $\mu$ A or less).
- Permits setting of bidirectional constant-voltage regulated value.
- Three-input type that is ideal for a two-phase bipolar driver.
- Permits switching between constant-voltage regulated output and saturated output.
- Built-in reference voltage coupled to input.
- Compact MFP14S package.

**Package Dimensions**

unit: mm

**3111-MFP14S**

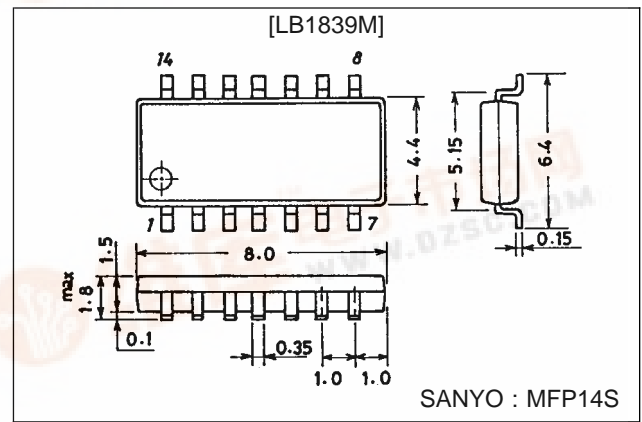

**Specifications**

**Absolute Maximum Ratings at  $T_a = 25$  °C**

Parameter	Symbol	Conditions	Ratings	Unit
Maximum supply voltage	$V_{CC}$ max		10.5	V
Output current	$I_m$ max		250	mA
Applied input voltage	$V_{IN}$		-0.3 to +10	V
Allowable power dissipation	$P_d$ max	With board ( 30 x 30 x 1.5 mm <sup>3</sup> )	800	mW
Operating temperature	$T_{opr}$		-20 to +80	°C
Storage temperature	$T_{stg}$		-40 to +125	°C

**Allowable Operating Ranges at  $T_a = 25$  °C**

Parameter	Symbol	Conditions	Ratings	Unit
Supply voltage	$V_{CC}$		3.0 to 9.0	V
Input [H] voltage	$V_{IH}$		3.0 to 9.0	V
Input [L] voltage	$V_{IL}$		-0.3 to +0.7	V
Control voltage	$V_C$		0.2 to 6.0	V



## LB1839M

### Electrical Characteristics at $T_a = 25\text{ }^\circ\text{C}$ , $V_{CC} = 6\text{ V}$

Parameter	Symbol	Conditions	min	typ	max	Unit
Supply current	$I_{CC0}$	During standby		0.1	10	$\mu\text{A}$
	$I_{CC1}$	(For two channel) During bidirectional operation, during control, load open		3.5	5.0	$\text{mA}$
	$I_{CC2}$	(For two channel) During bidirectional operation, during saturation, load open		4.0	6.0	$\text{mA}$
Output saturation voltage	$V_{sat1}$	$I_O = 100\text{ mA}$ (upper side + lower side)		0.30	0.40	V
	$V_{sat2}$	$I_O = 200\text{ mA}$ (upper side + lower side)		0.40	0.55	V
	$V_{sat3}$	$I_O = 200\text{ mA}$ (lower side)	0.07	0.10	0.15	V
Reference voltage	$V_{ref}$	$I_{vref} = 1\text{ mA}$	1.85	2.0	2.15	V
Output voltage voltage characteristics	$\frac{\Delta V_O}{\Delta V_{CC}}$	$V_O = 5\text{ V}$ , $V_{CC} = 5.5\text{ to }9\text{ V}$ , $I_O = 100\text{ mA}$			20	$\text{mV}$
Output voltage current characteristics	$\frac{\Delta V_O}{\Delta I_{CC}}$	$V_O = 5\text{ V}$ , $V_{CC} = 6\text{ V}$ , $I_O = 10\text{ to }100\text{ mA}$			50	$\text{mV}$
Input current	$I_{IN}$	$V_{IN} = 5\text{ V}$		90	150	$\mu\text{A}$
Output voltage	$V_O$	Between OUT and GND	$2.5 \times V_C$		$2.7 \times V_C$	V

### Equivalent Circuit Block Diagram

(For one channel)

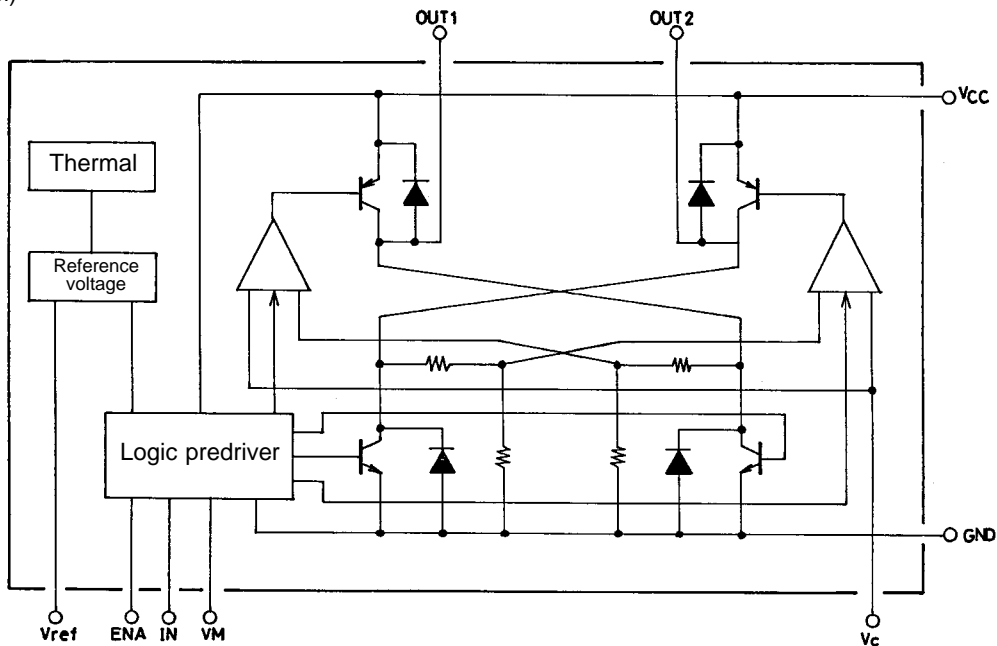

### Truth Table

Input			Output		Mode
ENA	IN 1/2	VM 1/2	OUT 1/3	OUT 2/4	
L	—	—	OFF	OFF	Standby
H	L	L	H	L	Constant-voltage regulated forward operation
H	L	H	H	L	Saturated forward operation
H	H	L	L	H	Constant-voltage regulated reverse operation
H	H	H	L	H	Saturated reverse operation

### Pin Assignment

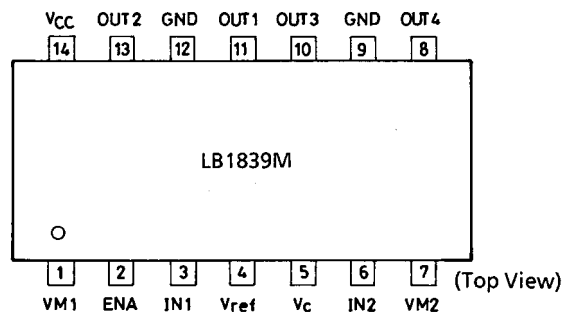

Note: Both GND pins must be grounded.

The constant-voltage regulated output  $V_O$  (= voltage between H side output and GND) is controlled by  $2.5 \times V_C$ . The output is in the saturated state when the  $V_C$  input range is  $0.2\text{ to }6\text{ V}$  and  $V_O \cong V_{CC}$ .

# LB1839M

## Pin Functions

Pin No.	Symbol	Equivalent Circuit Diagram	Pin Function
14	V <sub>CC</sub>		Power supply pin for output and controller.
9 12	GND		GND pins for output and controller. Both must be grounded.
3 6	IN2 IN1		<p>Input pins that determine the excitation of the outputs.            IN1 control outputs OUT1 and OUT2; IN2 control outputs OUT3 and OUT4.            L: -0.3 to +0.7 V            H: 3.0 to 9.0 V            There are no limitations on the magnitude relationships between the V<sub>CC</sub> and V<sub>IN</sub> supply voltages.</p>
8 10 11 13	OUT4 OUT3 OUT1 OUT2		<p>Output pins.            Have built-in spark killer diodes.</p>
4	V <sub>ref</sub>		<p>Reference voltage (= 2.0 V).</p>
5	V <sub>C</sub>		<p>Input pins that determine the constant-voltage regulated output level.            The constant-voltage regulated output V<sub>O</sub> (= voltage between H side output and GND) is controlled by V<sub>O</sub> = 2.5 x V<sub>C</sub>. There are no limitations on the magnitude relationships between the V<sub>CC</sub> and V<sub>C</sub> supply voltages.</p>
2	ENA		<p>Standby/drive control input pin            Current consumption in standby mode is 10 μA or less.            L: -0.3 to + 0.7 V            H: 3.0 to 9.0 V</p>
1 7	VM1 VM2		<p>Output voltage setting            Control input pin for switching between constant voltage output and saturated output. There are no limitations on the magnitude relationships between the V<sub>CC</sub>, V<sub>M1</sub> and V<sub>M2</sub> supply voltages.            L: -0.3 to + 0.7 V            (constant-voltage regulated output)            H: 3.0 to 9.0 V (saturated output)</p>

# LB1839M

## Sample Application Circuit

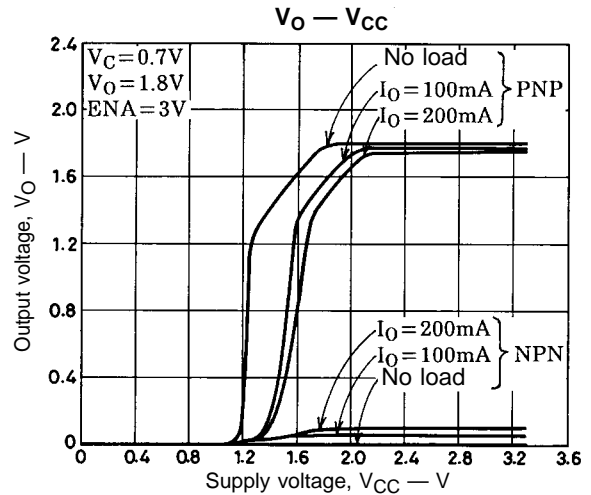
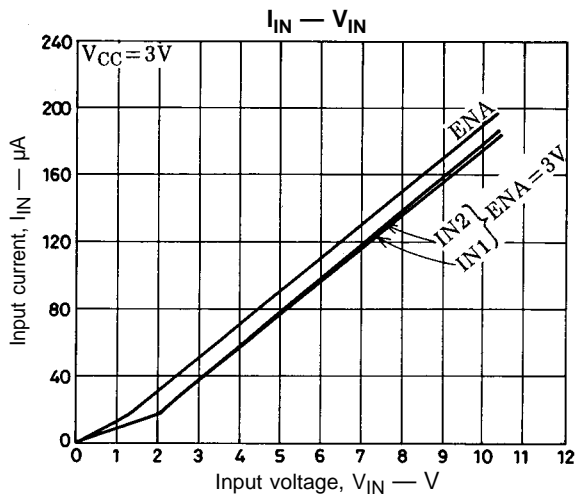
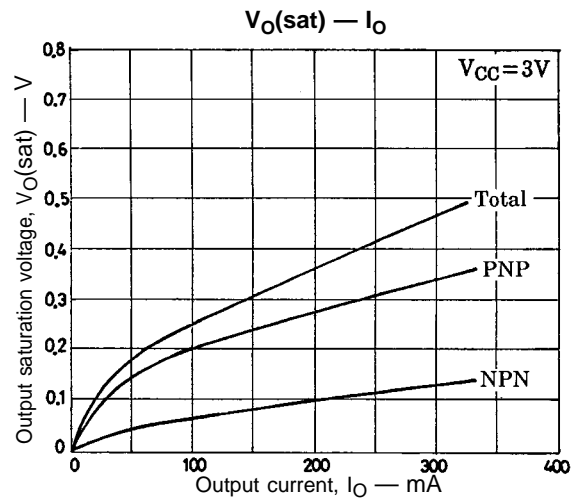
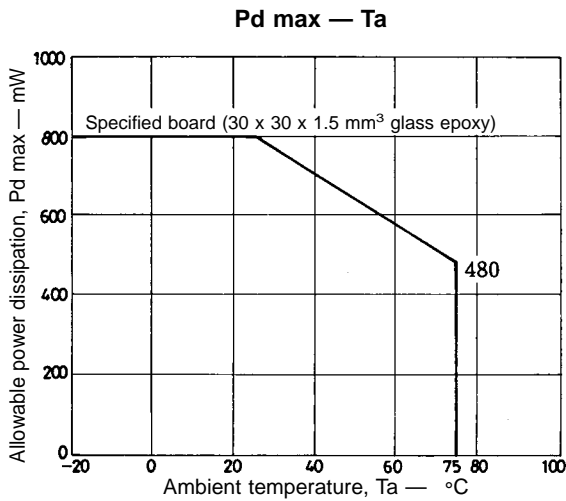
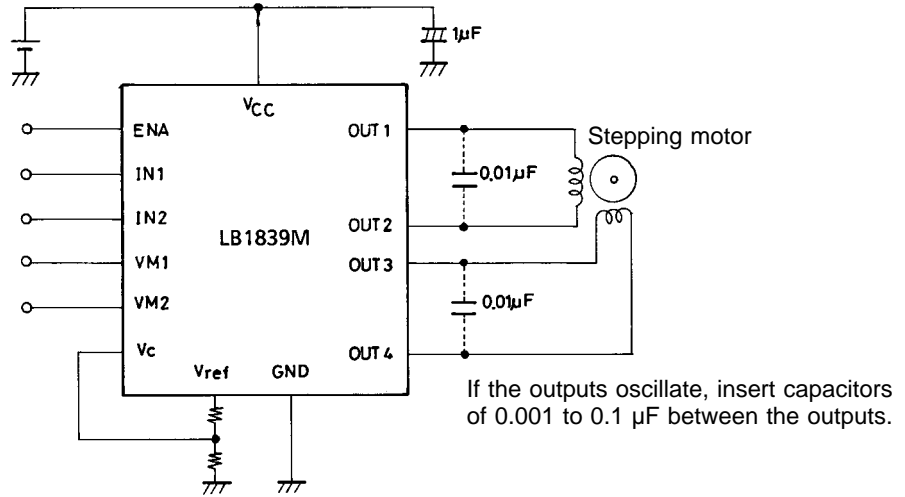

## LB1839M

---

- No products described or contained herein are intended for use in surgical implants, life-support systems, aerospace equipment, nuclear power control systems, vehicles, disaster/crime-prevention equipment and the like, the failure of which may directly or indirectly cause injury, death or property loss.
- Anyone purchasing any products described or contained herein for an above-mentioned use shall:
  - ① Accept full responsibility and indemnify and defend SANYO ELECTRIC CO., LTD., its affiliates, subsidiaries and distributors and all their officers and employees, jointly and severally, against any and all claims and litigation and all damages, cost and expenses associated with such use:
  - ② Not impose any responsibility for any fault or negligence which may be cited in any such claim or litigation on SANYO ELECTRIC CO., LTD., its affiliates, subsidiaries and distributors or any of their officers and employees jointly or severally.
- Information (including circuit diagrams and circuit parameters) herein is for example only; it is not guaranteed for volume production. SANYO believes information herein is accurate and reliable, but no guarantees are made or implied regarding its use or any infringements of intellectual property rights or other rights of third parties.