



LH1529FP/ FPTR/ GP/ GPTR

Vishay Semiconductors

Telecom Switch - 1 Form A Solid State Relay

Features

- Solid State Relay and Optocoupler in One Package
- Surface Mount Package - **NEW FLAT PAK**
- Isolation Test Voltage, 3000 V_{RMS}
- LH1529FP, CTR Min. = 33 %
- LH1529GP, CTR Min. = 100 %
- Optocoupler
 - Bidirectional Current Detection
- Solid-state Relay (Equivalent to TS117P)
 - Typical R_{ON} 20 Ω
 - Load Voltage 350 V
 - Load Current 120 mA
 - Current Limit Protection
 - High Surge Capability
 - Clean Bounce Free Switching
 - Low Power Consumption
 - High Reliability Monolithic Detector
- Lead-free component
- Component in accordance to RoHS 2002/95/EC and WEEE 2002/96/EC

Agency Approvals

- UL1577, File No. E52744 System Code H or J, Double Protection
- FIMKO Approval

Applications

PCMCIA/Notebook

General Telecom Switching

- On/off Hook Control
- Dial Pulse
- Ring Current Detection
- Loop Current Sensing

See "Solid State Relays" (Application Note 56)

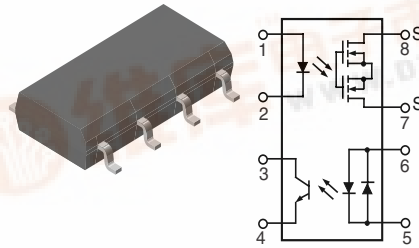

1179650



Description

The LH1529FP and LH1529GP Telecom switches consist of an optically coupled solid state relay (SSR) and a bidirectional input optocoupler. The SSR is ideal for performing switch hook and dial-pulse switching while the optocoupler performs ring detection and loop current sensing functions. Both the SSR and opto coupler provide 3000 V_{RMS} of input to output isolation.

The SSR is integrated on a monolithic receptor die using high voltage technology. The SSR features low ON resistance, high breakdown voltage and current-limit circuitry that protects the relay from telephone line induced lightning surges.

The optocoupler provides bidirectional current sensing via two anti parallel GaAs infrared emitting diodes. The opto channel provides a minimum CTR of 33 % at 6.0 mA.

The LH1529FP and LH1529GP come in an 8 pin, 0.080 inch thick plastic flat pak, SMD.

Order Information

Part	Remarks
LH1529FP	Tubes, SMD-8
LH1529FPTR	Tape and Reel, SMD-8
LH1529GP	Tubes, SMD-8
LH1529GPTR	Tape and Reel, SMD-8



LH1529FP/ FPTR/ GP/ GPTR



Vishay Semiconductors

Absolute Maximum Ratings, $T_{amb} = 25\text{ }^{\circ}\text{C}$

Stresses in excess of the absolute Maximum Ratings can cause permanent damage to the device. Functional operation of the device is not implied at these or any other conditions in excess of those given in the operational sections of this document. Exposure to absolute Maximum Ratings for extended periods of time can adversely affect reliability.

SSR

Parameter	Test condition	Symbol	Value	Unit
LED continuous forward current		I_F	50	mA
LED reverse voltage	$I_R \leq 10\text{ }\mu\text{A}$	V_R	6.0	V
DC or peak AC load voltage	$I_L \leq 50\text{ }\mu\text{A}$	V_L	350	V
Continuous DC load current		I_L	120	mA
Ambient temperature range		T_{amb}	- 40 to + 85	$^{\circ}\text{C}$
Storage temperature range		T_{stg}	- 40 to + 125	$^{\circ}\text{C}$
Soldering temperature	$t = 10\text{ s max.}$		260	$^{\circ}\text{C}$
Isolation test voltage (for 1.0 s)		V_{ISO}	3000	V_{RMS}
Isolation resistance	$V_{IO} = 500\text{ V, } T_{amb} = 25\text{ }^{\circ}\text{C}$	R_{IO}	$\geq 10^{12}$	Ω
	$V_{IO} = 500\text{ V, } T_{amb} = 100\text{ }^{\circ}\text{C}$	R_{IO}	$\geq 10^{11}$	Ω
Power dissipation		P_{diss}	600	mW

Optocoupler

Parameter	Test condition	Symbol	Value	Unit
LED continuous forward current		I_F	50	mA
LED reverse voltage	$I_R \leq 10\text{ }\mu\text{A}$	V_R	6.0	V
Collector-emitter breakdown voltage		BV_{CEO}	30	V
Phototransistor power dissipation		P_{diss}	150	mW

Electrical Characteristics, $T_{amb} = 25\text{ }^{\circ}\text{C}$

Minimum and maximum values are testing requirements. Typical values are characteristics of the device and are the result of engineering evaluations. Typical values are for information only and are not part of the testing requirements.

SSR

Parameter	Test condition	Symbol	Min	Typ.	Max	Unit
LED forward current for switch turn-on	$I_L = 100\text{ mA, } t = 10\text{ ms}$	I_{Fon}		1.1	3.0	mA
LED forward current for switch turn-off	$V_L = \pm 300\text{ V}$	I_{Foff}	0.2	1.0		mA
LED forward voltage	$I_F = 10\text{ mA}$	V_F	1.0	1.2	1.5	V
ON-Resistance	$I_F = 5.0\text{ mA, } I_L = \pm 50\text{ mA}$	R_{ON}		20	25	Ω
OFF-Resistance	$I_F = 0\text{ mA, } V_L = \pm 100\text{ V}$	R_{OFF}		5000		$G\Omega$
Current limit	$I_F = 5.0\text{ mA, } t = 5.0\text{ ms}$	I_{Limit}	170	210	250	mA
Output off-state leakage current	$I_F = 0\text{ mA, } V_L = \pm 100\text{ V}$	I_O		0.6	200	nA
	$I_F = 0\text{ mA, } V_L = \pm 350\text{ V}$	I_O			1.0	μA
Output capacitance pin 7 to pin 8	$I_F = 0\text{ mA, } V_L = 1.0\text{ V}$	C_O		55		pF
	$I_F = 0\text{ mA, } V_L = 50\text{ V}$	C_O		10		pF
Turn-on time	$I_F = 5.0\text{ mA, } I_L = 50\text{ mA}$	t_{on}		1.3	2.5	ms
Turn-off time	$I_F = 5.0\text{ mA, } I_L = 50\text{ mA}$	t_{off}		0.1	2.5	ms



LH1529FP/ FPTR/ GP/ GPTR

Vishay Semiconductors

Optocoupler

Parameter	Test condition	Part	Symbol	Min	Typ.	Max	Unit
LED forward voltage	$I_F = 10 \text{ mA}$		V_F	0.9	1.2	1.5	V
Saturation voltage	$I_F = 16 \text{ mA}, I_C = 2.0 \text{ mA}$		V_{CEsat}		0.07	0.5	V
Dark current leakage	$I_F = 0 \text{ mA}, V_{CE} = 5.0 \text{ V}$		I_{CEO1}			500	nA
Trickle current leakage	$I_F = 5.0 \mu\text{A}, V_{CE} = 5.0 \text{ V}$		I_{CEO2}			1.0	μA
DC Current Transfer Ratio	$I_F = 6.0 \text{ mA}, V_{CE} = 0.5 \text{ V}$	LH1529FP	CTR_{DC}	33	150		%
		LH1529GP	CTR_{DC}	100	150		%

Typical Characteristics ($T_{amb} = 25^\circ\text{C}$ unless otherwise specified)

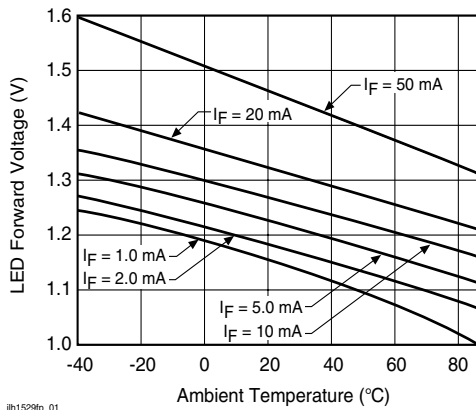

Figure 1. LED Voltage vs. Temperature

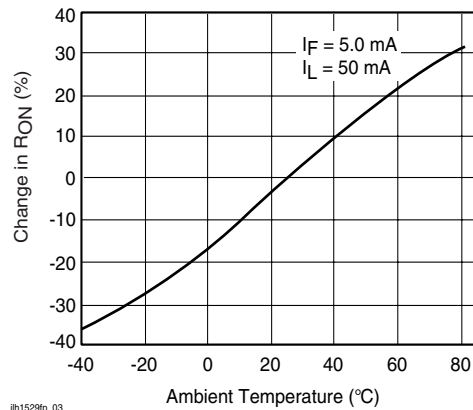

Figure 3. ON-Resistance vs. Temperature

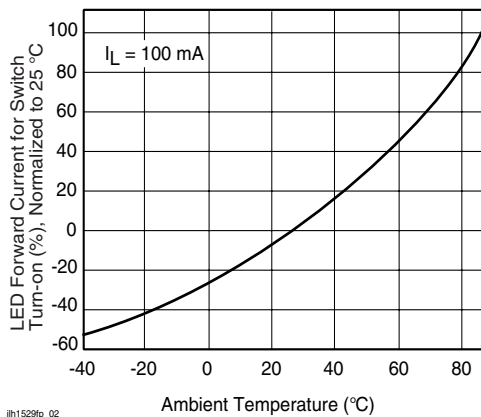

Figure 2. LED Current for Switch Turn-on vs. Temperature

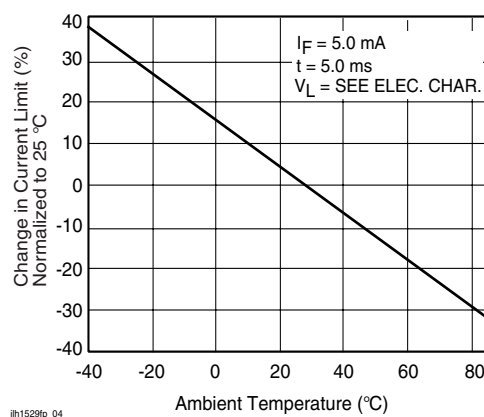
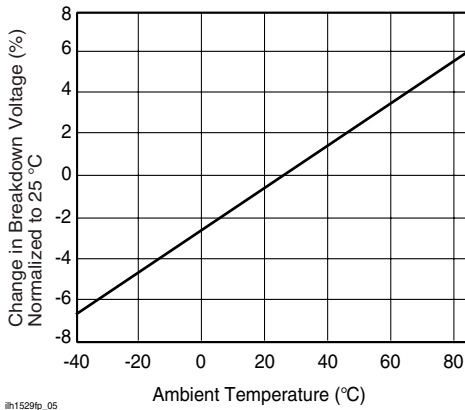

Figure 4. Current Limit vs. Temperature

LH1529FP/ FPTR/ GP/ GPTR



Vishay Semiconductors



ih1529fp_05

Figure 5. Switch Breakdown Voltage vs. Temperature

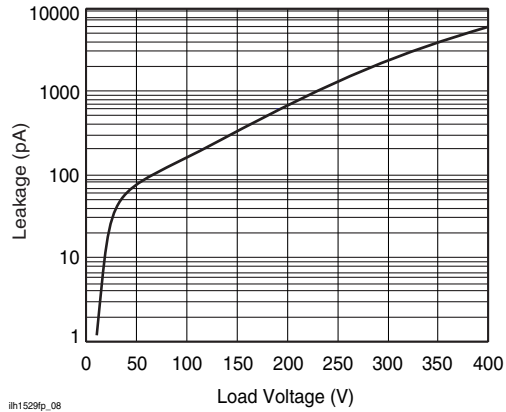

ih1529fp_08

Figure 8. Leakage Current vs. Applied Voltage

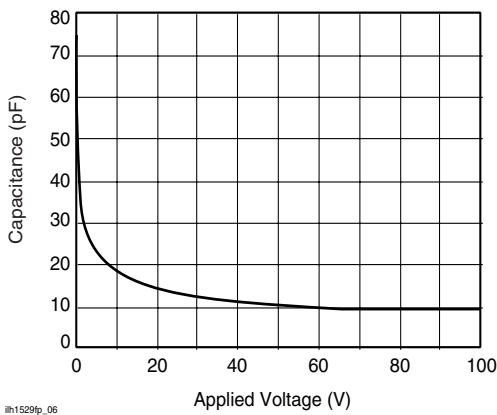

ih1529fp_06

Figure 6. Switch Capacitance vs. Applied Voltage

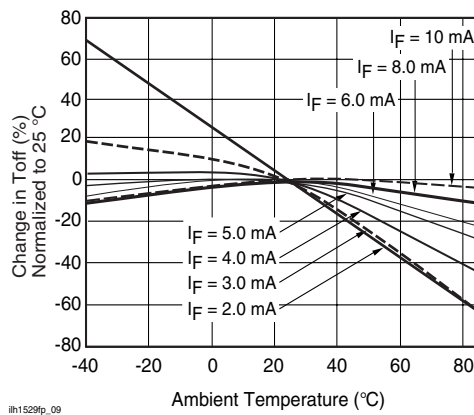

ih1529fp_09

Figure 9. Turn-off Time vs. Temperature

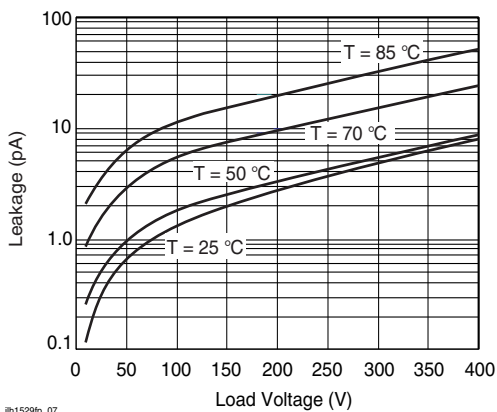

ih1529fp_07

Figure 7. Leakage Current vs. Applied Voltage

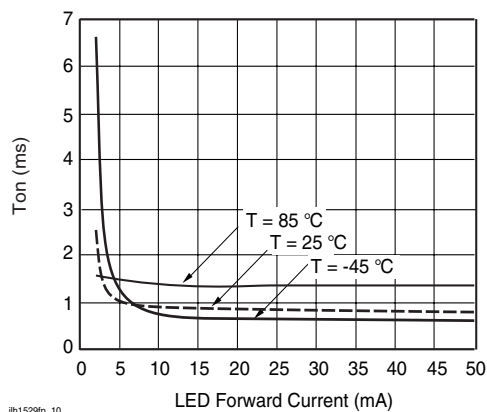

ih1529fp_10

Figure 10. Turn-on Time vs. LED Current



LH1529FP/ FPTR/ GP/ GPTR

Vishay Semiconductors

Package Dimensions in Inches (mm)

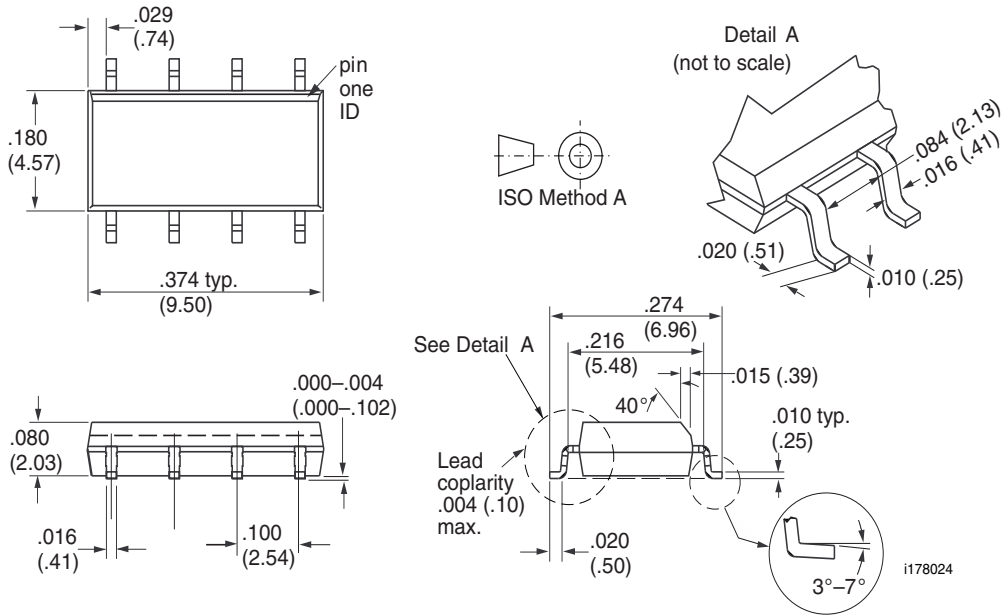



Ozone Depleting Substances Policy Statement

It is the policy of Vishay Semiconductor GmbH to

1. Meet all present and future national and international statutory requirements.
2. Regularly and continuously improve the performance of our products, processes, distribution and operating systems with respect to their impact on the health and safety of our employees and the public, as well as their impact on the environment.

It is particular concern to control or eliminate releases of those substances into the atmosphere which are known as ozone depleting substances (ODSs).

The Montreal Protocol (1987) and its London Amendments (1990) intend to severely restrict the use of ODSs and forbid their use within the next ten years. Various national and international initiatives are pressing for an earlier ban on these substances.

Vishay Semiconductor GmbH has been able to use its policy of continuous improvements to eliminate the use of ODSs listed in the following documents.

1. Annex A, B and list of transitional substances of the Montreal Protocol and the London Amendments respectively
2. Class I and II ozone depleting substances in the Clean Air Act Amendments of 1990 by the Environmental Protection Agency (EPA) in the USA
3. Council Decision 88/540/EEC and 91/690/EEC Annex A, B and C (transitional substances) respectively.

Vishay Semiconductor GmbH can certify that our semiconductors are not manufactured with ozone depleting substances and do not contain such substances.

We reserve the right to make changes to improve technical design
and may do so without further notice.

Parameters can vary in different applications. All operating parameters must be validated for each customer application by the customer. Should the buyer use Vishay Semiconductors products for any unintended or unauthorized application, the buyer shall indemnify Vishay Semiconductors against all claims, costs, damages, and expenses, arising out of, directly or indirectly, any claim of personal damage, injury or death associated with such unintended or unauthorized use.

Vishay Semiconductor GmbH, P.O.B. 3535, D-74025 Heilbronn, Germany
Telephone: 49 (0)7131 67 2831, Fax number: 49 (0)7131 67 2423