



LH1556FP/ FPTR

Vishay Semiconductors

Dual 1 Form A Solid State Relay

Features

- Solid-state Relay (Equivalent to AQW210S)
 - Typical R_{ON} 28 Ω
 - Load Voltage 350 V
 - Load Current 120 mA
 - Current Limit Protection
 - High Surge Capability
 - Clean Bounce Free Switching
 - Low Power Consumption
 - High Reliability Monolithic Detector
- Two Independent Relays in a Single Package
- Package - FLAT PAK
- Isolation Test Voltage 3000 V_{RMS}
- Lead-free component
- Component in accordance to RoHS 2002/95/EC and WEEE 2002/96/EC

Agency Approvals

- UL1577, File No. E52744 System Code S
- BSI/BABT Cert. No. 7980

Applications

General Telecom Switching

- On/off Hook Control
- Ring Relay
- Ground Start

Industrial Controls

- Triac Predriver
- Output Modules

Peripherals

- Transducer Driver

Instrumentation

- Automatic Tuning/Balancing
- Flying Capacitor
- Analog Multiplexing

See "Solid State Relays" (Application Note 56)

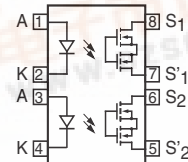
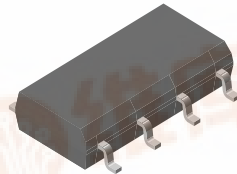

1179048

Description

The LH1556FP is robust, ideal for telecom and ground fault applications. It contains two SPST normally open switches (1 Form A) that replace electro-mechanical relays in many applications. It is constructed using a GaAs LED for actuation control and an integrated monolithic die for the switch output. The die, fabricated in a high-voltage dielectrically isolated BCDMOS technology, is comprised of a photodiode array, switch control circuitry and MOSFET switches. In addition, it employs current-limiting circuitry which meets FCC 68.302 and other regulatory voltage surge requirements when overvoltage protection is provided.

Order Information

Part	Remarks
LH1556FP	Tubes, SMD-8
LH1556FPTR	Tape and Reel, SMD-8



LH1556FP/ FPTR



Vishay Semiconductors

Absolute Maximum Ratings, $T_{amb} = 25\text{ }^{\circ}\text{C}$

Stresses in excess of the absolute Maximum Ratings can cause permanent damage to the device. Functional operation of the device is not implied at these or any other conditions in excess of those given in the operational sections of this document. Exposure to absolute Maximum Ratings for extended periods of time can adversely affect reliability.

SSR

Parameter	Test condition	Symbol	Value	Unit
LED continuous forward current		I_F	50	mA
LED reverse voltage	$I_R \leq 10\text{ }\mu\text{A}$	V_R	6.0	V
DC or peak AC load voltage	$I_L \leq 50\text{ }\mu\text{A}$	V_L	350	V
Continuous DC load current		I_L	120	mA
Ambient temperature range		T_{amb}	- 40 to + 85	$^{\circ}\text{C}$
Storage temperature range		T_{stg}	- 40 to + 125	$^{\circ}\text{C}$
Soldering temperature	$t = 10\text{ s max.}$	T_{sld}	260	$^{\circ}\text{C}$
Isolation test voltage	$t = 1.0\text{ s}$	V_{ISO}	3000	V_{RMS}
Isolation resistance	$V_{IO} = 500\text{ V, } T_{amb} = 25\text{ }^{\circ}\text{C}$	R_{IO}	$\geq 10^{12}$	Ω
	$V_{IO} = 500\text{ V, } T_{amb} = 100\text{ }^{\circ}\text{C}$	R_{IO}	$\geq 10^{11}$	Ω
Total power dissipation		P_{diss}	550	mW

Electrical Characteristics, $T_{amb} = 25\text{ }^{\circ}\text{C}$

Minimum and maximum values are testing requirements. Typical values are characteristics of the device and are the result of engineering evaluations. Typical values are for information only and are not part of the testing requirements.

Input

Parameter	Test condition	Symbol	Min	Typ.	Max	Unit
LED forward current for switch turn-on	$I_L = 100\text{ mA, } t = 10\text{ ms}$	I_{Fon}		1.1	2.0	mA
LED forward current for switch turn-off	$V_L = \pm 300\text{ V}$	I_{Foff}	0.2	0.6		mA
LED forward voltage	$I_F = 10\text{ mA}$	V_F	1.0	1.18	1.45	V
Current limit	$I_F = 5.0\text{ mA, } t = 5.0\text{ ms, } V_L = \pm 6.0\text{ V}$	I_{Limit}	170	210	250	mA

Output

Parameter	Test condition	Symbol	Min	Typ.	Max	Unit
ON-resistance, ac/dc: Pin 3 (\pm) to 4 (\pm)	$I_F = 5.0\text{ mA, } I_L = 50\text{ mA}$	R_{ON}		28	35	Ω
OFF-Resistance	$I_F = 0\text{ mA, } V_L = \pm 100\text{ V}$	R_{OFF}	0.5	300		$\text{G}\Omega$
Off-state leakage current	$I_F = 0\text{ mA, } V_L = \pm 100\text{ V}$	I_O		0.32	200	nA
	$I_F = 0\text{ mA, } V_L = \pm 350\text{ V}$	I_O			1.0	μA
Output capacitance Pin 3 to 4	$I_F = 0\text{ mA, } V_L = 1.0\text{ V}$	C_O		55		pF
	$I_F = 0\text{ mA, } V_L = 50\text{ V}$	C_O		10		pF



Transfer

Parameter	Test condition	Symbol	Min	Typ.	Max	Unit
Turn-on time	$I_F = 5.0 \text{ mA}$, $I_L = 50 \text{ mA}$	t_{on}		2.0	3.0	ms
Turn-off time	$I_F = 5.0 \text{ mA}$, $I_L = 50 \text{ mA}$	t_{off}		1.1	3.0	ms
Capacitance (input-output)	$V_{ISO} = 1.0 \text{ V}$	C_{IO}		0.6		pF

Typical Characteristics ($T_{amb} = 25^\circ\text{C}$ unless otherwise specified)

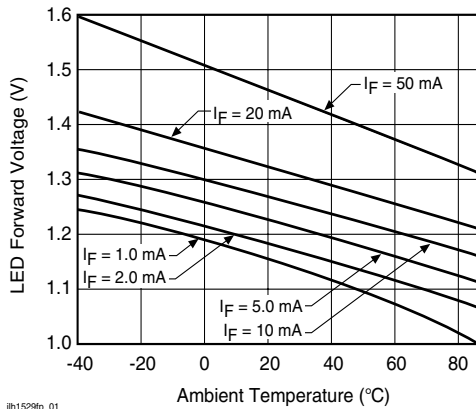

ih1529fp_01

Figure 1. LED Voltage vs. Temperature

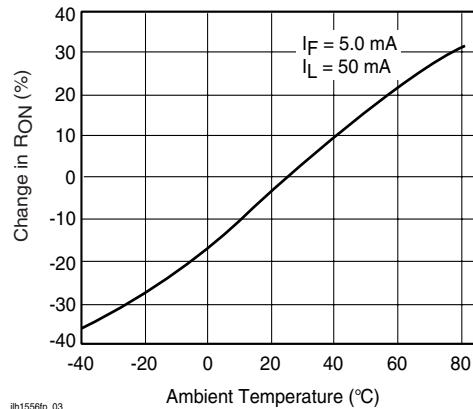

ih1556fp_03

Figure 3. ON-Resistance vs. Temperature

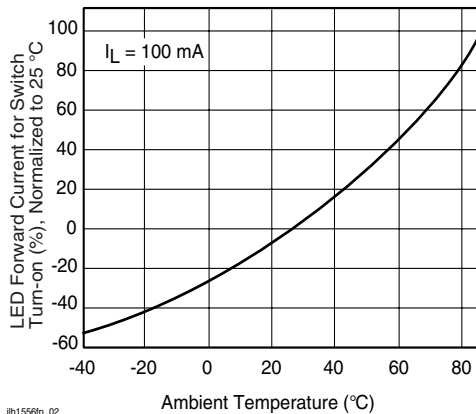

ih1556fp_02

Figure 2. LED Current for Switch Turn-on vs. Temperature

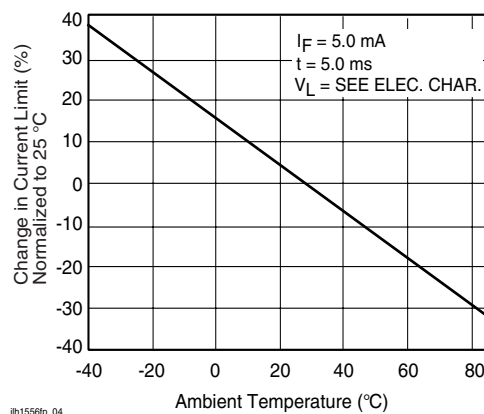

ih1556fp_04

Figure 4. Current Limit vs. Temperature

LH1556FP/ FPTR



Vishay Semiconductors

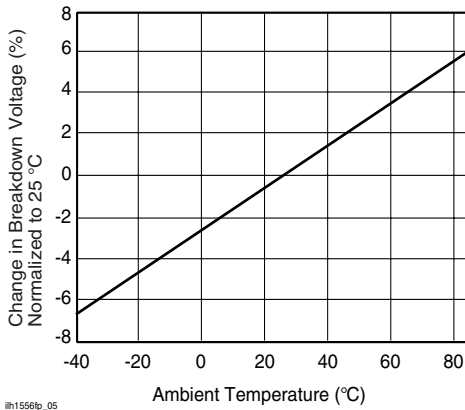

ih1556fp_05

Figure 5. Switch Breakdown Voltage vs. Temperature

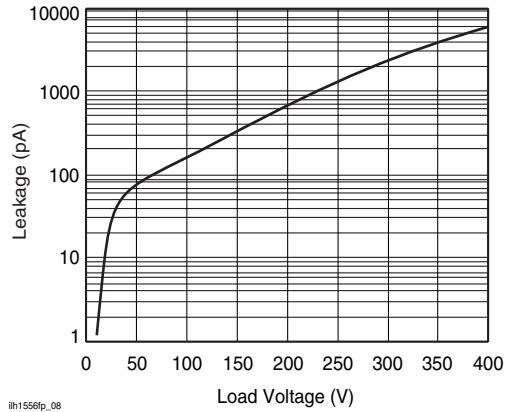

ih1556fp_08

Figure 8. Leakage Current vs. Applied Voltage

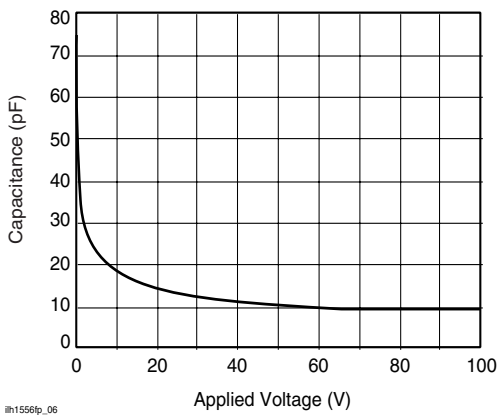

ih1556fp_06

Figure 6. Switch Capacitance vs. Applied Voltage

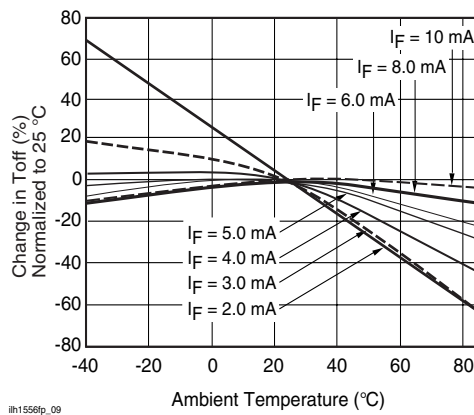

ih1556fp_09

Figure 9. Turn-off Time vs. Temperature

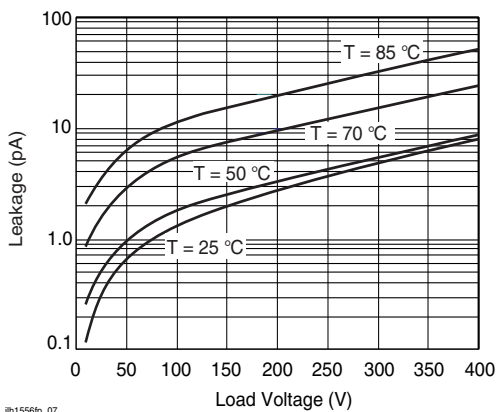

ih1556fp_07

Figure 7. Leakage Current vs. Applied Voltage

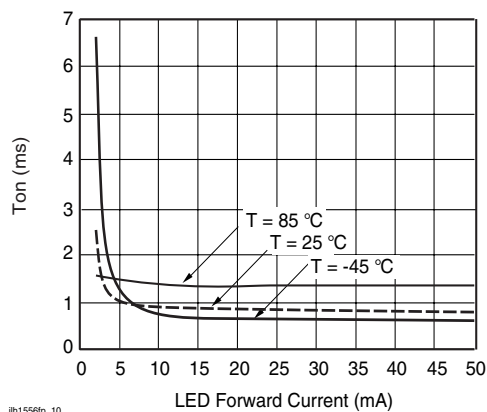

ih1556fp_10

Figure 10. Turn-on Time vs. LED Current



LH1556FP/ FPTR

Vishay Semiconductors

Package Dimensions in Inches (mm)

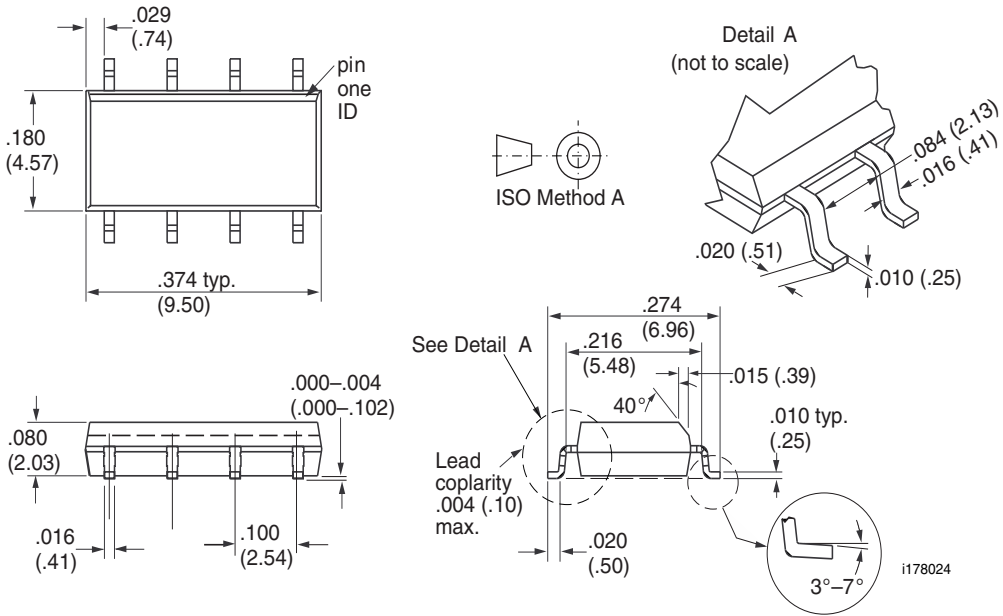

Ozone Depleting Substances Policy Statement

It is the policy of Vishay Semiconductor GmbH to

1. Meet all present and future national and international statutory requirements.
2. Regularly and continuously improve the performance of our products, processes, distribution and operating systems with respect to their impact on the health and safety of our employees and the public, as well as their impact on the environment.

It is particular concern to control or eliminate releases of those substances into the atmosphere which are known as ozone depleting substances (ODSs).

The Montreal Protocol (1987) and its London Amendments (1990) intend to severely restrict the use of ODSs and forbid their use within the next ten years. Various national and international initiatives are pressing for an earlier ban on these substances.

Vishay Semiconductor GmbH has been able to use its policy of continuous improvements to eliminate the use of ODSs listed in the following documents.

1. Annex A, B and list of transitional substances of the Montreal Protocol and the London Amendments respectively
2. Class I and II ozone depleting substances in the Clean Air Act Amendments of 1990 by the Environmental Protection Agency (EPA) in the USA
3. Council Decision 88/540/EEC and 91/690/EEC Annex A, B and C (transitional substances) respectively.

Vishay Semiconductor GmbH can certify that our semiconductors are not manufactured with ozone depleting substances and do not contain such substances.

We reserve the right to make changes to improve technical design
and may do so without further notice.

Parameters can vary in different applications. All operating parameters must be validated for each customer application by the customer. Should the buyer use Vishay Semiconductors products for any unintended or unauthorized application, the buyer shall indemnify Vishay Semiconductors against all claims, costs, damages, and expenses, arising out of, directly or indirectly, any claim of personal damage, injury or death associated with such unintended or unauthorized use.

Vishay Semiconductor GmbH, P.O.B. 3535, D-74025 Heilbronn, Germany
Telephone: 49 (0)7131 67 2831, Fax number: 49 (0)7131 67 2423