



查询LIA101供应商

# CLARE

MICRO CHIPS.  
MACRO SOLUTIONS.

捷多邦，专业PCB打样工厂，24小时加急出货

## LIA101 Linear Isolation Amplifier



### Features

- Small Size Standard 16 Pin SOIC or DIP Package
- 0.01% Servo Linearity
- 5300 VAC Peak Input/Output Isolation Available
- Bandwidth  $\geq 40\text{kHz}$
- Machine Insertable, Wave Solderable
- Wide Power Supply Range  $\pm 18\text{V}$
- Low Supply Current

### Applications

- Isolated 4-20mA Converter
- Medical Sensor Isolation
- Switching Power Supply Feedback Circuits
- Isolated Temperature/Pressure Sensors
- Data Acquisition Equipment
- Isolated Motor Controls

### Description

The LIA100 and LIA101 are linear isolation amplifiers that integrate a linear optocoupler with two op amps in a single package. They are available in a 16 Pin SOIC or DIP package.

### Approvals

- UL Recognized: File Number E76270
- CSA Certified: File Number LR 43639-10
- BSI Certified to:
  - BS EN 60950:1992 (BS7002:1992)  
Certificate #: 7344
  - BS EN 41003:1993  
Certificate #: 7344

### Ordering Information

Part #	Description
LIA101	16 Pin DIP (50/Tube)
LIA101P	16 Pin Flatpack (50/Tube)
LIA101PTR	16 Pin Flatpack (1000/Reel)

### Pin Configuration

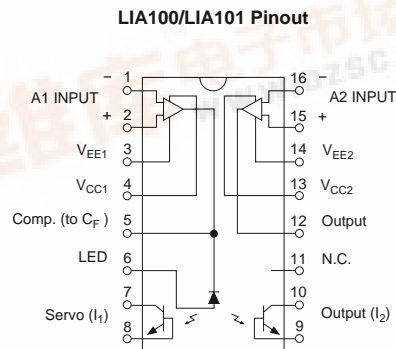



## LIA101

## Absolute Maximum Ratings (@ 25° C)

Parameter	Min	Typ	Max	Units
Supply Voltages	± 5	-	±18	V
Differential Input Voltage	-	-	± 30	V
Output Short Circuit Duration	Continuous		-	-
Total Package Dissipation	-	-	11	W
Isolation Voltage				
Input to Output	3750	-	-	V <sub>RMS</sub>
Operational Temperature	-40	-	+85	°C
Storage Temperature	-40	-	+125	°C
Soldering Temperature				
DIP Package	-	-	+260	°C
Surface Mount Package (10 Seconds Max.)	-	-	+220	°C

<sup>1</sup> Above 25°C Derate Linearly 1.67mW/°C

*Absolute Maximum Ratings are stress ratings. Stresses in excess of these ratings can cause permanent damage to the device. Functional operation of the device at these or any other conditions beyond those indicated in the operational sections of this data sheet is not implied. Exposure of the device to the absolute maximum ratings for an extended period may degrade the device and effect its reliability.*

## Electrical Characteristics @ TA = +25°C and ±VCC = 15VDC (unless otherwise specified)

PARAMETERS	CONDITIONS	MIN	TYP	MAX	UNITS
<b>Isolation</b>					
Continuous Voltage, AC	-	-	-	3750	V <sub>RMS</sub>
Input to Output Leakage Current	1000V <sub>RMS</sub> , 60Hz	-	0.2	-	µA <sub>RMS</sub>
<b>Offset Voltage</b>					
Output Offset Voltage (VOS)	R <sub>F</sub> =R <sub>IN</sub> =51KΩ, K3=1.000 Input Grounded T <sub>A</sub> =25°C	-	50	-	mV
Amplifier Input Impedance	-	-	10 <sup>12</sup>    3	-	Ω    pF
ΔVOS/ΔT Average TC of Input Offset Voltage	R <sub>S</sub> =50Ω	-	5	-	µV/°C
<b>(Input and Output Stage)</b>					
Common Mode Rejection Ratio, CMRR	60Hz, R <sub>F</sub> =1MΩ R <sub>IN</sub> =10KΩ, Gain=100	-	100	-	dB
Input Offset Voltage	R <sub>S</sub> =50Ω, T <sub>A</sub> =25°C	-	3	10	mV
Common Mode Range		±12	-	-	V
<b>Frequency Response</b>					
Bandwidth	-	-	40	-	kHz
Slew Rate	0-10V Step Input	-	0.3	-	V/µs
<b>Non-Linearity</b>					
	F <sub>0</sub> =300Hz, -10dBm	-	-	0.01	%
<b>Power Supplies</b>					
Input Stage Supply Voltage VCC1, VEE1	-	±5	-	±18	V
Output Stage Supply Voltage VCC2, VEE2	-	±5	-	±18	V
Input (A1) & Output Stage (A2) Supply Current	-	-	5	10	mA
Power Supply Rejection Ratio, PSRR	-	-	80	100	dB

**Electrical Characteristics @ TA = +25°C and  
 ±VCC = 15VDC (unless otherwise specified) (Continued)**

PARAMETERS	CONDITIONS	MIN	TYP	MAX	UNITS
<b>LED Parameters</b>					
Forward LED Current (IF)	-	-	-	20	mA
LED Forward Voltage Drop (VF)	IF=10mA	0.9	1.2	1.4	V
Reverse LED Current	VR=5V	-	-	10	µA
Reverse LED Voltage	-	-	-	5	V
<b>Coupled Characteristics</b>					
K1, Servo Gain (I1/IF)	IF=2-10mA, VCC=15V	0.004	0.008	0.030	
K2, Forward Gain (I2/IF)	IF=2-10mA, VCC=15V	0.004	0.008	0.030	
K3, Transfer Gain (K2/K1)	IF=2-10mA, VCC=15V	0.733	1.000	1.072	
K3, Temperature Coefficient	Over Temperature Range	-	0.005	-	%/°C
<b>Temperature Range</b>					
Operating	-	-40	-	+85	°C
Storage	-	-40	-	+125	°C

**K3 Sorted Bins**

Bin A	=	0.550-0.605
Bin B	=	0.606-0.667
Bin C	=	0.668-0.732
Bin D	=	0.733-0.805
Bin E	=	0.806-0.886
Bin F	=	0.887-0.974
Bin G	=	0.975-1.072
Bin H	=	1.073-1.179
Bin I	=	1.180-1.297
Bin J	=	1.298-1.426

- The LIA101 Series (through hole) is shipped in anti-static tubes of 25 pieces. The LIA100P Series (flatpack) is shipped in anti-static tubes of 50 pieces. Each tube will contain one K3 sorted bin.
- Bin designation marked on each device (A-J).
- Orders for the LIA100/LIA100P product will be shipped using bins available at the date of the order. Any bin (A-J) can be shipped.
- For customers requiring selected bins D E F G we offer part numbers LIA101/LIA101P.

PERFORMANCE DATA\*

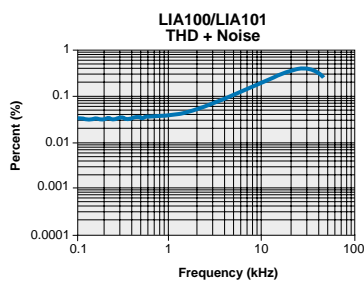
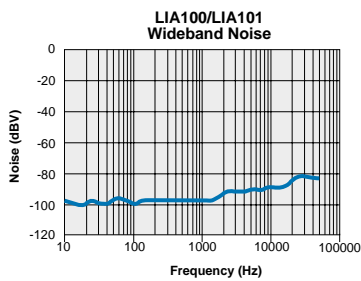
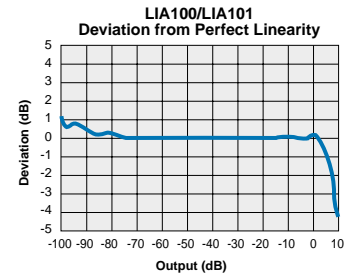
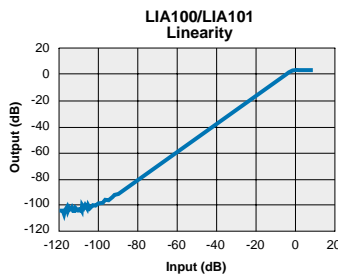
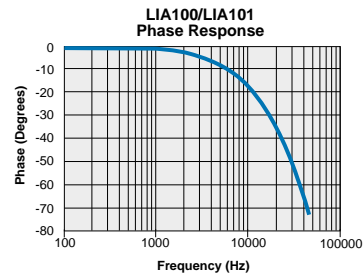
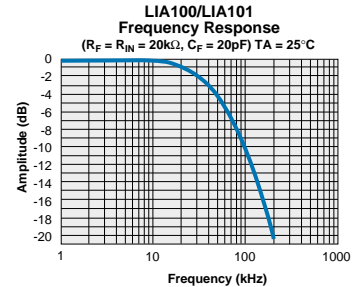
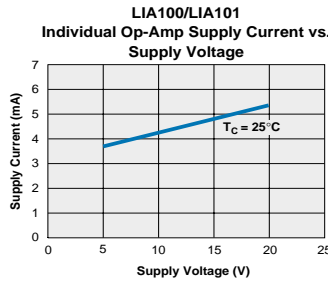
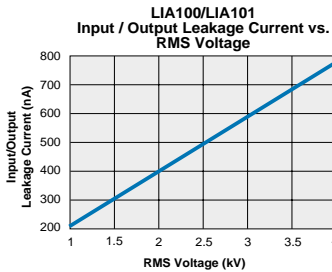
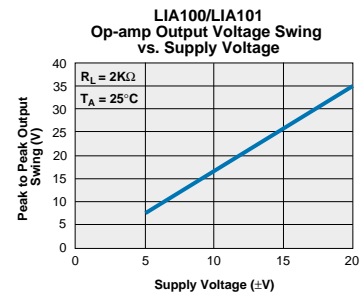
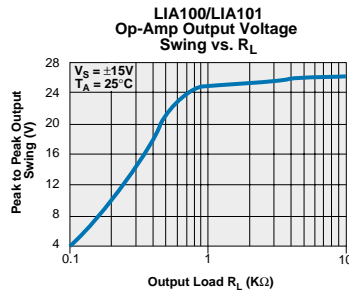
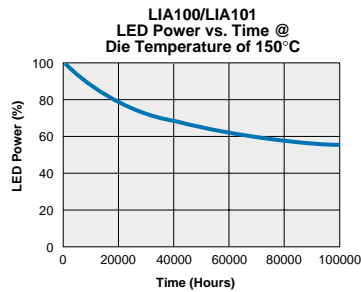
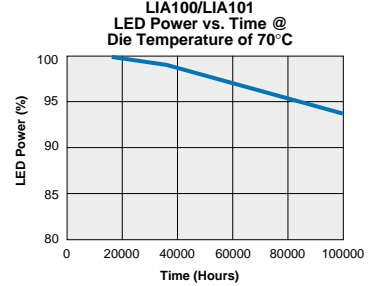
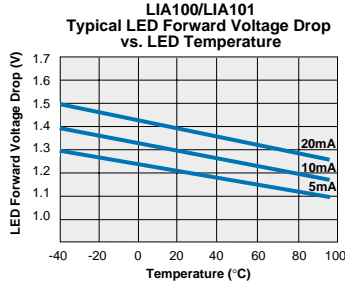
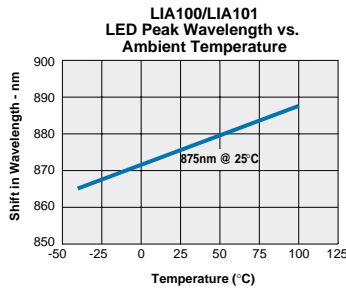

The Performance data shown in the graphs above is typical of device performance. For guaranteed parameters not indicated in the written specifications, please contact our application department.

### Mechanical Dimensions

#### 16 Pin DIP Through Hole (Standard)

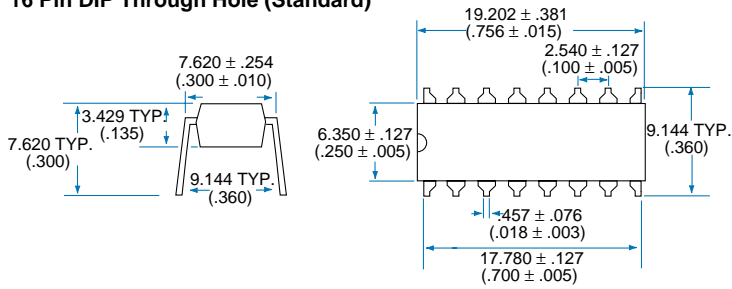

#### PC Board Pattern (Top View)

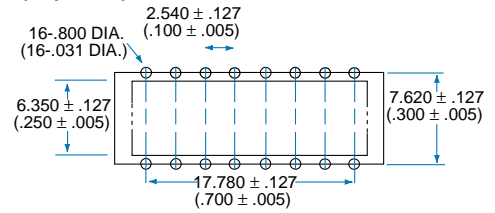

#### 16 Pin SOIC ("P" Suffix)

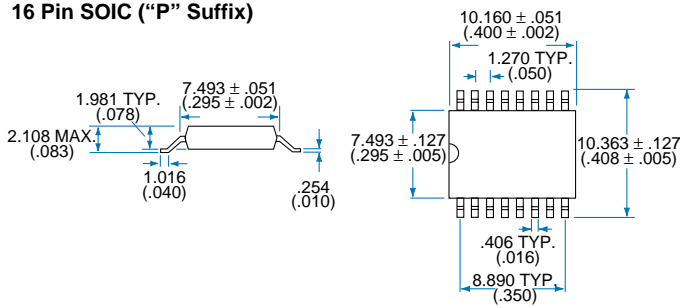

#### PC Board Pattern (Top View)

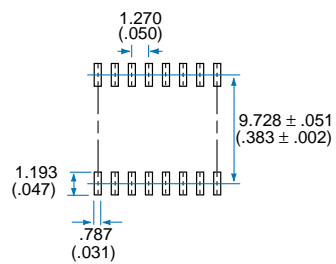

#### Tape and Reel Packaging for 16 Pin SOIC Package

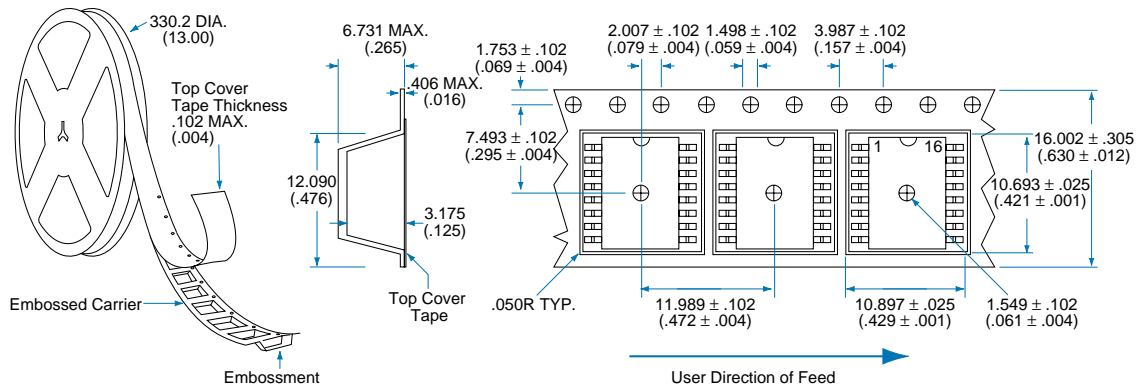



**CLARE**

MICRO CHIPS.  
MACRO SOLUTIONS.

## Worldwide Sales Offices

### CLARE LOCATIONS

Clare Headquarters  
78 Cherry Hill Drive  
Beverly, MA 01915  
Tel: 1-978-524-6700  
Fax: 1-978-524-4900  
Toll Free: 1-800-27-CLARE

Clare Micronix Division  
145 Columbia  
Aliso Viejo, CA 92656-1490  
Tel: 1-949-831-4622  
Fax: 1-949-831-4628

### SALES OFFICES

#### AMERICAS

##### Americas Headquarters

Clare  
78 Cherry Hill Drive  
Beverly, MA 01915  
Tel: 1-978-524-6700  
Fax: 1-978-524-4900  
Toll Free: 1-800-27-CLARE

##### Eastern Region

Clare  
P.O. Box 856  
Mahwah, NJ 07430  
Tel: 1-201-236-0101  
Fax: 1-201-236-8685  
Toll Free: 1-800-27-CLARE

##### Central Region

Clare Canada Ltd.  
3425 Harvester Road, Suite 202  
Burlington, Ontario L7N 3N1  
Tel: 1-905-333-9066  
Fax: 1-905-333-1824

##### Western Region

Clare  
1852 West 11th Street, #348  
Tracy, CA 95376  
Tel: 1-209-832-4367  
Fax: 1-209-832-4732  
Toll Free: 1-800-27-CLARE

##### Canada

Clare Canada Ltd.  
3425 Harvester Road, Suite 202  
Burlington, Ontario L7N 3N1  
Tel: 1-905-333-9066  
Fax: 1-905-333-1824

### EUROPE

#### European Headquarters

CP Clare nv  
Bampslaan 17  
B-3500 Hasselt (Belgium)  
Tel: 32-11-300868  
Fax: 32-11-300890

#### France

Clare France Sales  
Lead Rep  
99 route de Versailles  
91160 Champlan  
France  
Tel: 33 1 69 79 93 50  
Fax: 33 1 69 79 93 59

#### Germany

Clare Germany Sales  
ActiveComp Electronic GmbH  
Mitterstrasse 12  
85077 Manching  
Germany  
Tel: 49 8459 3214 10  
Fax: 49 8459 3214 29

#### Italy

C.L.A.R.E.s.a.s.  
Via C. Colombo 10/A  
I-20066 Melzo (Milano)  
Tel: 39-02-95737160  
Fax: 39-02-95738829

#### Sweden

Clare Sales  
Comptronic AB  
Box 167  
S-16329 Spånga  
Tel: 46-862-10370  
Fax: 46-862-10371

#### United Kingdom

Clare UK Sales  
Marco Polo House  
Cook Way  
Bindon Road  
Taunton  
UK-Somerset TA2 6BG  
Tel: 44-1-823 352541  
Fax: 44-1-823 352797

### ASIA/PACIFIC

#### Asian Headquarters

Clare  
Room N1016, Chia-Hsin, Bldg II,  
10F, No. 96, Sec. 2  
Chung Shan North Road  
Taipei, Taiwan R.O.C.  
Tel: 886-2-2523-6368  
Fax: 886-2-2523-6369

<http://www.clare.com>

*Clare cannot assume responsibility for use of any circuitry other than circuitry entirely embodied in this Clare product. No circuit patent licenses nor indemnity are expressed or implied. Clare reserves the right to change the specification and circuitry, without notice at any time. The products described in this document are not intended for use in medical implantation or other direct life support applications where malfunction may result in direct physical harm, injury or death to a person.*