



LM1035/LM1036 Dual DC Operated Tone/Volume/Balance Circuits

General Description

The LM1035/LM1036 is a DC controlled tone (bass/treble), volume and balance circuit for stereo applications in car radio, TV and audio systems. An additional control input allows loudness compensation to be simply effected.

Four control inputs provide control of the bass, treble, balance and volume functions through application of DC voltages from a remote control system or, alternatively, from four potentiometers which may be biased from a zener regulated supply provided on the circuit.

Each tone response is defined by a single capacitor chosen to give the desired characteristic.

Features

- Wide supply voltage range, 8V to 18V
- Large volume control range, 75 dB typical
- Tone control, ± 15 dB typical
- Channel separation, 75 dB typical
- Low distortion, 0.06% typical for an input level of 1 Vrms (0.3 Vrms for LM1036)
- High signal to noise, 80 dB typical for an input level of 1 Vrms (0.3 Vrms for LM1036)
- Few external components required

Block and Connection Diagram

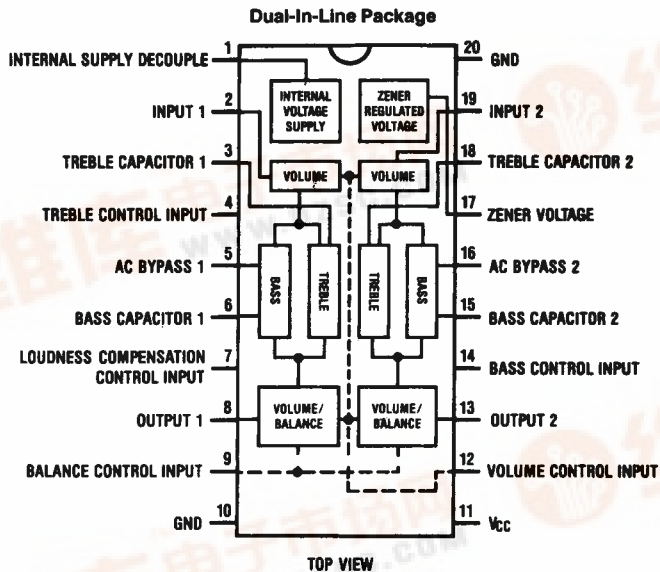

Order Number LM1035N or LM1036N
See NS Package Number N20A

TL/H/5142-1

Absolute Maximum Ratings

If Military/Aerospace specified devices are required, please contact the National Semiconductor Sales Office/Distributors for availability and specifications.

Supply Voltage	
LM1036	16V
LM1035	20V
Control Pin Voltage (Pins 4, 7, 9, 12, 14)	V_{CC}

Operating Temperature Range	0°C to +70°C
Storage Temperature Range	-65°C to +150°C
Power Dissipation	1W
Lead Temp. (Soldering, 10 seconds)	260°C

Electrical Characteristics $V_{CC} = 12V$, $T_A = 25^\circ C$ (unless otherwise stated)

Parameter	Conditions	Min	Typ	Max	Units
Supply Voltage Range	Pin 11	LM1036	9	16	V
		LM1035	8	18	V
Supply Current			35	45	mA
Zener Regulated Output Voltage Current	Pin 17		5.4		V
				5	mA
Maximum Output Voltage LM1036	Pins 8, 13; $f = 1$ kHz $V_{CC} = 9V$, Maximum Gain $V_{CC} = 12V$	0.8	0.8 1.0		Vrms Vrms
Maximum Output Voltage LM1035	Pins 8, 13; $f = 1$ kHz $V_{CC} = 8V$ $V_{CC} = 12V$ $V_{CC} = 18V$		1.3		Vrms
			2	2.5	Vrms
				3.5	Vrms
Maximum Input Voltage LM1036 (Note 1)	Pins 2, 19; $f = 1$ kHz, $V_{CC} = 9V$ Flat Response, $V_{CC} = 12V$ Gain = -10 dB	1.3	1.1 1.6		Vrms Vrms
Maximum Input Voltage LM1035 (Note 1)	Pins 2, 19; $f = 1$ kHz Flat Response	2	2.5		Vrms
Input Resistance	Pins 2, 19; $f = 1$ kHz	20	30		k Ω
Output Resistance	Pins 8, 13; $f = 1$ kHz		20		Ω
Maximum Gain	$V(\text{Pin } 12) = V(\text{Pin } 17)$; $f = 1$ kHz	-2	0	2	dB
Volume Control Range	$f = 1$ kHz	LM1036	70	75	dB
		LM1035	70	80	dB
Gain Tracking Channel 1-Channel 2	$f = 1$ kHz 0 dB through -40 dB -40 dB through -60 dB		1	3	dB
			2		dB
Balance Control Range	Pins 8, 13; $f = 1$ kHz		1 -26	-20	dB dB
Bass Control Range (Note 2)	$f = 40$ Hz, $C_b = 0.39$ μF $V(\text{Pin } 14) = V(\text{Pin } 17)$ $V(\text{Pin } 14) = 0V$	12	15	18	dB
		-12	-15	-18	dB
Treble Control Range (Note 2)	$f = 16$ kHz, $C_t = 0.01$ μF $V(\text{Pin } 4) = V(\text{Pin } 17)$ $V(\text{Pin } 4) = 0V$	12	15	18	dB
		-12	-15	-18	dB
Total Harmonic Distortion LM1036	$f = 1$ kHz, $V_{IN} = 0.3$ Vrms Gain = 0 dB Gain = -30 dB		0.06	0.3	%
			0.03		%
Total Harmonic Distortion LM1035	$f = 1$ kHz, $V_{IN} = 1$ Vrms Maximum Gain		0.05	0.2	%

Electrical Characteristics $V_{CC} = 12V$, $T_A = 25^\circ C$ (unless otherwise stated) (Continued)

Parameter	Conditions	Min	Typ	Max	Units	
Channel Separation	f = 1 kHz, Maximum Gain	LM1036	60	75		dB
		LM1035		75		dB
Signal/Noise Ratio LM1036	Unweighted 100 Hz–20 kHz Maximum Gain, 0 dB = 0.3 Vrms CCIR/ARM (Note 3) Gain = 0 dB, $V_{IN} = 0.3$ Vrms Gain = –20 dB, $V_{IN} = 1.0$ Vrms			80		dB
		75	79	72		dB
Signal/Noise Ratio LM1035	Unweighted 100 Hz–20 kHz Maximum Gain, 0 dB = 1 Vrms CCIR/ARM (Note 3) Gain = 0 dB Gain = –20 dB			80		dB
		76	80	64		dB
Output Noise Voltage at Minimum Gain	CCIR/ARM (Note 3)	LM1036		10	16	μV
		LM1035		25	35	μV
Supply Ripple Rejection	200 mVrms, 1 kHz Ripple	LM1036	35	50		dB
		LM1035		40		dB
Control Input Currents	Pins 4, 7, 9, 12, 14 ($V = 0V$)		–0.6	–2.5	μA	
Frequency Response	–1 dB (Flat Response 20 Hz–16 kHz)		250		kHz	

Note 1: The maximum permissible input level is dependent on tone and volume settings. See Application Notes.

Note 2: The tone control range is defined by capacitors C_b and C_t . See Application Notes.

Note 3: Gaussian noise, measured over a period of 50 ms per channel, with a CCIR filter referenced to 2 kHz and an average-responding meter.

Typical Performance Characteristics

Volume Control Characteristics

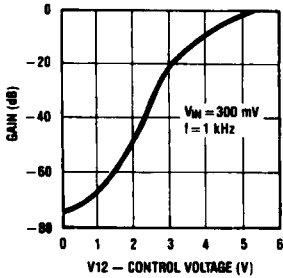

Balance Control Characteristic

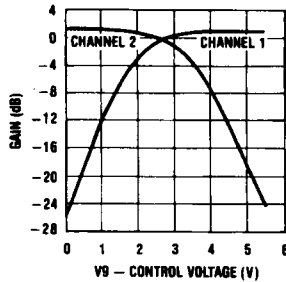

Tone Control Characteristic

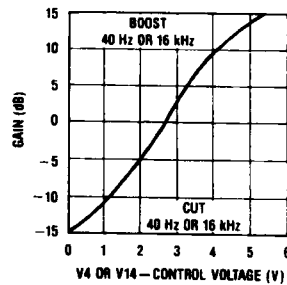

Tone Characteristic (Gain vs Frequency)

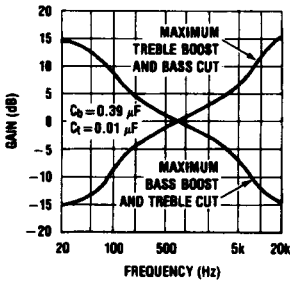

Tone Characteristic (Gain vs Frequency)

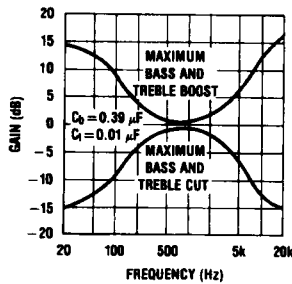

Loudness Compensated Volume Characteristic

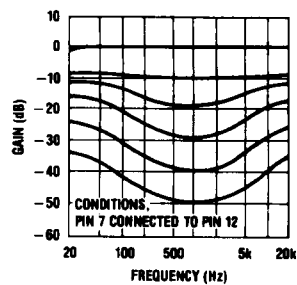

Input Signal Handling vs Supply Voltage

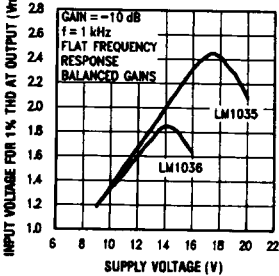

THD vs Gain

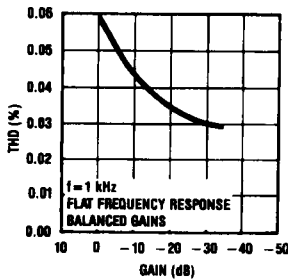

Channel Separation vs Frequency

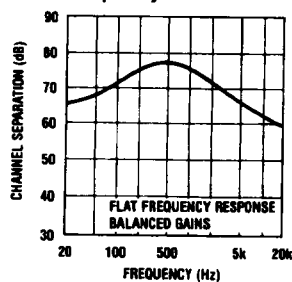

Loudness Control Characteristic

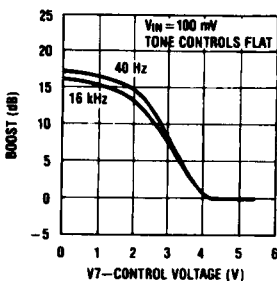

Output Noise Voltage vs Gain—LM1036

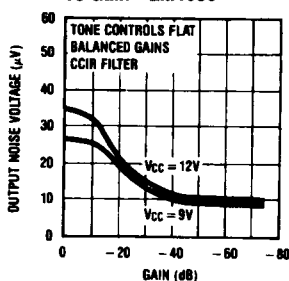

THD vs Input Voltage—LM1036

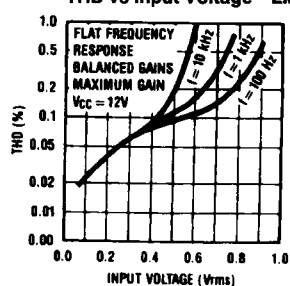

Typical Performance Characteristics (Continued)

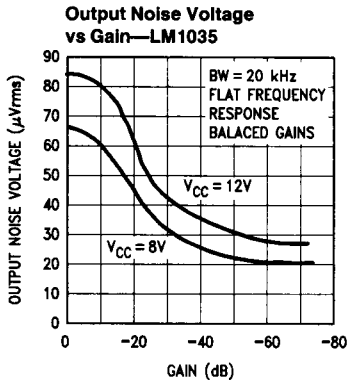

TL/H/5142-20

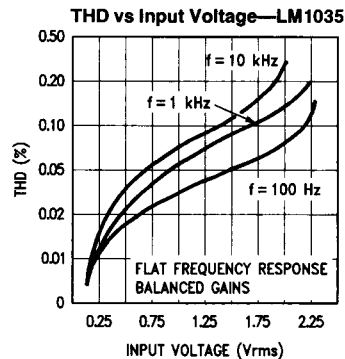

TL/H/5142-21

Application Notes

TONE RESPONSE

The maximum boost and cut can be optimized for individual applications by selection of the appropriate values of C_t (treble) and C_b (bass).

The tone responses are defined by the relationships:

$$\text{Bass Response} = \frac{1 + \frac{0.00065(1 - a_b)}{j\omega C_b}}{1 + \frac{0.00065a_b}{j\omega C_b}}$$

$$\text{Treble Response} = \frac{1 + j\omega 5500(1 - a_t)C_t}{1 + j\omega 5500a_t C_t}$$

Where $a_b = a_t = 0$ for maximum bass and treble boost respectively and $a_b = a_t = 1$ for maximum cut.

For the values of C_b and C_t of $0.39\ \mu\text{F}$ and $0.01\ \mu\text{F}$ as shown in the Application Circuit, 15 dB of boost or cut is obtained at 40 Hz and 16 kHz.

ZENER VOLTAGE

A zener voltage (pin 17 = 5.4V) is provided which may be used to bias the control potentiometers. Setting a DC level of one half of the zener voltage on the control inputs, pins 4, 9, and 14, results in the balanced gain and flat response condition. Typical spread on the zener voltage is $\pm 100\ \text{mV}$ and this must be taken into account if control signals are used which are not referenced to the zener voltage. If this is the case, then they will need to be derived with similar accuracy.

LOUDNESS COMPENSATION

A simple loudness compensation may be effected by applying a DC control voltage to pin 7. This operates on the tone control stages to produce an additional boost limited by the maximum boost defined by C_b and C_t . There is no loudness compensation when pin 7 is connected to pin 17. Pin 7 can be connected to pin 12 to give the loudness compensated volume characteristic as illustrated without the addition of further external components. (Tone settings are for flat response, C_b and C_t as given in Application Circuit.) Modification to the loudness characteristic is possible by changing the capacitors C_b and C_t for a different basic response or, by a resistor network between pins 7 and 12 for a different threshold and slope.

SIGNAL HANDLING

The volume control function of the LM1036 is carried out in two stages, controlled by the DC voltage on pin 12, to improve signal handling capability and provide a reduction of output noise level at reduced gain. The first stage is before the tone control processing and provides an initial 15 dB of gain reduction, so ensuring that the tone sections are not overdriven by large input levels when operating with a low volume setting. Any combination of tone and volume settings may be used provided the output level does not exceed 1 Vrms, $V_{CC} = 12\text{V}$ (0.8 Vrms, $V_{CC} = 9\text{V}$). At reduced gain ($< -6\ \text{dB}$) the input stage will overload if the input level exceeds 1.6 Vrms, $V_{CC} = 12\text{V}$ (1.1 Vrms, $V_{CC} = 9\text{V}$). As there is volume control on the input stages, the inputs may be operated with a lower overload margin than would otherwise be acceptable, allowing a possible improvement in signal to noise ratio.

Application Circuit

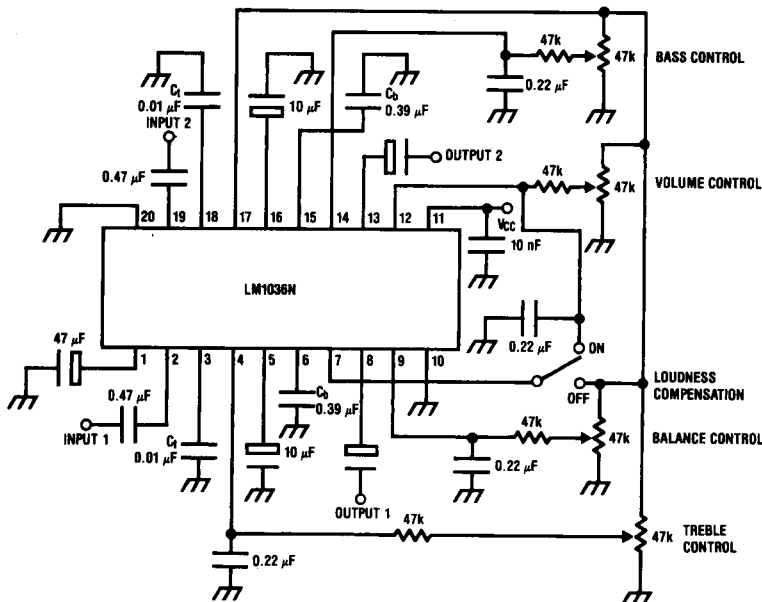

TL/H/5142-3

Applications Information

OBTAINING MODIFIED RESPONSE CURVES

The LM1036 is a dual DC controlled bass, treble, balance and volume integrated circuit ideal for stereo audio systems. In the various applications where the LM1036 can be used, there may be requirements for responses different to those of the standard application circuit given in the data sheet. This application section details some of the simple variations possible on the standard responses, to assist the choice of optimum characteristics for particular applications.

TONE CONTROLS

Summarizing the relationship given in the data sheet, basically for an increase in the treble control range C_1 must be increased, and for increased bass range C_2 must be reduced.

Figure 1 shows the typical tone response obtained in the standard application circuit. ($C_1=0.01 \mu\text{F}$, $C_2=0.39 \mu\text{F}$). Response curves are given for various amounts of boost and cut.

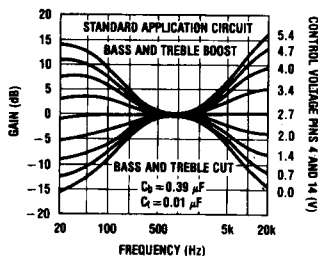

TL/H/5142-4

FIGURE 1. Tone Characteristic (Gain vs Frequency)

Figures 2 and 3 show the effect of changing the response defining capacitors C_1 and C_2 to $2C_1$, $C_2/2$ and $4C_1$, $C_2/4$ respectively, giving increased tone control ranges. The values of the bypass capacitors may become significant and affect the lower frequencies in the bass response curves.

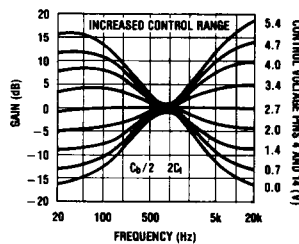

TL/H/5142-5

FIGURE 2. Tone Characteristic (Gain vs Frequency)

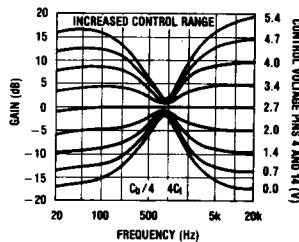

TL/H/5142-6

FIGURE 3. Tone Characteristic (Gain vs Frequency)

Applications Information (Continued)

Figure 4 shows the effect of changing C_t and C_b in the opposite direction to $C_t/2$, $2C_b$ respectively giving reduced control ranges. The various results corresponding to the different C_t and C_b values may be mixed if it is required to give a particular emphasis to, for example, the bass control. The particular case with $C_b/2$, C_t is illustrated in Figure 5.

Restriction of Tone Control Action at High or Low Frequencies

It may be desired in some applications to level off the tone responses above or below certain frequencies for example to reduce high frequency noise.

This may be achieved for the treble response by including a resistor in series with C_t . The treble boost and cut will be 3 dB less than the standard circuit when $R = X_C$.

A similar effect may be obtained for the bass response by reducing the value of the AC bypass capacitors on pins 5 (channel 1) and 16 (channel 2). The internal resistance at these pins is $1.3 \text{ k}\Omega$ and the bass boost/cut will be approximately 3 dB less with X_C at this value. An example of such modified response curves is shown in Figure 6. The input coupling capacitors may also modify the low frequency response.

It will be seen from Figures 2 and 3 that modifying C_t and C_b

for greater control range also has the effect of flattening the tone control extremes and this may be utilized, with or without additional modification as outlined above, for the most suitable tone control range and response shape.

Other Advantages of DC Controls

The DC controls make the addition of other features easy to arrange. For example, the negative-going peaks of the output amplifiers may be detected below a certain level, and used to bias back the bass control from a high boost condition, to prevent overloading the speaker with low frequency components.

LOUDNESS CONTROL

The loudness control is achieved through control of the tone sections by the voltage applied to pin 7; therefore, the tone and loudness functions are not independent. There is normally 1 dB more bass than treble boost (40 Hz–16 kHz) with loudness control in the standard circuit. If a greater difference is desired, it is necessary to introduce an offset by means of C_t or C_b or by changing the nominal control voltage ranges.

Figure 7 shows the typical loudness curves obtained in the standard application circuit at various volume levels ($C_b = 0.39 \text{ }\mu\text{F}$).

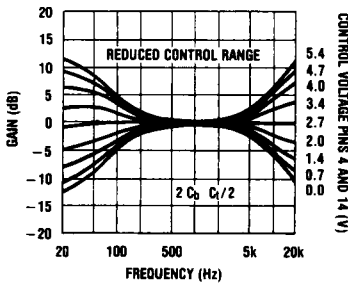

FIGURE 4. Tone Characteristic (Gain vs Frequency) TL/H/5142-7

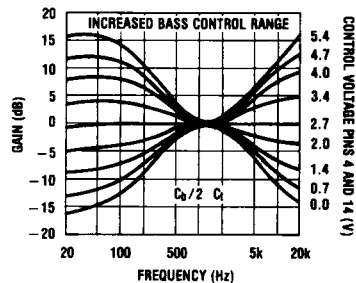

FIGURE 5. Tone Characteristic (Gain vs Frequency) TL/H/5142-8

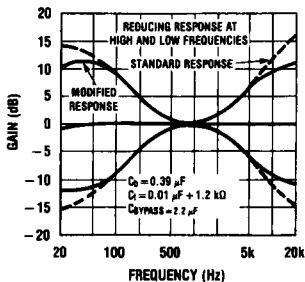

FIGURE 6. Tone Characteristic (Gain vs Frequency) TL/H/5142-9

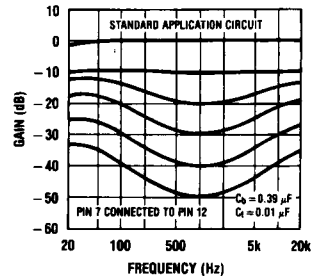

FIGURE 7. Loudness Compensated Volume Characteristic TL/H/5142-10

Applications Information (Continued)

Figures 8 and 9 illustrate the loudness characteristics obtained with C_b changed to $C_b/2$ and $C_b/4$ respectively, C_t being kept at the nominal $0.01 \mu\text{F}$. These values naturally modify the bass tone response as in Figures 2 and 3.

With pins 7 (loudness) and 12 (volume) directly connected, loudness control starts at typically -8 dB volume, with most of the control action complete by -30 dB .

Figures 10 and 11 show the effect of resistively offsetting the voltage applied to pin 7 towards the control reference voltage (pin 17). Because the control inputs are high imped-

ance, this is easily done and high value resistors may be used for minimal additional loading. It is possible to reduce the rate of onset of control to extend the active range to -50 dB volume control and below.

The control on pin 7 may also be divided down towards ground bringing the control action on earlier. This is illustrated in Figure 12. With a suitable level shifting network between pins 12 and 7, the onset of loudness control and its rate of change may be readily modified.

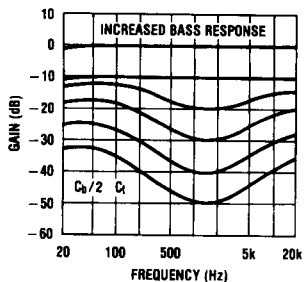

TL/H/5142-11

FIGURE 8. Loudness Compensated Volume Characteristic

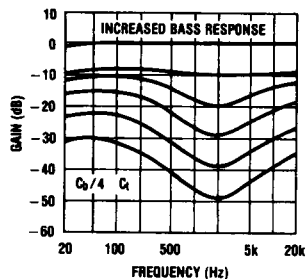

TL/H/5142-12

FIGURE 9. Loudness Compensated Volume Characteristic

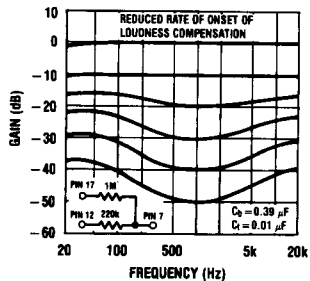

TL/H/5142-13

FIGURE 10. Loudness Compensated Volume Characteristic

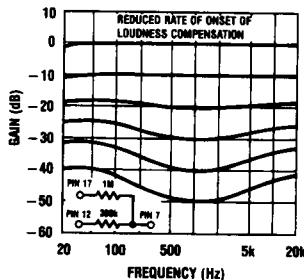

TL/H/5142-14

FIGURE 11. Loudness Compensated Volume Characteristic

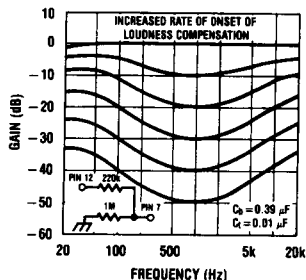

TL/H/5142-15

FIGURE 12. Loudness Compensated Volume Characteristic

Applications Information (Continued)

When adjusted for maximum boost in the usual application circuit, the LM1036 cannot give additional boost from the loudness control with reducing gain. If it is required, some additional boost can be obtained by restricting the tone control range and modifying C_t , C_b , to compensate. A circuit illustrating this for the case of bass boost is shown in *Figure 13*. The resulting responses are given in *Figure 14* showing the continuing loudness control action possible with bass boost previously applied.

USE OF THE LM1036 ABOVE AUDIO FREQUENCIES

The LM1036 has a basic response typically 1 dB down at 250 kHz (tone controls flat) and therefore by scaling C_b and C_t , it is possible to arrange for operation over a wide frequency range for possible use in wide band equalization applications. As an example *Figure 15* shows the responses obtained centered on 10 kHz with $C_b = 0.039 \mu\text{F}$ and $C_t = 0.001 \mu\text{F}$.

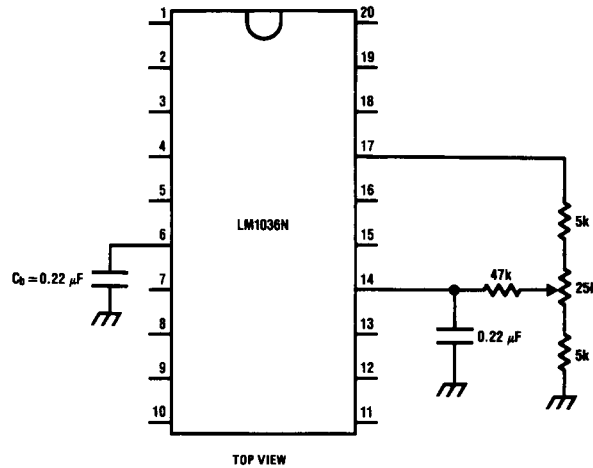

TOP VIEW

TL/H/5142-16

FIGURE 13. Modified Application Circuit for Additional Bass Boost with Loudness Control

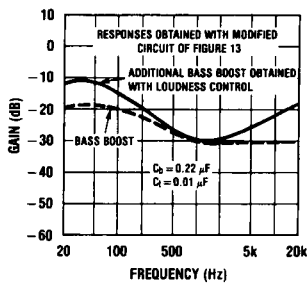

TL/H/5142-17

FIGURE 14. Loudness Compensated Volume Characteristic

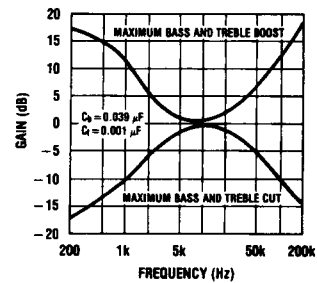

TL/H/5142-18

FIGURE 15. Tone Characteristic (Gain vs Frequency)

Simplified Schematic Diagram (One Channel)

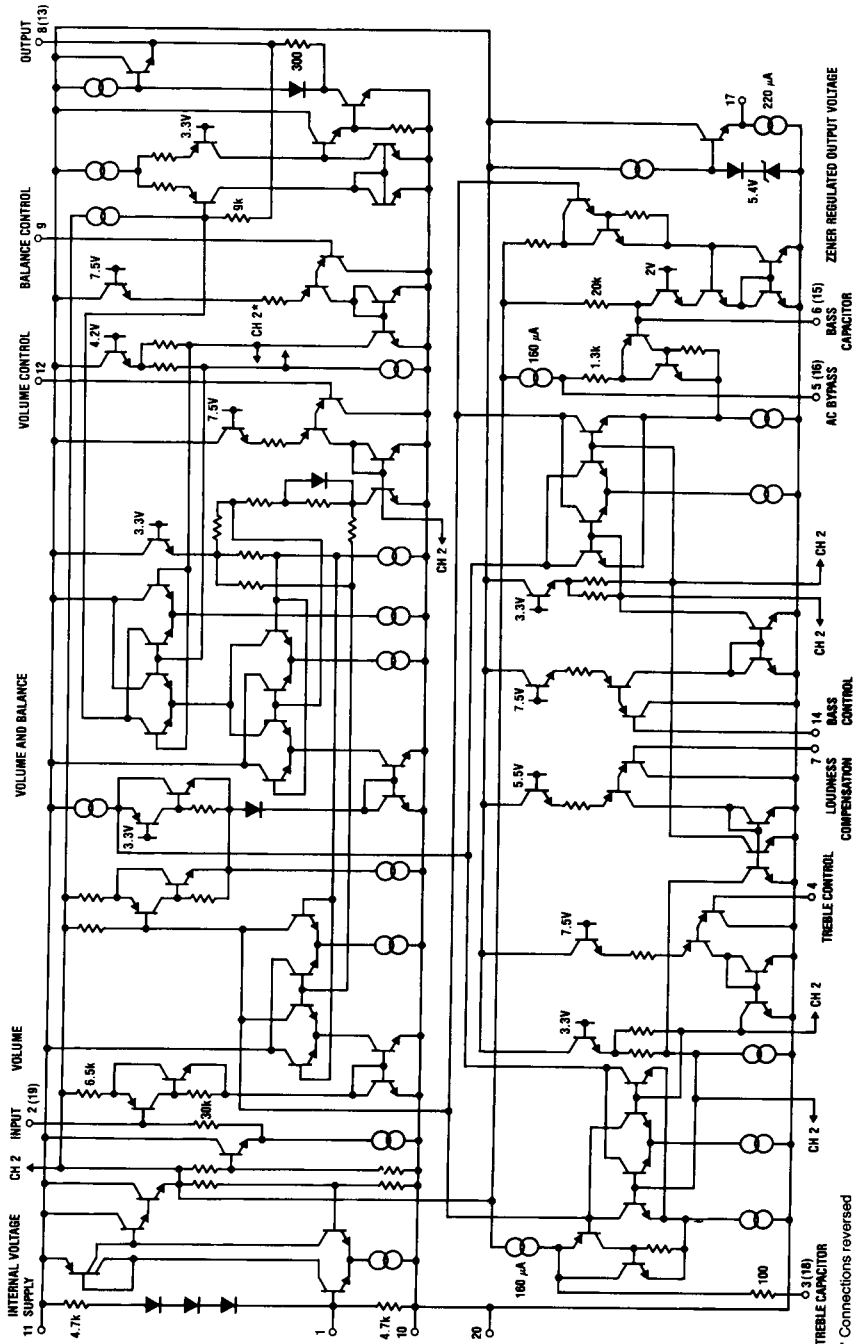

TREBLE CAPACITOR
* Connections reversed