



June 1999

## LM6511 180 ns 3V Comparator

### General Description

The LM6511 voltage comparator is ideal for analog-digital interface circuitry when only a +3V or +3.3V supply is available. The open-collector output permits signal compatibility with a wide variety of digital families: +5V CMOS, +3V CMOS, TTL and so on. Supply voltage may range from 2.7V to 36V between supply voltage leads. The LM6511 operates with little power consumption ( $P_{diss} < 9.45 \text{ mW}$  at  $V^+ = +2.7\text{V}$  and  $V^- = 0\text{V}$ ).

This voltage comparator offers many features that are available in traditional sub-microsecond comparators: output sync strobe, inputs and output may be isolated from system ground, and wire-ORing. Also, the LM6511 uses the industry-standard, single comparator pinout configuration.

### Features

(Typical unless otherwise noted)

- Operates at +2.7V, +3V, +3.3V, +5V
- Low Power consumption  $< 9.45 \text{ mW}$  @  $V^+ = 2.7\text{V}$  (max)
- Fast Response Time of 180 ns

### Applications

- Portable Equipment
- Cellular Phones
- Digital Level Shifting

### Connection Diagram

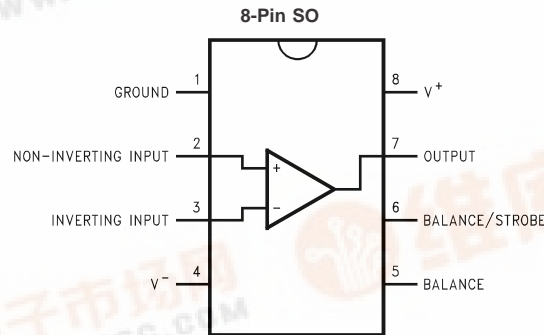

### Ordering Information

Package	Industrial Temperature Range -40°C to +85°C	NSC Package Drawing
8-Pin Small Outline	LM6511IM	M08A

LM6511 180 ns 3V Comparator



## Absolute Maximum Ratings (Note 1)

If Military/Aerospace specified devices are required, please contact the National Semiconductor Sales Office/ Distributors for availability and specifications.

Supply Voltage	-0.3 to +36V
Output to Negative Supply Voltage	50V
Ground to Negative Supply Voltage	30V
Differential Input Voltage	±30V
Input Voltage	(Note 2)
Storage Temperature Range	-65°C to +150°C
Soldering Information:	
SO Package	
(Vapor Phase in 60 sec)	215°C
SO Package (Infrared in 15 sec)	220°C

Power Dissipation	500 mW
Output Short Circuit Duration	10s
Junction Temperature	150°C
ESD Rating	
(C = +100 pF, R = 1.5 kΩ)	300V

## Operating Ratings (Note 1)

Supply Voltage	2.5V to 30V
Temperature Range	-40°C ≤ T <sub>J</sub> ≤ +85°C
Thermal Resistance (θ <sub>JA</sub> )	
SO Package	170°C/W

## DC Electrical Characteristics

Unless otherwise specified, all limits guaranteed for T<sub>J</sub> = 25°C. **Boldface** limits apply at the temperature extremes. V<sup>+</sup> = 2.7V, V<sup>-</sup> = 0V, 50Ω ≤ R<sub>L</sub> ≤ 50kΩ, and I<sub>L</sub> = 1.0 mA unless otherwise specified

Symbol	Parameter	Conditions	Typical	LM6511I	Units (Limits)
				Limit	
V <sub>OS</sub>	Offset Voltage	R <sub>S</sub> ≤ 50 kΩ (Note 3)	1.5	5	mV
				<b>8</b>	max
I <sub>B</sub>	Input Bias Current		38	130 <b>200</b>	nA max
I <sub>OS</sub>	Input Offset Current	R <sub>S</sub> ≤ 50 kΩ (Note 3)	1.5	20 <b>50</b>	max
I <sub>S</sub>	Positive Supply Current		2.7	3.5 <b>5</b>	mA max
	Negative Supply Current		1.5	2.0 <b>2.5</b>	
V <sub>SAT</sub>	Saturation Voltage	V <sub>IN</sub> ≤ 10 mV I <sub>SI</sub> = 8 mA	0.23	0.4 <b>0.4</b>	V max
A <sub>V</sub>	Large Signal Voltage Gain	ΔV <sub>OUT</sub> = 2V	40		V/mV
CMRR	Common Mode Rejection Ratio		72		dB
I <sub>STROBE</sub>	Strobe ON Current	(Note 5)	2.0	5.0	mA max
V <sub>IN</sub>	Input Voltage Range			0.50	V min
				V <sup>+</sup> - 1.25	V max
	Output Leakage Current	V <sub>IN</sub> ≥ 10 mV, V <sub>OUT</sub> = 35V, I <sub>STROBE</sub> = 3 mA	0.2		nA max

## AC Electrical Characteristics

Unless otherwise specified, all limits guaranteed for T<sub>J</sub> = 25°C. **Boldface** limits apply at the temperature extremes. V<sup>+</sup> = 2.7V, V<sup>-</sup> = 0V, 50Ω ≤ R<sub>L</sub> ≤ 50kΩ, and I<sub>L</sub> = 1.0 mA unless otherwise specified

Symbol	Parameter	Conditions	Typical	LM6511I	Units (Limits)
				Limit	
T <sub>R</sub>	Response Time	(Note 4)	180		ns

**Note 1:** Absolute Maximum Ratings indicate limits beyond which damage to the device may occur. Operating ratings indicate conditions the device is intended to be functional, but do not guarantee specific performance limits. For guaranteed specifications and test conditions, see the Electrical Characteristics. The guaranteed specifications apply only for the test conditions listed.

**Note 2:** The positive input voltage limit is 30V above the negative supply voltage. The negative input voltage limit is equal to the negative supply voltage or 30V below the positive supply voltage, whichever is less.

**Note 3:** The offset voltage and offset current limits are the maximum values required to drive the output within a volt of either supply with a 1 mA load. Therefore, these parameters define an error band and take into account the worst-case effects of voltage gain and input impedance.

**Note 4:** This specification is for a 100 mV input step with a 25 mV overdrive.

**Note 5:** This specification gives the range of current which must be drawn from the strobe pin to ensure the output is properly disabled. Do not short the strobe pin to ground; it should be current driven at 3 mA to 5 mA.

## Schematic Diagram

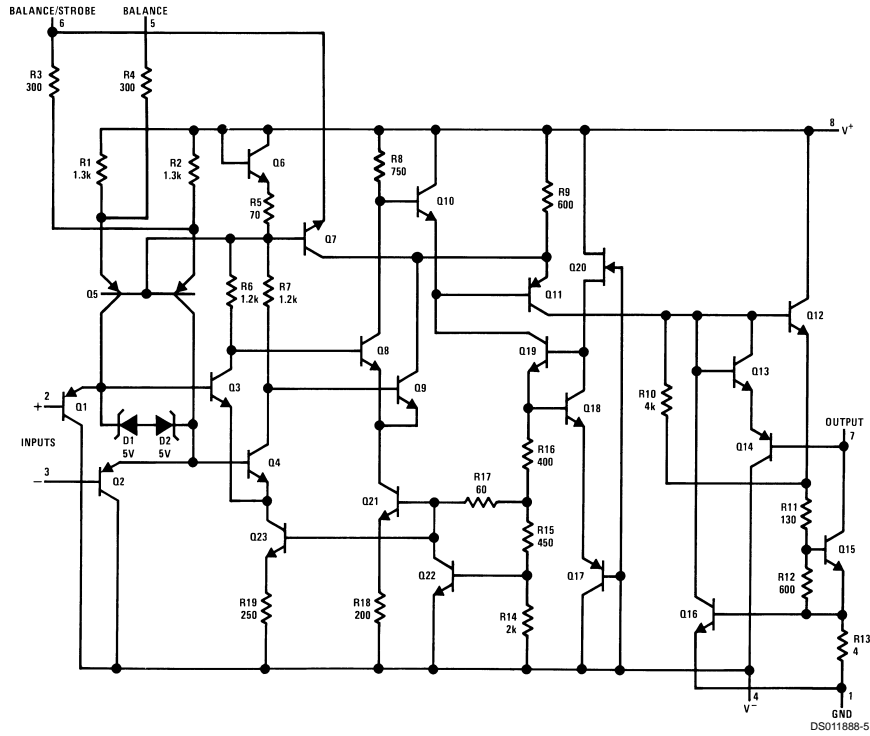

## LM6511 Typical Performance Characteristics $V_S = 3V$ unless otherwise noted

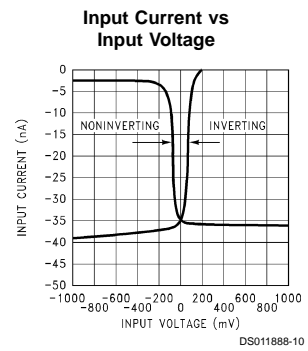
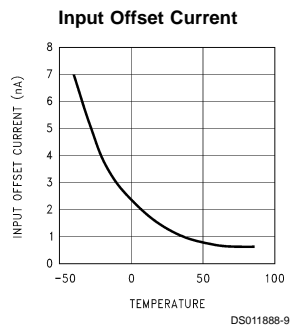
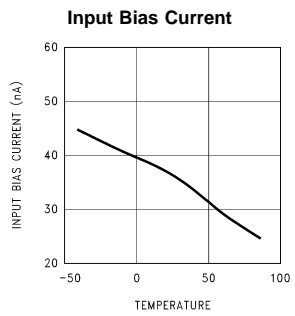

**LM6511 Typical Performance Characteristics**  $V_S = 3V$  unless otherwise noted (Continued)

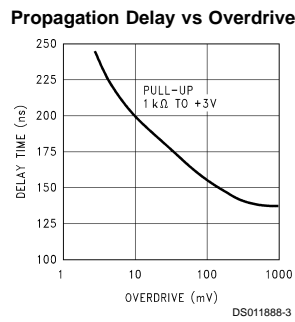
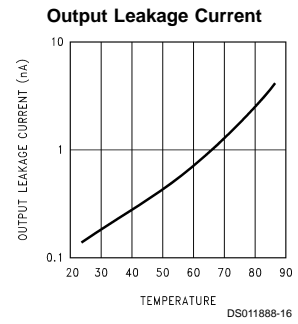
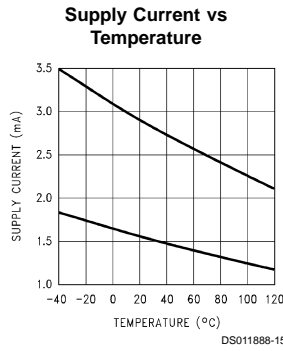
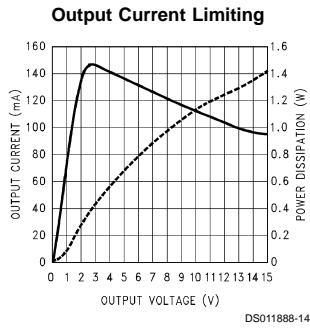
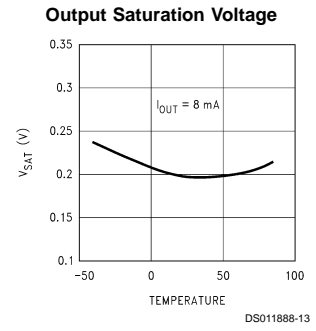
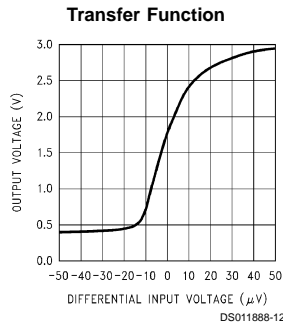
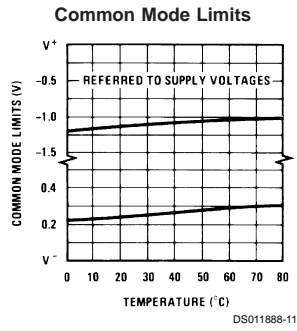

## Typical Application

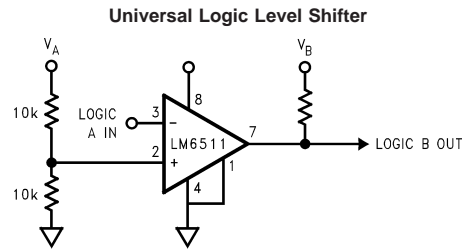

DS011888-4

**Notes:** Because of the very wide operating and output voltage range, the LM6511 may be used to shift logic levels from 3V to TTL or CMOS to the other way around. By biasing the input to  $\frac{1}{2}$  of the input logic supply ( $V_A$ ), this assures that this input remains within the input voltage range. The pull-up resistor should go to the output logic supply ( $V_B$ ).

**Physical Dimensions** inches (millimeters) unless otherwise noted

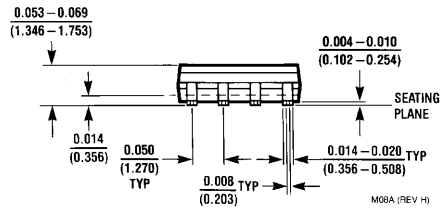
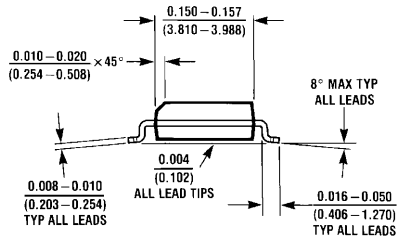
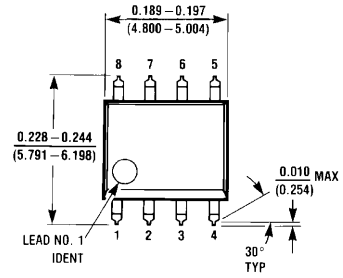

**8-Pin Small Outline Package (M)**  
**Order Number LM6511IM**  
**Package Number M08A**

**Physical Dimensions** inches (millimeters) unless otherwise noted (Continued)

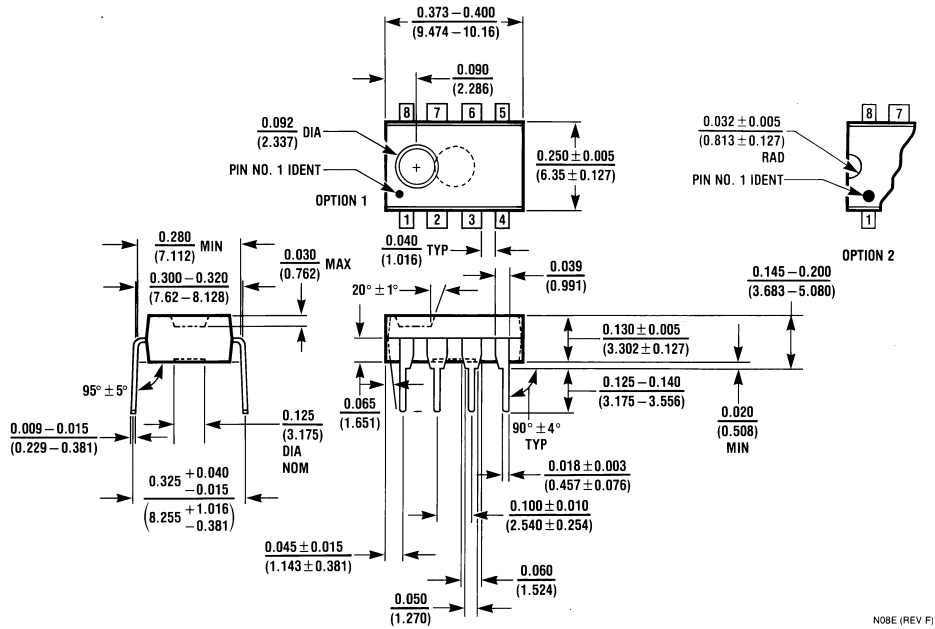

**8-Pin Molded Dual-In-Line Package (N)**  
**Order Number LM6511N**  
**Package Number N08E**

N08E (REV F)

**LIFE SUPPORT POLICY**

NATIONAL'S PRODUCTS ARE NOT AUTHORIZED FOR USE AS CRITICAL COMPONENTS IN LIFE SUPPORT DEVICES OR SYSTEMS WITHOUT THE EXPRESS WRITTEN APPROVAL OF THE PRESIDENT AND GENERAL COUNSEL OF NATIONAL SEMICONDUCTOR CORPORATION. As used herein:

1. Life support devices or systems are devices or systems which, (a) are intended for surgical implant into the body, or (b) support or sustain life, and whose failure to perform when properly used in accordance with instructions for use provided in the labeling, can be reasonably expected to result in a significant injury to the user.
2. A critical component is any component of a life support device or system whose failure to perform can be reasonably expected to cause the failure of the life support device or system, or to affect its safety or effectiveness.

**National Semiconductor Corporation**  
 Americas  
 Tel: 1-800-272-9959  
 Fax: 1-800-737-7018  
 Email: support@nsc.com

**National Semiconductor Europe**  
 Fax: +49 (0) 1 80-530 85 86  
 Email: europe.support@nsc.com  
 Deutsch Tel: +49 (0) 1 80-530 85 85  
 English Tel: +49 (0) 1 80-532 78 32  
 Français Tel: +49 (0) 1 80-532 93 58  
 Italiano Tel: +49 (0) 1 80-534 16 80

**National Semiconductor Asia Pacific Customer Response Group**  
 Tel: 65-2544466  
 Fax: 65-2504466  
 Email: sea.support@nsc.com

**National Semiconductor Japan Ltd.**  
 Tel: 81-3-5639-7560  
 Fax: 81-3-5639-7507

www.national.com