

LMC6482

CMOS Dual Rail-To-Rail Input and Output Operational Amplifier

General Description

The LMC6482 provides a common-mode range that extends to both supply rails. This rail-to-rail performance combined with excellent accuracy, due to a high CMRR, makes it unique among rail-to-rail input amplifiers.

It is ideal for systems, such as data acquisition, that require a large input signal range. The LMC6482 is also an excellent upgrade for circuits using limited common-mode range amplifiers such as the TLC272 and TLC277.

Maximum dynamic signal range is assured in low voltage and single supply systems by the LMC6482's rail-to-rail output swing. The LMC6482's rail-to-rail output swing is guaranteed for loads down to 600Ω.

Guaranteed low voltage characteristics and low power dissipation make the LMC6482 especially well-suited for battery-operated systems.

LMC6482 is also available in MSOP package which is almost half the size of a SO-8 device.

See the LMC6484 data sheet for a Quad CMOS operational amplifier with these same features.

Features

(Typical unless otherwise noted)

- Rail-to-Rail Input Common-Mode Voltage Range (Guaranteed Over Temperature)
- Rail-to-Rail Output Swing (within 20mV of supply rail, 100kΩ load)
- Guaranteed 3V, 5V and 15V Performance
- Excellent CMRR and PSRR: 82dB
- Ultra Low Input Current: 20fA
- High Voltage Gain ($R_L = 500k\Omega$): 130dB
- Specified for 2kΩ and 600Ω loads
- Available in MSOP Package

Applications

- Data Acquisition Systems
- Transducer Amplifiers
- Hand-held Analytic Instruments
- Medical Instrumentation
- Active Filter, Peak Detector, Sample and Hold, pH Meter, Current Source
- Improved Replacement for TLC272, TLC277

3V Single Supply Buffer Circuit

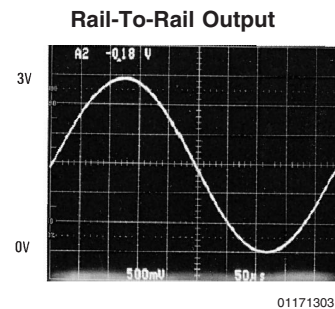
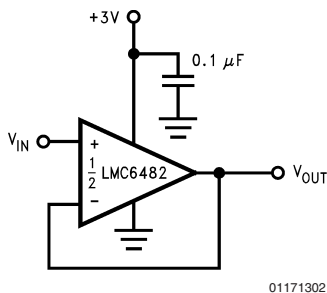
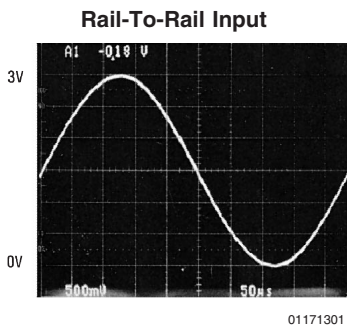

Connection Diagram

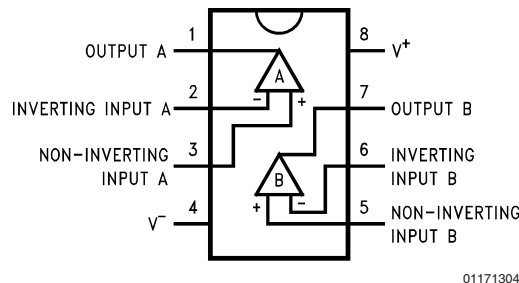

Absolute Maximum Ratings (Note 1)

If Military/Aerospace specified devices are required, please contact the National Semiconductor Sales Office/Distributors for availability and specifications.

ESD Tolerance (Note 2)	1.5kV
Differential Input Voltage	±Supply Voltage
Voltage at Input/Output Pin	(V ⁺) +0.3V, (V ⁻) -0.3V
Supply Voltage (V ⁺ - V ⁻)	16V
Current at Input Pin (Note 12)	±5mA
Current at Output Pin (Notes 3, 8)	±30mA
Current at Power Supply Pin	40mA
Lead Temperature (Soldering, 10 sec.)	260°C
Storage Temperature Range	-65°C to +150°C

Junction Temperature (Note 4)

150°C

Operating Ratings (Note 1)

Supply Voltage	3.0V ≤ V ⁺ ≤ 15.5V
Junction Temperature Range	
LMC6482AM	-55°C ≤ T _J ≤ +125°C
LMC6482AI, LMC6482I	-40°C ≤ T _J ≤ +85°C
Thermal Resistance (θ _{JA})	
N Package, 8-Pin Molded DIP	90°C/W
M Package, 8-Pin Surface Mount	155°C/W
MSOP package, 8-Pin Mini SO	194°C/W

DC Electrical Characteristics

Unless otherwise specified, all limits guaranteed for T_J = 25°C, V⁺ = 5V, V⁻ = 0V, V_{CM} = V_O = V⁺/2 and R_L > 1M. **Boldface** limits apply at the temperature extremes.

Symbol	Parameter	Conditions	Typ (Note 5)	LMC6482AI	LMC6482I	LMC6482M	Units	
				Limit (Note 6)	Limit (Note 6)	Limit (Note 6)		
V _{OS}	Input Offset Voltage		0.11	0.750 1.35	3.0 3.7	3.0 3.8	mV max	
TCV _{OS}	Input Offset Voltage Average Drift		1.0				μV/°C	
I _B	Input Current	(Note 13)	0.02	4.0	4.0	10.0	pA max	
I _{OS}	Input Offset Current	(Note 13)	0.01	2.0	2.0	5.0	pA max	
C _{IN}	Common-Mode Input Capacitance		3				pF	
R _{IN}	Input Resistance		>10				TeraΩ	
CMRR	Common Mode Rejection Ratio	0V ≤ V _{CM} ≤ 15.0V V ⁺ = 15V	82	70 67	65 62	65 60	dB min	
		0V ≤ V _{CM} ≤ 5.0V V ⁺ = 5V	82	70 67	65 62	65 60		
+PSRR	Positive Power Supply Rejection Ratio	5V ≤ V ⁺ ≤ 15V, V ⁻ = 0V V _O = 2.5V	82	70 67	65 62	65 60	dB min	
-PSRR	Negative Power Supply Rejection Ratio	-5V ≤ V ⁻ ≤ -15V, V ⁺ = 0V V _O = -2.5V	82	70 67	65 62	65 60	dB min	
V _{CM}	Input Common-Mode Voltage Range	V ⁺ = 5V and 15V For CMRR ≥ 50dB	V ⁻ - 0.3	- 0.25 0	- 0.25 0	- 0.25 0	V max	
			V ⁺ + 0.3V	V ⁺ + 0.25 V⁺	V ⁺ + 0.25 V⁺	V ⁺ + 0.25 V⁺	V min	
A _v	Large Signal Voltage Gain	R _L = 2kΩ (Notes 7, 13)	Sourcing	666	140 84	120 72	120 60	V/mV min
			Sinking	75	35 20	35 20	35 18	V/mV min
		R _L = 600Ω (Notes 7, 13)	Sourcing	300	80 48	50 30	50 25	V/mV min
			Sinking	35	20	15	15	V/mV

DC Electrical Characteristics (Continued)

Unless otherwise specified, all limits guaranteed for $T_J = 25^\circ\text{C}$, $V^+ = 5\text{V}$, $V^- = 0\text{V}$, $V_{CM} = V_O = V^+/2$ and $R_L > 1\text{M}$. **Boldface** limits apply at the temperature extremes.

Symbol	Parameter	Conditions	Typ (Note 5)	LMC6482AI Limit (Note 6)	LMC6482I Limit (Note 6)	LMC6482M Limit (Note 6)	Units
				13	10	8	min
V_O	Output Swing	$V^+ = 5\text{V}$ $R_L = 2\text{k}\Omega$ to $V^+/2$	4.9	4.8	4.8	4.8	V
			0.1	0.18	0.18	0.18	V
				4.7	4.7	4.7	max
		$V^+ = 5\text{V}$ $R_L = 600\Omega$ to $V^+/2$	4.7	4.5	4.5	4.5	V
			0.3	0.5	0.5	0.5	V
				4.24	4.24	4.24	max
	$V^+ = 15\text{V}$ $R_L = 2\text{k}\Omega$ to $V^+/2$	14.7	14.4	14.4	14.4	V	
		0.16	0.32	0.32	0.32	V	
			14.2	14.2	14.2	min	
			0.45	0.45	0.45	max	
$V^+ = 15\text{V}$ $R_L = 600\Omega$ to $V^+/2$	14.1	13.4	13.4	13.4	V		
	0.5	1.0	1.0	1.0	V		
		13.0	13.0	13.0	min		
		1.3	1.3	1.3	max		
I_{SC}	Output Short Circuit Current $V^+ = 5\text{V}$	Sourcing, $V_O = 0\text{V}$	20	16	16	16	mA
		Sinking, $V_O = 5\text{V}$	15	11	11	11	mA
I_{SC}	Output Short Circuit Current $V^+ = 15\text{V}$	Sourcing, $V_O = 0\text{V}$	30	28	28	28	mA
		Sinking, $V_O = 12\text{V}$ (Note 8)	30	30	30	30	mA
I_S	Supply Current	Both Amplifiers $V^+ = +5\text{V}$, $V_O = V^+/2$	1.0	1.4	1.4	1.4	mA
		Both Amplifiers $V^+ = 15\text{V}$, $V_O = V^+/2$	1.3	1.6	1.6	1.6	mA
				1.8	1.8	1.9	max
				1.9	1.9	2.0	max

AC Electrical Characteristics

Unless otherwise specified, all limits guaranteed for $T_J = 25^\circ\text{C}$, $V^+ = 5\text{V}$, $V^- = 0\text{V}$, $V_{CM} = V_O = V^+/2$, and $R_L > 1\text{M}$. **Boldface** limits apply at the temperature extremes.

Symbol	Parameter	Conditions	Typ (Note 5)	LMC6482AI Limit (Note 6)	LMC6482I Limit (Note 6)	LMC6482M Limit (Note 6)	Units
SR	Slew Rate	(Note 9)	1.3	1.0	0.9	0.9	V/ μs
				0.7	0.63	0.54	min
GBW	Gain-Bandwidth Product	$V^+ = 15\text{V}$	1.5				MHz
ϕ_m	Phase Margin		50				Deg
G_m	Gain Margin		15				dB
	Amp-to-Amp Isolation	(Note 10)	150				dB
e_n	Input-Referred Voltage Noise	$F = 1\text{kHz}$ $V_{cm} = 1\text{V}$	37				nV/ $\sqrt{\text{Hz}}$
i_n	Input-Referred Current Noise	$F = 1\text{kHz}$	0.03				pA/ $\sqrt{\text{Hz}}$

AC Electrical Characteristics (Continued)

Unless otherwise specified, all limits guaranteed for $T_J = 25^\circ\text{C}$, $V^+ = 5\text{V}$, $V^- = 0\text{V}$, $V_{\text{CM}} = V_O = V^+/2$, and $R_L > 1\text{M}$. **Boldface** limits apply at the temperature extremes.

Symbol	Parameter	Conditions	Typ (Note 5)	LMC6482AI Limit (Note 6)	LMC6482I Limit (Note 6)	LMC6482M Limit (Note 6)	Units
T.H.D.	Total Harmonic Distortion	$F = 10\text{kHz}$, $A_V = -2$ $R_L = 10\text{k}\Omega$, $V_O = 4.1 V_{\text{PP}}$	0.01				%
		$F = 10\text{kHz}$, $A_V = -2$ $R_L = 10\text{k}\Omega$, $V_O = 8.5 V_{\text{PP}}$ $V^+ = 10\text{V}$	0.01				%

DC Electrical Characteristics

Unless otherwise specified, all limits guaranteed for $T_J = 25^\circ\text{C}$, $V^+ = 3\text{V}$, $V^- = 0\text{V}$, $V_{\text{CM}} = V_O = V^+/2$ and $R_L > 1\text{M}$.

Symbol	Parameter	Conditions	Typ (Note 5)	LMC6482AI Limit (Note 6)	LMC6482I Limit (Note 6)	LMC6482M Limit (Note 6)	Units
V_{OS}	Input Offset Voltage		0.9	2.0 2.7	3.0 3.7	3.0 3.8	mV max
TCV_{OS}	Input Offset Voltage Average Drift		2.0				$\mu\text{V}/^\circ\text{C}$
I_{B}	Input Bias Current		0.02				pA
I_{OS}	Input Offset Current		0.01				pA
CMRR	Common Mode Rejection Ratio	$0\text{V} \leq V_{\text{CM}} \leq 3\text{V}$	74	64	60	60	dB min
PSRR	Power Supply Rejection Ratio	$3\text{V} \leq V^+ \leq 15\text{V}$, $V^- = 0\text{V}$	80	68	60	60	dB min
V_{CM}	Input Common-Mode Voltage Range	For CMRR $\geq 50\text{dB}$	$V^- - 0.25$	0	0	0	V max
			$V^+ + 0.25$	V^+	V^+	V^+	V min
V_O	Output Swing	$R_L = 2\text{k}\Omega$ to $V^+/2$	2.8				V
			0.2				V
		$R_L = 600\Omega$ to $V^+/2$	2.7	2.5	2.5	2.5	V min
			0.37	0.6	0.6	0.6	V max
I_{S}	Supply Current	Both Amplifiers	0.825	1.2 1.5	1.2 1.5	1.2 1.6	mA max

AC Electrical Characteristics

Unless otherwise specified, $V^+ = 3\text{V}$, $V^- = 0\text{V}$, $V_{\text{CM}} = V_O = V^+/2$, and $R_L > 1\text{M}$.

Symbol	Parameter	Conditions	Typ (Note 5)	LMC6482AI Limit (Note 6)	LMC6482I Limit (Note 6)	LMC6482M Limit (Note 6)	Units
SR	Slew Rate	(Note 11)	0.9				$\text{V}/\mu\text{s}$
GBW	Gain-Bandwidth Product		1.0				MHz
T.H.D.	Total Harmonic Distortion	$F = 10\text{kHz}$, $A_V = -2$ $R_L = 10\text{k}\Omega$, $V_O = 2 V_{\text{PP}}$	0.01				%

Note 1: Absolute Maximum Ratings indicate limits beyond which damage to the device may occur. Operating Ratings indicate conditions for which the device is intended to be functional, but specific performance is not guaranteed. For guaranteed specifications and the test conditions, see the Electrical Characteristics.

Note 2: Human body model, 1.5k Ω in series with 100pF. All pins rated per method 3015.6 of MIL-STD-883. This is a Class 1 device rating.

AC Electrical Characteristics (Continued)

Note 3: Applies to both single-supply and split-supply operation. Continuous short circuit operation at elevated ambient temperature can result in exceeding the maximum allowed junction temperature of 150°C. Output currents in excess of ±30mA over long term may adversely affect reliability.

Note 4: The maximum power dissipation is a function of $T_{J(max)}$, θ_{JA} , and T_A . The maximum allowable power dissipation at any ambient temperature is $P_D = (T_{J(max)} - T_A)/\theta_{JA}$. All numbers apply for packages soldered directly into a PC board.

Note 5: Typical Values represent the most likely parametric norm.

Note 6: All limits are guaranteed by testing or statistical analysis.

Note 7: $V^+ = 15V$, $V_{CM} = 7.5V$ and R_L connected to 7.5V. For Sourcing tests, $7.5V \leq V_O \leq 11.5V$. For Sinking tests, $3.5V \leq V_O \leq 7.5V$.

Note 8: Do not short circuit output to V^+ , when V^+ is greater than 13V or reliability will be adversely affected.

Note 9: $V^+ = 15V$. Connected as Voltage Follower with 10V step input. Number specified is the slower of either the positive or negative slew rates.

Note 10: Input referred, $V^+ = 15V$ and $R_L = 100\text{ k}\Omega$ connected to 7.5V. Each amp excited in turn with 1 kHz to produce $V_O = 12\text{ V}_{PP}$.

Note 11: Connected as voltage Follower with 2V step input. Number specified is the slower of either the positive or negative slew rates.

Note 12: Limiting input pin current is only necessary for input voltages that exceed absolute maximum input voltage ratings.

Note 13: Guaranteed limits are dictated by tester limitations and not device performance. Actual performance is reflected in the typical value.

Note 14: For guaranteed Military Temperature parameters see RETS6482X.

Typical Performance Characteristics

$V_S = +15V$, Single Supply, $T_A = 25^\circ\text{C}$ unless otherwise specified

Supply Current vs. Supply Voltage

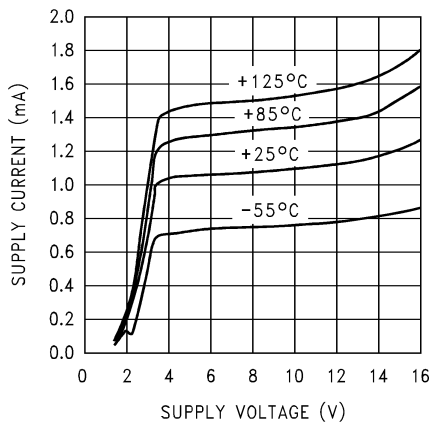

01171340

Input Current vs. Temperature

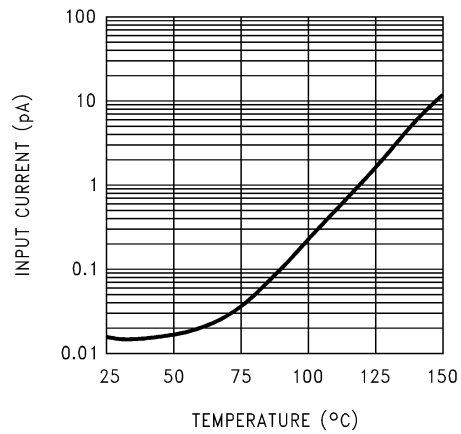

01171341

Sourcing Current vs. Output Voltage

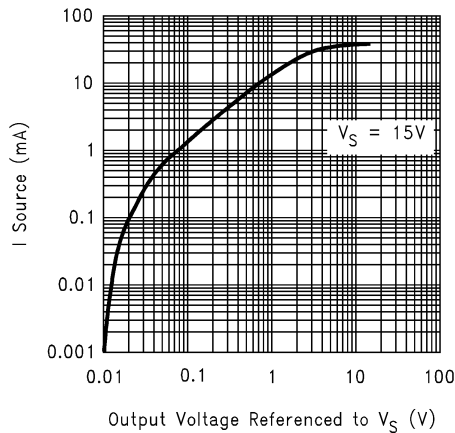

01171342

Sourcing Current vs. Output Voltage

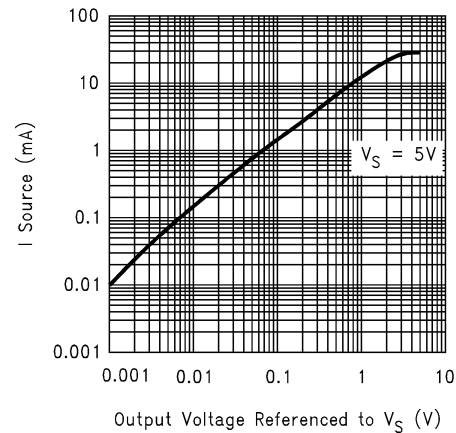

01171343

Typical Performance Characteristics $V_S = +15V$, Single Supply, $T_A = 25^\circ C$ unless otherwise specified (Continued)

Sourcing Current vs. Output Voltage

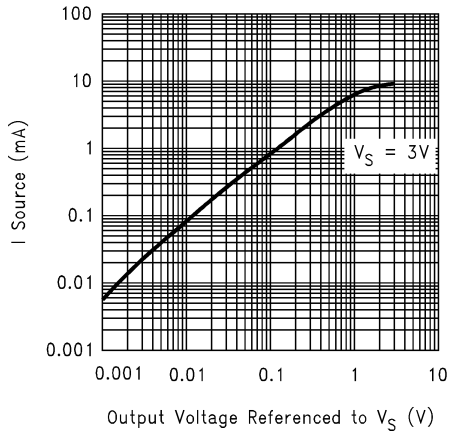

Sinking Current vs. Output Voltage

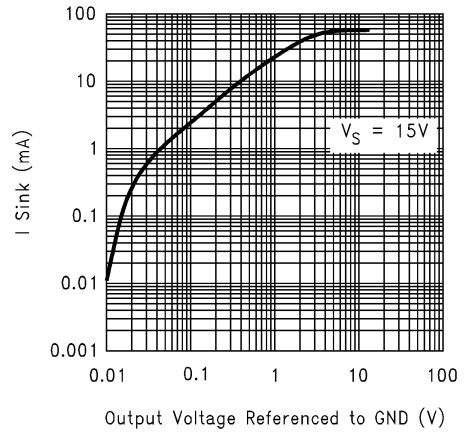

Sinking Current vs. Output Voltage

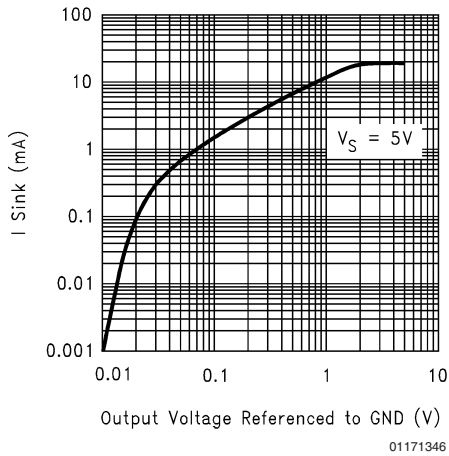

Sinking Current vs. Output Voltage

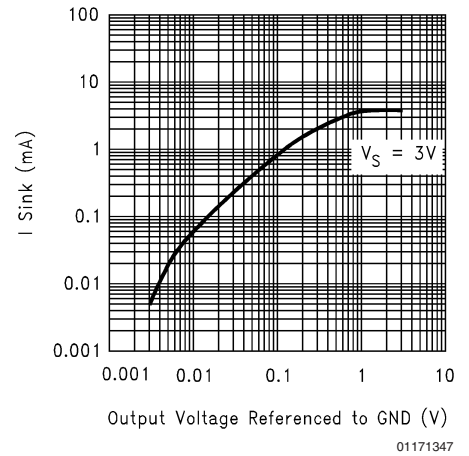

Output Voltage Swing vs. Supply Voltage

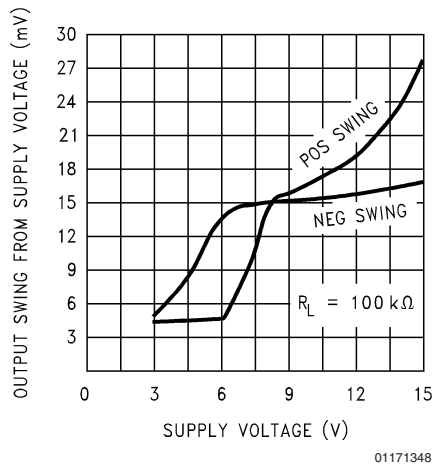

Input Voltage Noise vs. Frequency

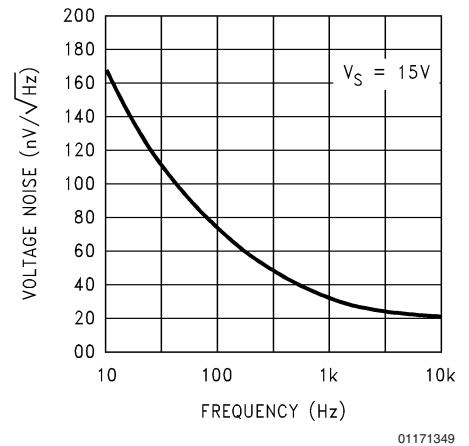

Typical Performance Characteristics $V_S = +15V$, Single Supply, $T_A = 25^\circ C$ unless otherwise specified (Continued)

Input Voltage Noise vs. Input Voltage

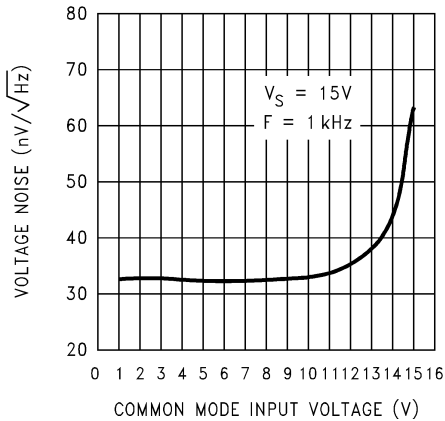

01171350

Input Voltage Noise vs. Input Voltage

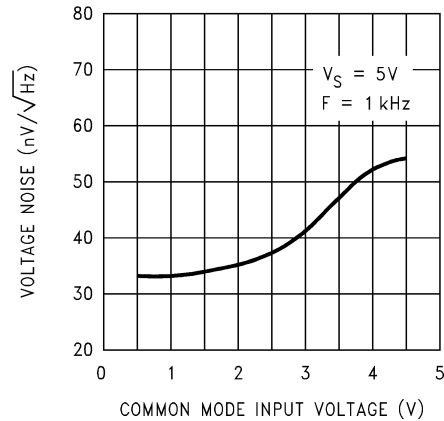

01171351

Input Voltage Noise vs. Input Voltage

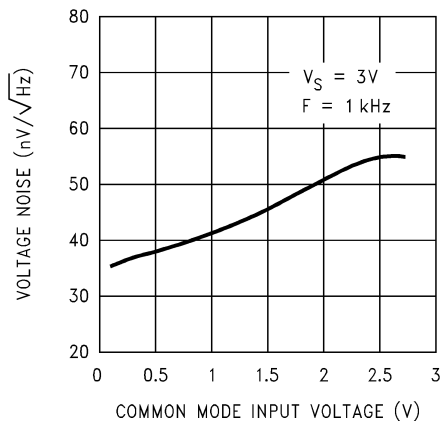

01171352

Crosstalk Rejection vs. Frequency

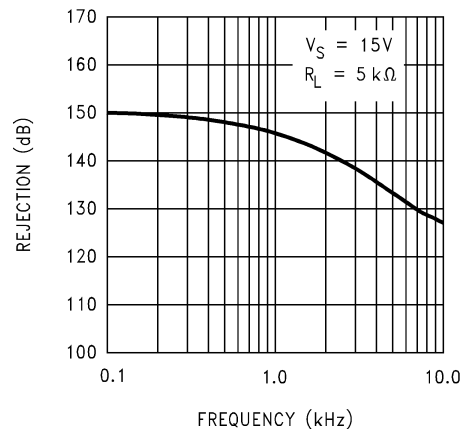

01171353

Crosstalk Rejection vs. Frequency

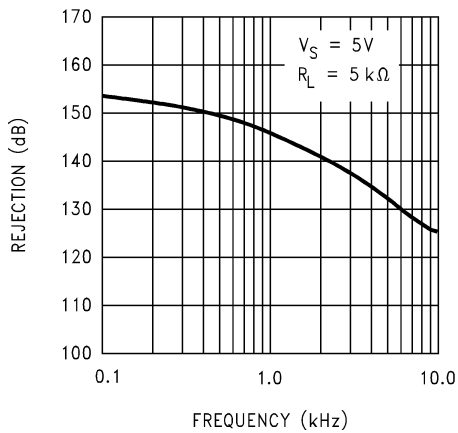

01171354

Positive PSRR vs. Frequency

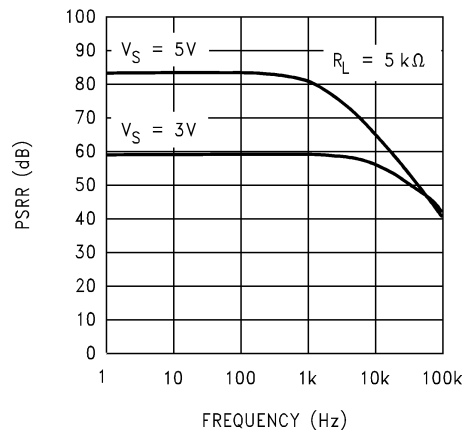

01171355

Typical Performance Characteristics $V_S = +15V$, Single Supply, $T_A = 25^\circ C$ unless otherwise specified (Continued)

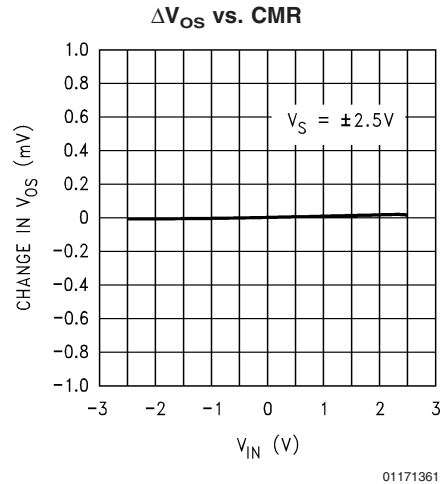
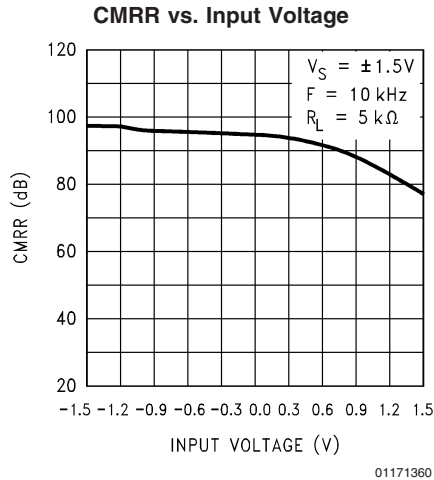
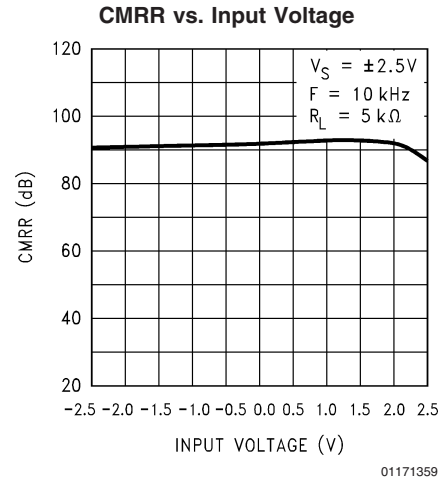
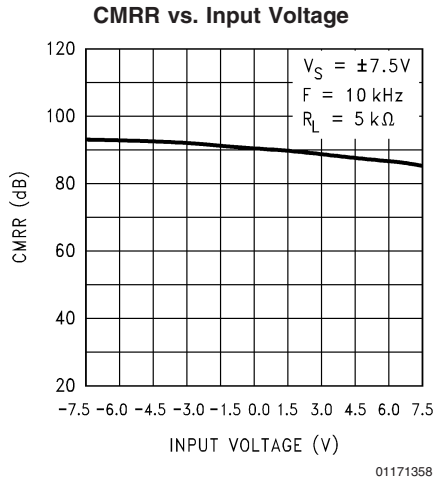
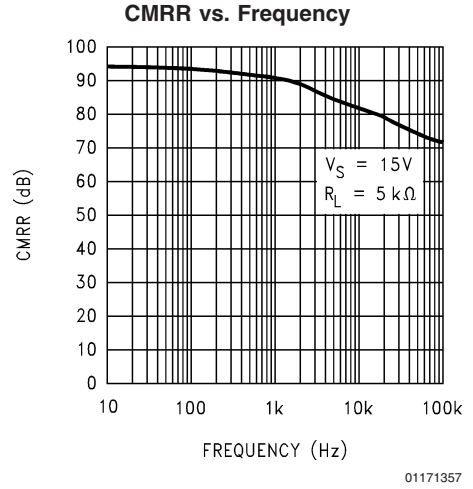
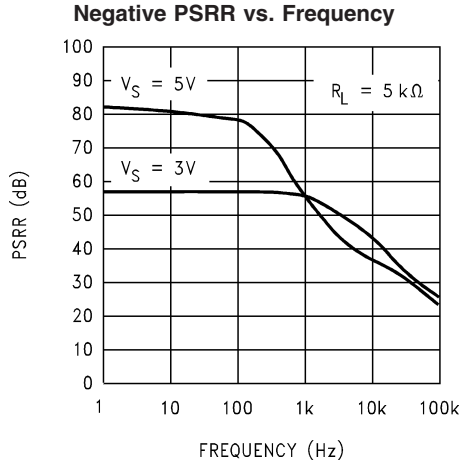

Typical Performance Characteristics $V_S = +15V$, Single Supply, $T_A = 25^\circ C$ unless otherwise specified (Continued)

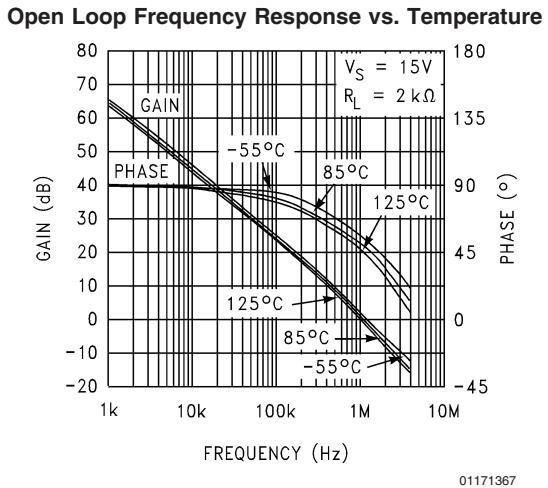
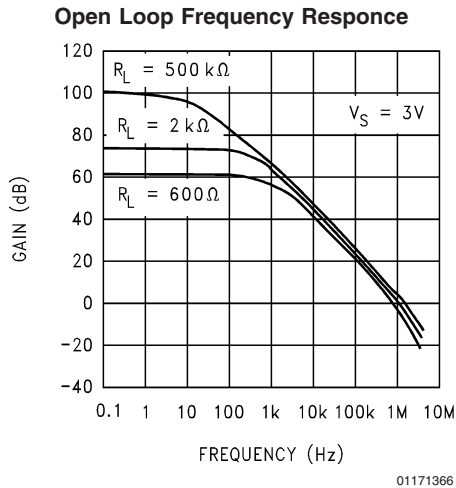
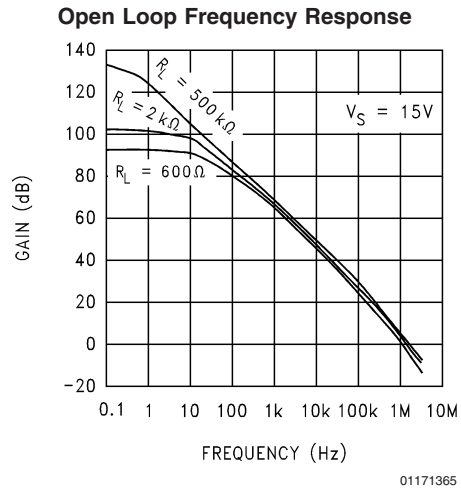
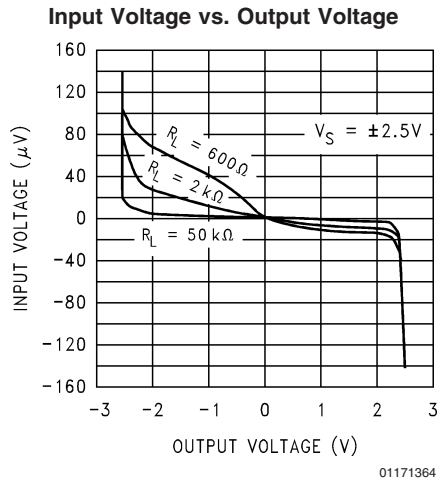
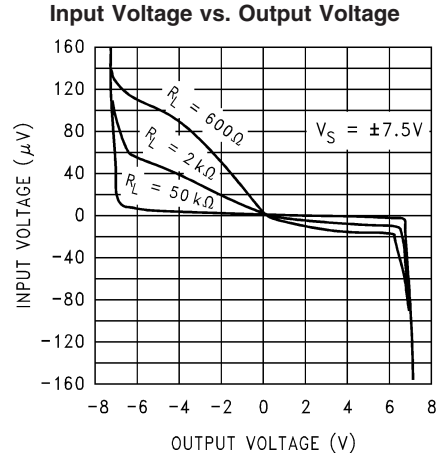
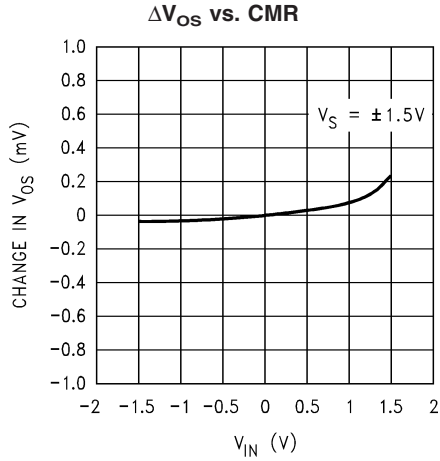

Typical Performance Characteristics $V_S = +15V$, Single Supply, $T_A = 25^\circ C$ unless otherwise specified (Continued)

Maximum Output Swing vs. Frequency

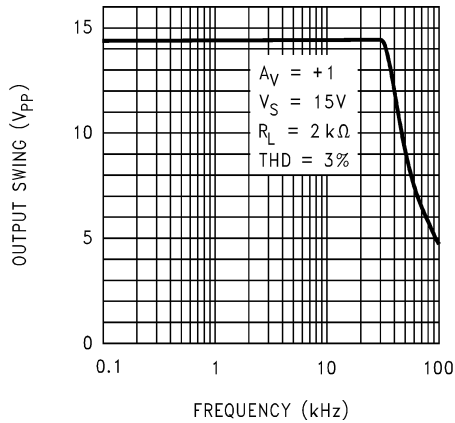

Gain and Phase vs. Capacitive Load

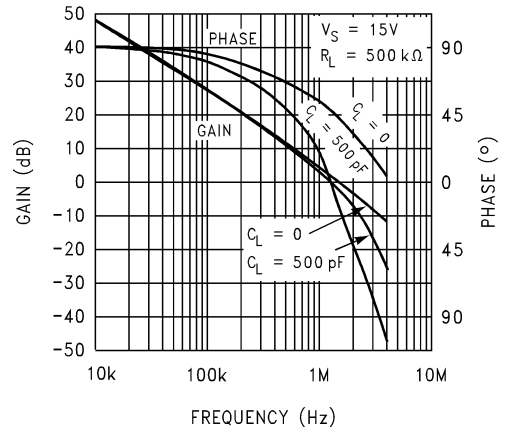

Gain and Phase vs. Capacitive Load

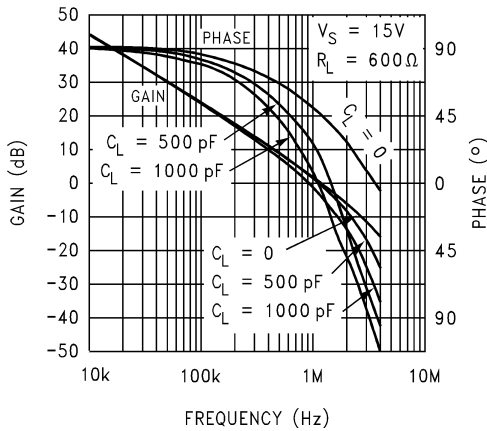

Open Loop Output Impedance vs. Frequency

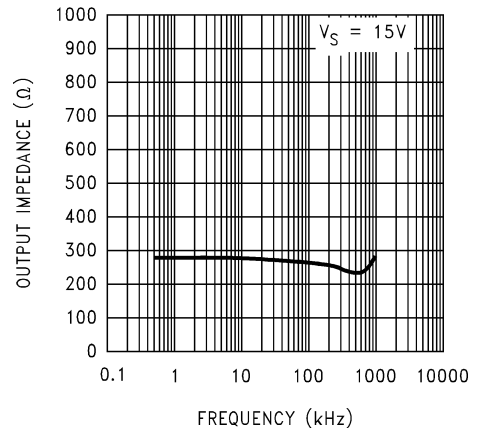

Open Loop Output Impedance vs. Frequency

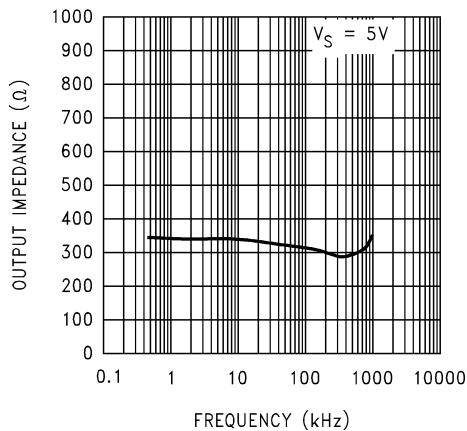

Slew Rate vs. Supply Voltage

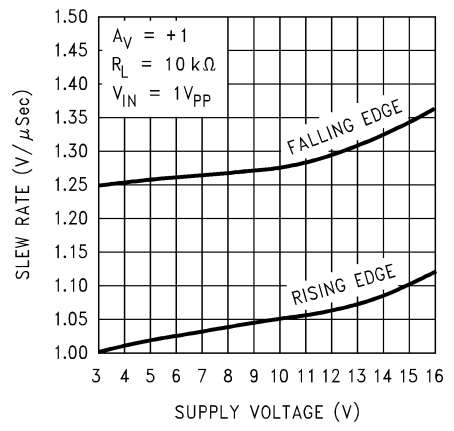

Typical Performance Characteristics $V_S = +15V$, Single Supply, $T_A = 25^\circ C$ unless otherwise specified (Continued)

Non-Inverting Large Signal Pulse Response

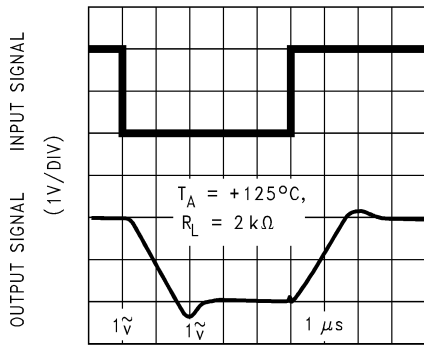
TIME (1 μs /DIV)

01171374

Non-Inverting Large Signal Pulse Response

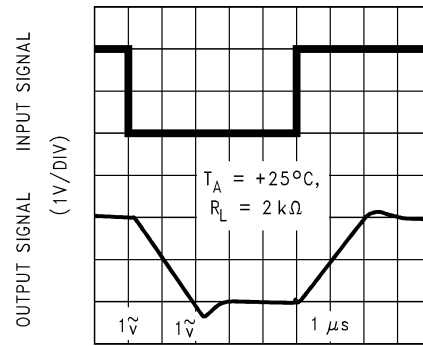
TIME (1 μs /DIV)

01171375

Non-Inverting Large Signal Pulse Response

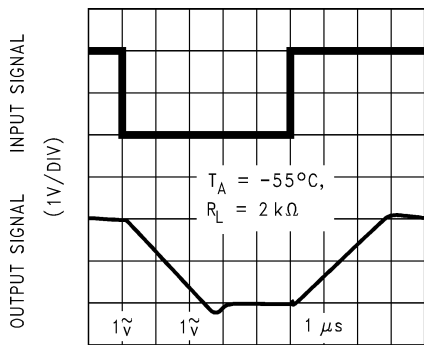
TIME (1 μs /DIV)

01171376

Non-Inverting Small Signal Pulse Response

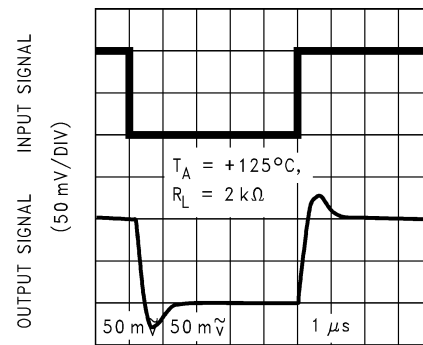
TIME (1 μs /DIV)

01171377

Non-Inverting Small Signal Pulse Response

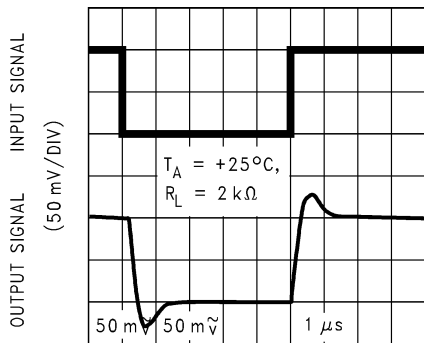
TIME (1 μs /DIV)

01171378

Non-Inverting Small Signal Pulse Response

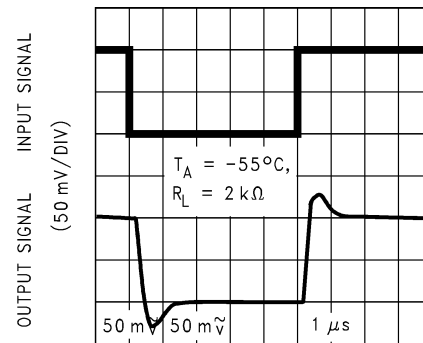
TIME (1 μs /DIV)

01171379

Typical Performance Characteristics $V_S = +15V$, Single Supply, $T_A = 25^\circ C$ unless otherwise specified (Continued)

Inverting Large Signal Pulse Response

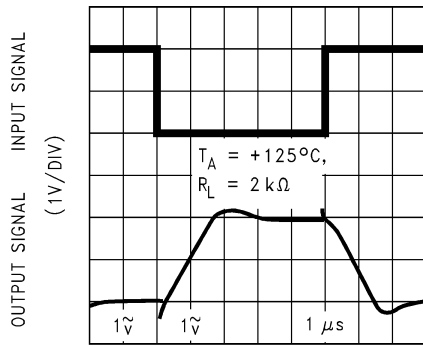

TIME (1 μs /DIV)

01171380

Inverting Large Signal Pulse Response

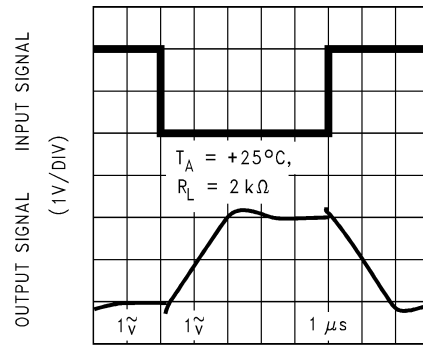

TIME (1 μs /DIV)

01171381

Inverting Large Signal Pulse Response

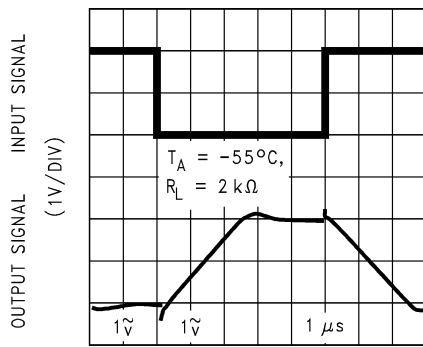

TIME (1 μs /DIV)

01171382

Inverting Small Signal Pulse Response

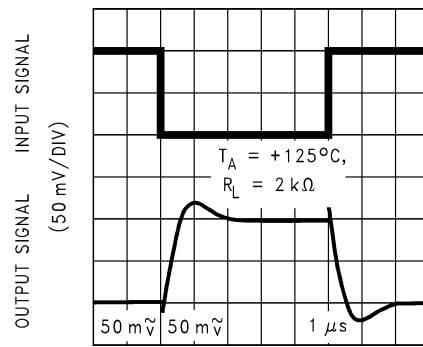

TIME (1 μs /DIV)

01171383

Inverting Small Signal Pulse Response

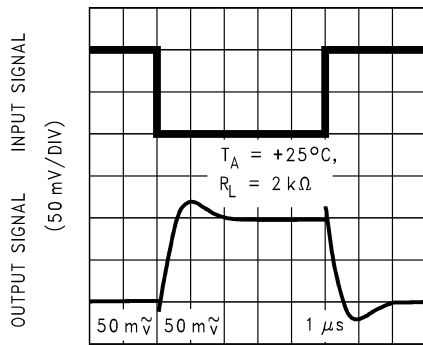

TIME (1 μs /DIV)

01171384

Inverting Small Signal Pulse Response

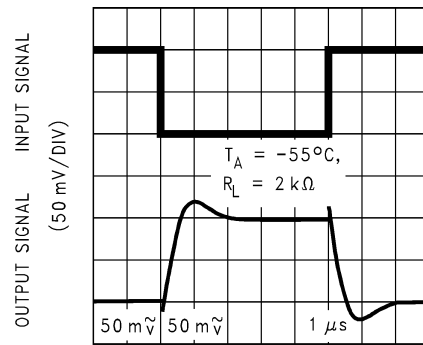

TIME (1 μs /DIV)

01171385

Typical Performance Characteristics $V_S = +15V$, Single Supply, $T_A = 25^\circ C$ unless otherwise specified (Continued)

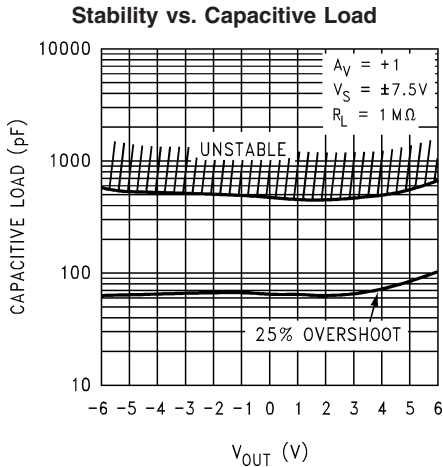

01171386

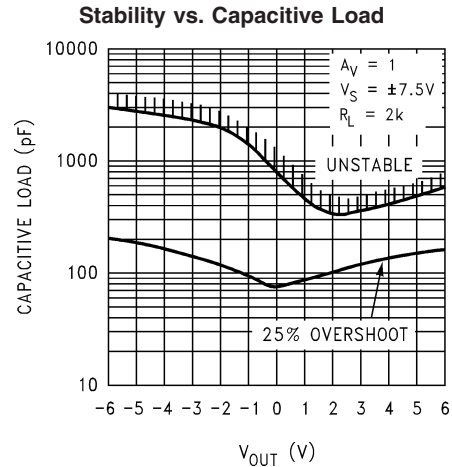

01171387

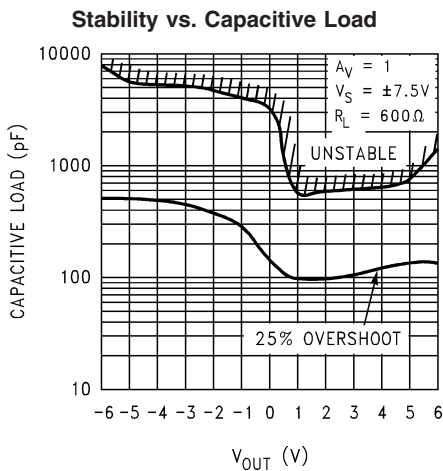

01171388

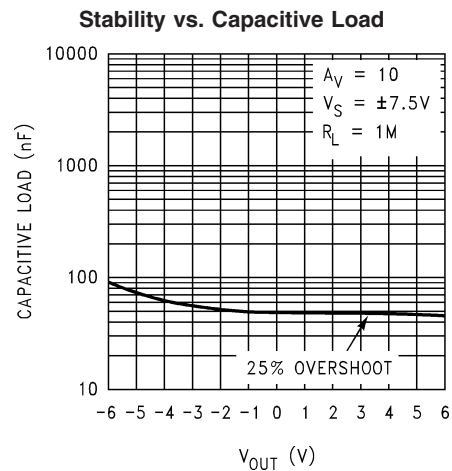

01171389

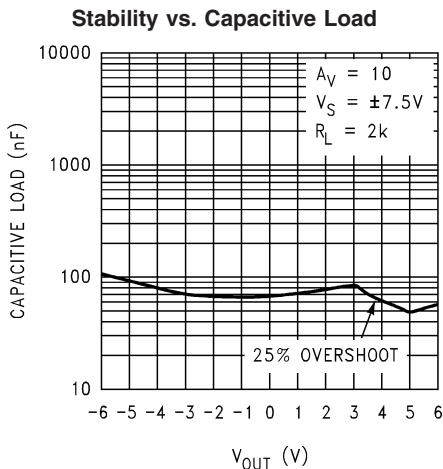

01171390

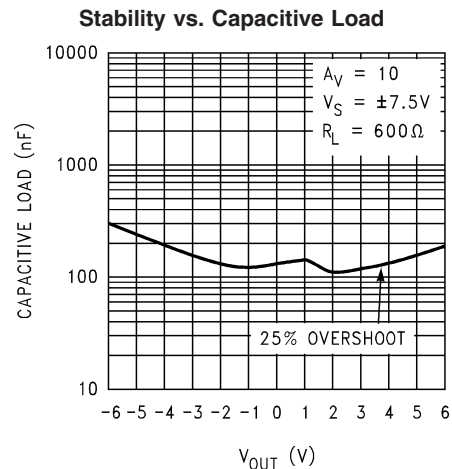

01171391

Application Information

1.0 AMPLIFIER TOPOLOGY

The LMC6482 incorporates specially designed wide-compliance range current mirrors and the body effect to extend input common mode range to each supply rail. Complementary paralleled differential input stages, like the type used in other CMOS and bipolar rail-to-rail input amplifiers, were not used because of their inherent accuracy problems due to CMRR, cross-over distortion, and open-loop gain variation.

The LMC6482's input stage design is complemented by an output stage capable of rail-to-rail output swing even when driving a large load. Rail-to-rail output swing is obtained by taking the output directly from the internal integrator instead of an output buffer stage.

2.0 INPUT COMMON-MODE VOLTAGE RANGE

Unlike Bi-FET amplifier designs, the LMC6482 does not exhibit phase inversion when an input voltage exceeds the negative supply voltage. *Figure 1* shows an input voltage exceeding both supplies with no resulting phase inversion on the output.

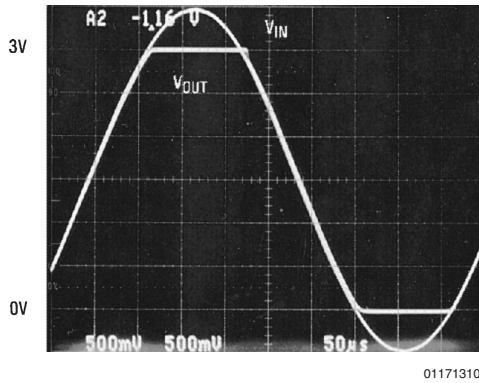

FIGURE 1. An Input Voltage Signal Exceeds the LMC6482 Power Supply Voltages with No Output Phase Inversion

The absolute maximum input voltage is 300mV beyond either supply rail at room temperature. Voltages greatly exceeding this absolute maximum rating, as in *Figure 2*, can cause excessive current to flow in or out of the input pins possibly affecting reliability.

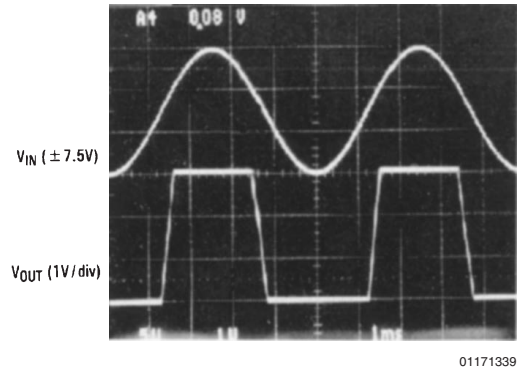

FIGURE 2. A ±7.5V Input Signal Greatly Exceeds the 3V Supply in *Figure 3* Causing No Phase Inversion Due to R_I

Applications that exceed this rating must externally limit the maximum input current to $\pm 5\text{mA}$ with an input resistor (R_I) as shown in *Figure 3*.

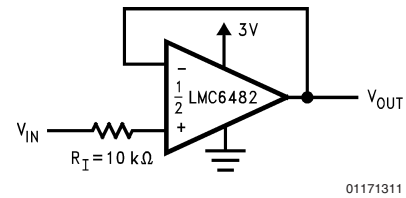

FIGURE 3. R_I Input Current Protection for Voltages Exceeding the Supply Voltages

3.0 RAIL-TO-RAIL OUTPUT

The approximated output resistance of the LMC6482 is 180Ω sourcing and 130Ω sinking at $V_S = 3\text{V}$ and 110Ω sourcing and 80Ω sinking at $V_S = 5\text{V}$. Using the calculated output resistance, maximum output voltage swing can be estimated as a function of load.

4.0 CAPACITIVE LOAD TOLERANCE

The LMC6482 can typically directly drive a 100pF load with $V_S = 15\text{V}$ at unity gain without oscillating. The unity gain follower is the most sensitive configuration. Direct capacitive loading reduces the phase margin of op-amps. The combination of the op-amp's output impedance and the capacitive load induces phase lag. This results in either an underdamped pulse response or oscillation.

Capacitive load compensation can be accomplished using resistive isolation as shown in *Figure 4*. This simple technique is useful for isolating the capacitive inputs of multiplexers and A/D converters.

Application Information (Continued)

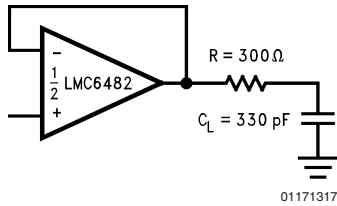
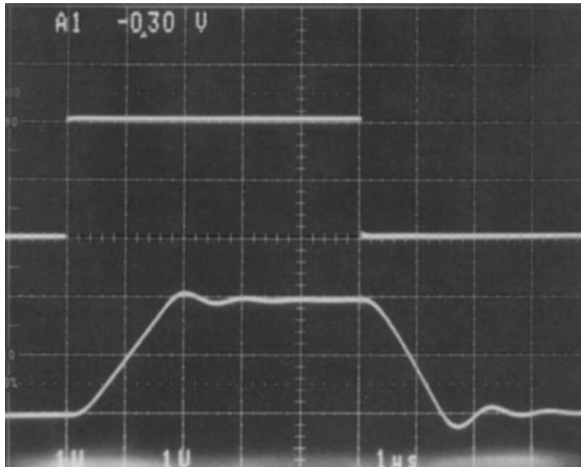

FIGURE 4. Resistive Isolation of a 330pF Capacitive Load



01171318

FIGURE 5. Pulse Response of the LMC6482 Circuit in Figure 4

Improved frequency response is achieved by indirectly driving capacitive loads, as shown in Figure 6.

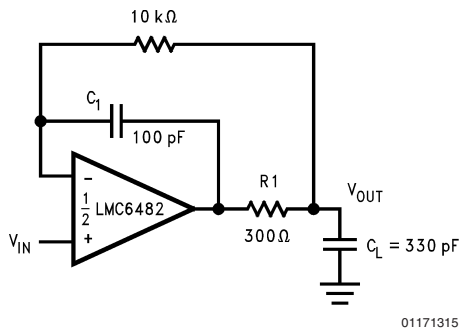

01171315

FIGURE 6. LMC6482 Noninverting Amplifier, Compensated to Handle a 330pF Capacitive Load

R1 and C1 serve to counteract the loss of phase margin by feeding forward the high frequency component of the output signal back to the amplifiers inverting input, thereby preserving phase margin in the overall feedback loop. The values of R1 and C1 are experimentally determined for the desired pulse response. The resulting pulse response can be seen in Figure 7.

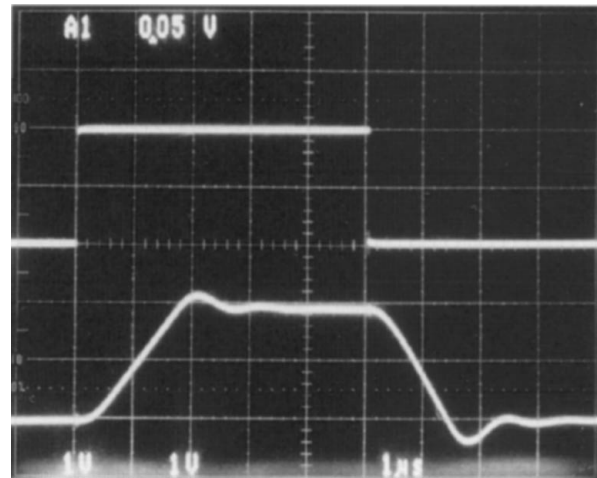

01171316

FIGURE 7. Pulse Response of LMC6482 Circuit in Figure 6

5.0 COMPENSATING FOR INPUT CAPACITANCE

It is quite common to use large values of feedback resistance with amplifiers that have ultra-low input current, like the LMC6482. Large feedback resistors can react with small values of input capacitance due to transducers, photodiodes, and circuits board parasitics to reduce phase margins.

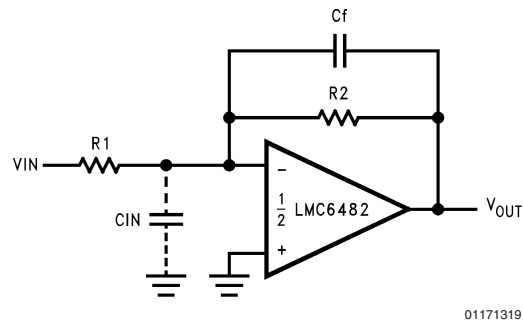

01171319

FIGURE 8. Canceling the Effect of Input Capacitance

The effect of input capacitance can be compensated for by adding a feedback capacitor. The feedback capacitor (as in Figure 8), Cf, is first estimated by:

$$\frac{1}{2\pi R_1 C_{IN}} \geq \frac{1}{2\pi R_2 C_f}$$

or

$$R_1 C_{IN} \leq R_2 C_f$$

which typically provides significant overcompensation.

Printed circuit board stray capacitance may be larger or smaller than that of a bread-board, so the actual optimum value for Cf may be different. The values of Cf should be checked on the actual circuit. (Refer to the LMC660 quad CMOS amplifier data sheet for a more detailed discussion.)

Application Information (Continued)

6.0 PRINTED-CIRCUIT-BOARD LAYOUT FOR HIGH-IMPEDANCE WORK

It is generally recognized that any circuit which must operate with less than 1000pA of leakage current requires special layout of the PC board. When one wishes to take advantage of the ultra-low input current of the LMC6482, typically less than 20fA, it is essential to have an excellent layout. Fortunately, the techniques of obtaining low leakages are quite simple. First, the user must not ignore the surface leakage of the PC board, even though it may sometimes appear acceptably low, because under conditions of high humidity or dust or contamination, the surface leakage will be appreciable.

To minimize the effect of any surface leakage, lay out a ring of foil completely surrounding the LMC6482's inputs and the terminals of capacitors, diodes, conductors, resistors, relay terminals, etc. connected to the op-amp's inputs, as in *Figure 9*. To have a significant effect, guard rings should be placed on both the top and bottom of the PC board. This PC foil must then be connected to a voltage which is at the same voltage as the amplifier inputs, since no leakage current can flow between two points at the same potential. For example, a PC board trace-to-pad resistance of $10^{12}\Omega$, which is normally considered a very large resistance, could leak 5pA if the trace were a 5V bus adjacent to the pad of the input. This would cause a 250 times degradation from the LMC6482's actual performance. However, if a guard ring is held within 5 mV of the inputs, then even a resistance of $10^{11}\Omega$ would cause only 0.05pA of leakage current. See *Figure 10* for typical connections of guard rings for standard op-amp configurations.

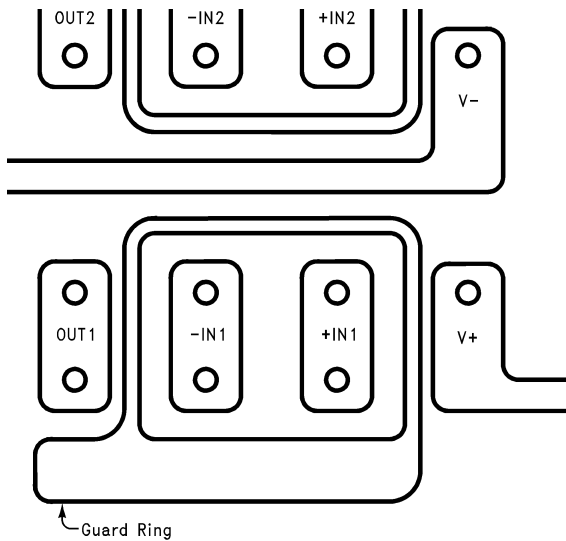

01171320

FIGURE 9. Example of Guard Ring in P.C. Board Layout

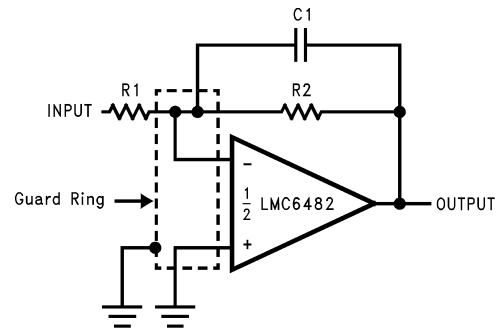

01171321

Inverting Amplifier

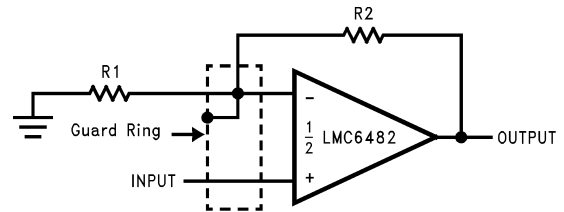

01171322

Non-Inverting Amplifier

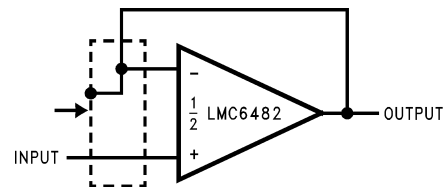

01171323

Follower

FIGURE 10. Typical Connections of Guard Rings

The designer should be aware that when it is inappropriate to lay out a PC board for the sake of just a few circuits, there is another technique which is even better than a guard ring on a PC board: Don't insert the amplifier's input pin into the board at all, but bend it up in the air and use only air as an insulator. Air is an excellent insulator. In this case you may have to forego some of the advantages of PC board construction, but the advantages are sometimes well worth the effort of using point-to-point up-in-the-air wiring. See *Figure 11*.

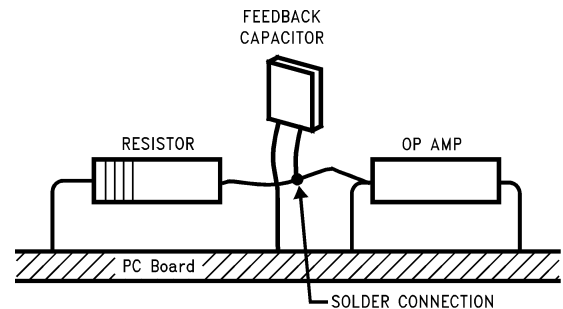

01171324

(Input pins are lifted out of PC board and soldered directly to components. All other pins connected to PC board.)

FIGURE 11. Air Wiring

Application Information (Continued)

7.0 OFFSET VOLTAGE ADJUSTMENT

Offset voltage adjustment circuits are illustrated in *Figure 12* *Figure 13*. Large value resistances and potentiometers are used to reduce power consumption while providing typically $\pm 2.5\text{mV}$ of adjustment range, referred to the input, for both configurations with $V_S = \pm 5\text{V}$.

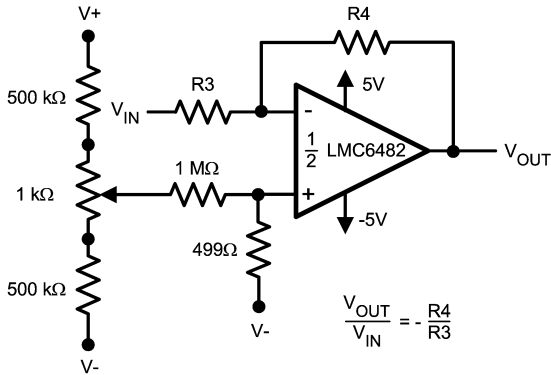

01171325

**FIGURE 12. Inverting Configuration
Offset Voltage Adjustment**

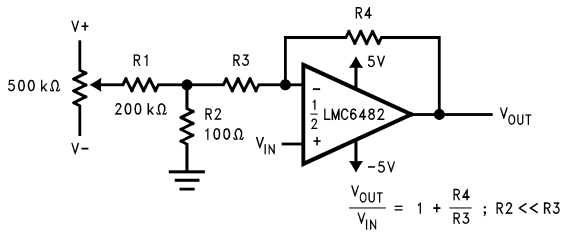

01171326

**FIGURE 13. Non-Inverting Configuration
Offset Voltage Adjustment**

8.0 UPGRADING APPLICATIONS

The LMC6484 quads and LMC6482 duals have industry standard pin outs to retrofit existing applications. System performance can be greatly increased by the LMC6482's features. The key benefit of designing in the LMC6482 is increased linear signal range. Most op-amps have limited input common mode ranges. Signals that exceed this range generate a non-linear output response that persists long after the input signal returns to the common mode range.

Linear signal range is vital in applications such as filters where signal peaking can exceed input common mode ranges resulting in output phase inversion or severe distortion.

9.0 DATA ACQUISITION SYSTEMS

Low power, single supply data acquisition system solutions are provided by buffering the ADC12038 with the LMC6482 (*Figure 14*). Capable of using the full supply range, the LMC6482 does not require input signals to be scaled down to meet limited common mode voltage ranges. The LMC4282 CMRR of 82dB maintains integral linearity of a 12-bit data acquisition system to ± 0.325 LSB. Other rail-to-rail input amplifiers with only 50dB of CMRR will degrade the accuracy of the data acquisition system to only 8 bits.

Application Information (Continued)

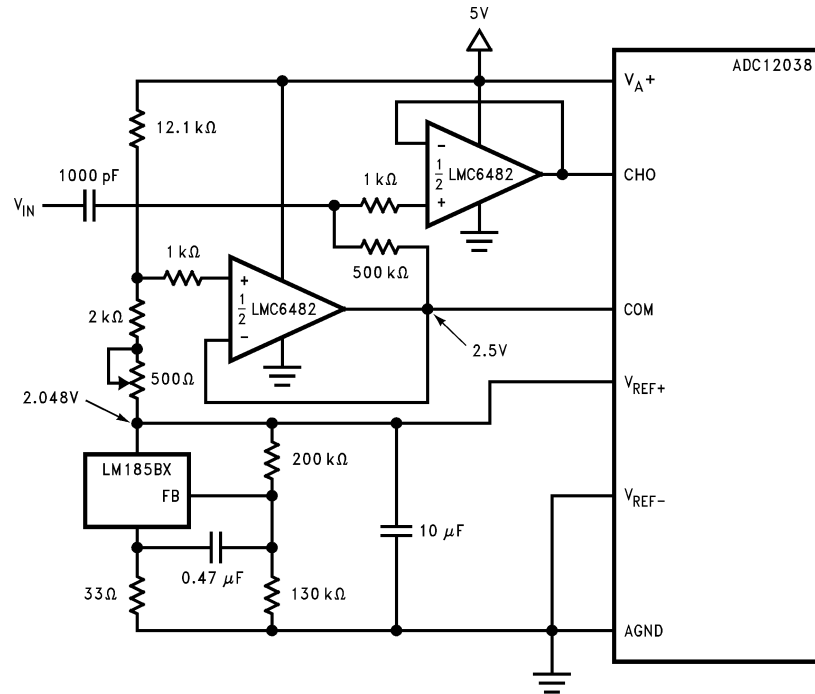

01171328

FIGURE 14. Operating from the same Supply Voltage, the LMC6482 buffers the ADC12038 maintaining excellent accuracy

10.0 INSTRUMENTATION CIRCUITS

The LMC6482 has the high input impedance, large common-mode range and high CMRR needed for designing instrumentation circuits. Instrumentation circuits designed with the LMC6482 can reject a larger range of common-mode signals than most in-amps. This makes instrumentation circuits designed with the LMC6482 an excellent choice of noisy or industrial environments. Other applications that benefit from

these features include analytic medical instruments, magnetic field detectors, gas detectors, and silicon-based transducers.

A small valued potentiometer is used in series with R_g to set the differential gain of the 3 op-amp instrumentation circuit in *Figure 15*. This combination is used instead of one large valued potentiometer to increase gain trim accuracy and reduce error due to vibration.

Application Information (Continued)

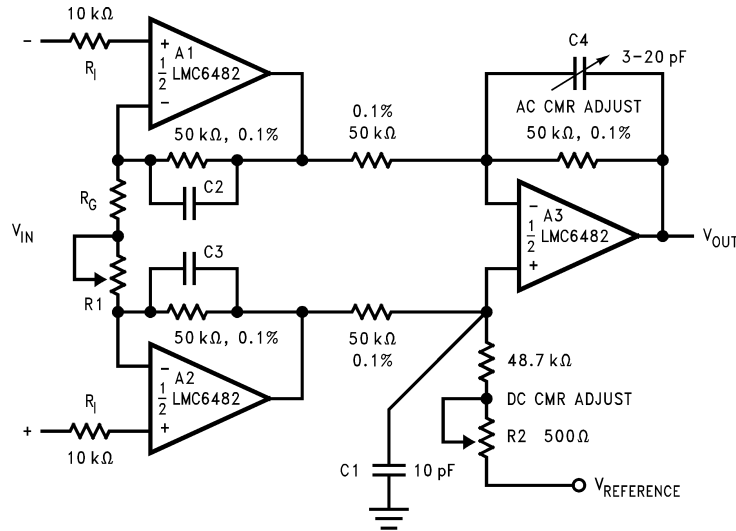

01171329

FIGURE 15. Low Power 3 Op-Amp Instrumentation Amplifier

A 2 op-amp instrumentation amplifier designed for a gain of 100 is shown in *Figure 16*. Low sensitivity trimming is made for offset voltage, CMRR and gain. Low cost and low power consumption are the main advantages of this two op-amp circuit.

Higher frequency and larger common-mode range applications are best facilitated by a three op-amp instrumentation amplifier.

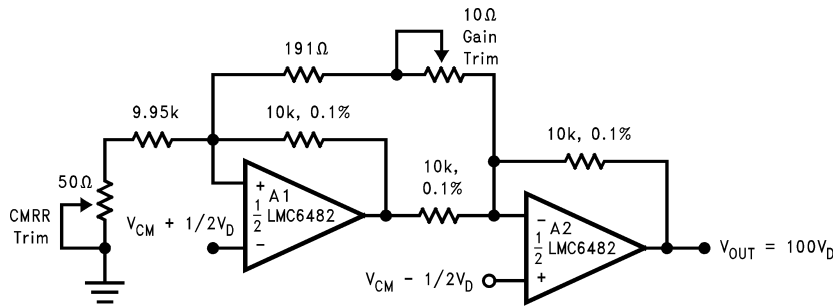

01171330

FIGURE 16. Low-Power Two-Op-Amp Instrumentation Amplifier

11.0 SPICE MACROMODEL

A spice macromodel is available for the LMC6482. This model includes accurate simulation of:

- Input common-mode voltage range
- Frequency and transient response
- GBW dependence on loading conditions
- Quiescent and dynamic supply current
- Output swing dependence on loading conditions

and many more characteristics as listed on the macromodel disk.

Contact your local National Semiconductor sales office to obtain an operational amplifier spice model library disk.

Typical Single-Supply Applications

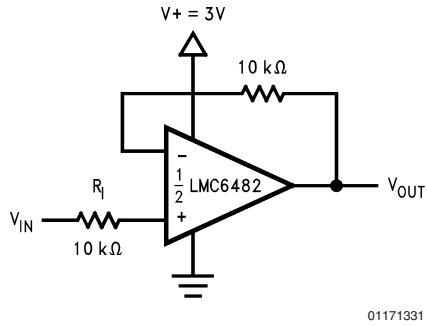

FIGURE 17. Half-Wave Rectifier with Input Current Protection (R_I)

01171331

The circuit in *Figure 17* uses a single supply to half wave rectify a sinusoid centered about ground. R_I limits current into the amplifier caused by the input voltage exceeding the supply voltage. Full wave rectification is provided by the circuit in *Figure 19*.

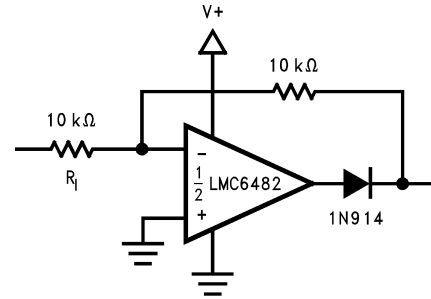
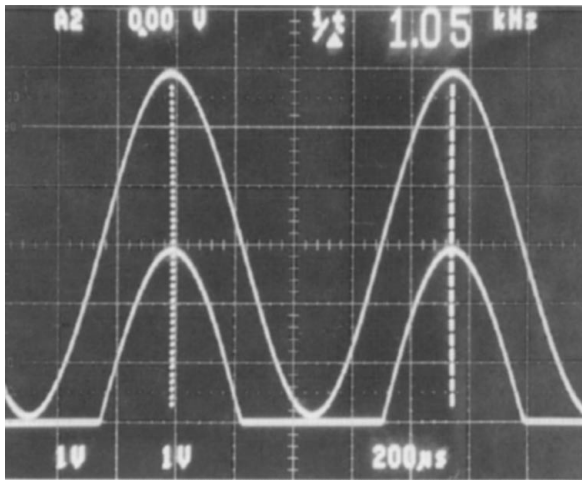

FIGURE 19. Full Wave Rectifier with Input Current Protection (R_I)

01171333



01171332

FIGURE 18. Half-Wave Rectifier Waveform

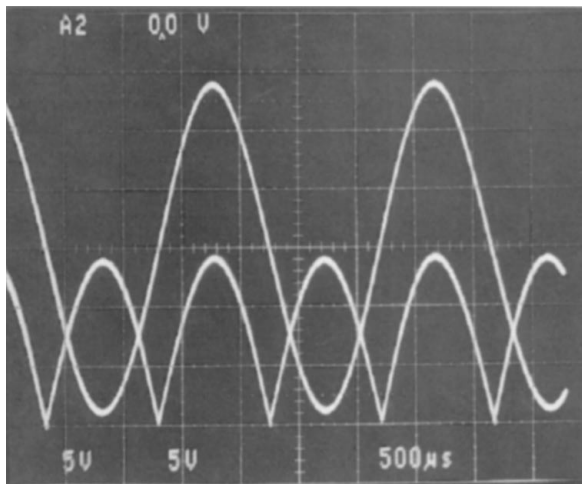

01171334

FIGURE 20. Full Wave Rectifier Waveform

Typical Single-Supply Applications

(Continued)

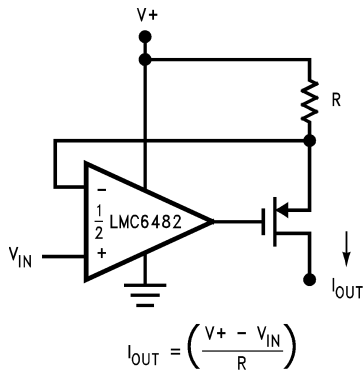

$$I_{OUT} = \left(\frac{V+ - V_{IN}}{R} \right)$$

01171335

FIGURE 21. Large Compliance Range Current Source

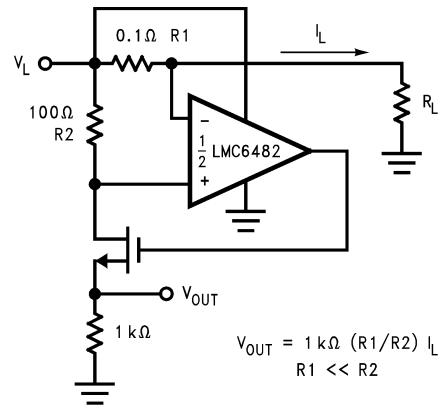

$$V_{OUT} = 1 \text{ k}\Omega \left(\frac{R1}{R2} \right) I_L$$

$$R1 \ll R2$$

01171336

FIGURE 22. Positive Supply Current Sense

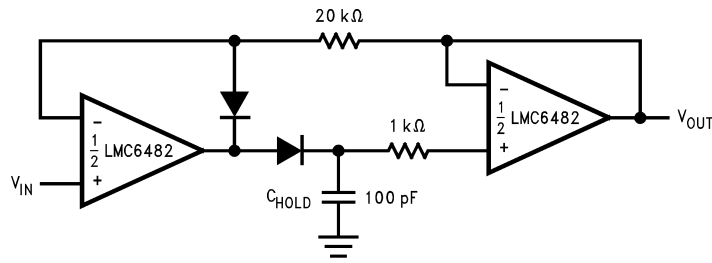

01171337

FIGURE 23. Low Voltage Peak Detector with Rail-to-Rail Peak Capture Range

In *Figure 23* dielectric absorption and leakage is minimized by using a polystyrene or polyethylene hold capacitor. The droop rate is primarily determined by the value of C_H and

diode leakage current. The ultra-low input current of the LMC6482 has a negligible effect on droop.

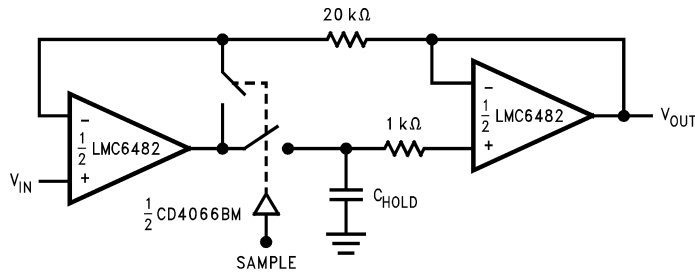

01171338

FIGURE 24. Rail-to-Rail Sample and Hold

The LMC6482's high CMRR (82dB) allows excellent accuracy throughout the circuit's rail-to-rail dynamic capture range.

Typical Single-Supply Applications (Continued)

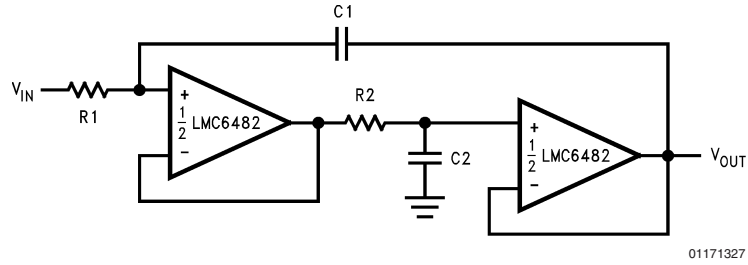

01171327

$$R1 = R2, C1 = C2; f = \frac{1}{2\pi R1 C1}; DF = \frac{1}{2} \sqrt{\frac{C2}{C1}} \sqrt{\frac{R2}{R1}}$$

FIGURE 25. Rail-to-Rail Single Supply Low Pass Filter

The low pass filter circuit in *Figure 25* can be used as an anti-aliasing filter with the same voltage supply as the A/D converter.

Filter designs can also take advantage of the LMC6482 ultra-low input current. The ultra-low input current yields

negligible offset error even when large value resistors are used. This in turn allows the use of smaller valued capacitors which take less board space and cost less.

Ordering Information

Package	Temperature Range		NSC Drawing	Transport Media	Package Marking
	Military -55°C to +125°C	Industrial -40°C to +85°C			
8-Pin Molded DIP		LMC6482AIN, LMC6482IN	N08E	Rail	LMC6482MN, LMC6482AIN, LMC6482IN
8-pin Small Outline		LMC6482AIM, LMC6482AIMX LMC6482IM, LMC6482IMX	M08A	Rail Tape and Reel	LMC6482AIM, LMC6482IM
8-pin Ceramic DIP	LMC6482AMJ/883		J08A	Rail	LMC6482AMJ/883Q5962-9453401MPA
8-pin Mini SO		LMC6482IMM LMC6482IMMX	MUA08A	Rail Tape and Reel	A10

Physical Dimensions inches (millimeters) unless otherwise noted

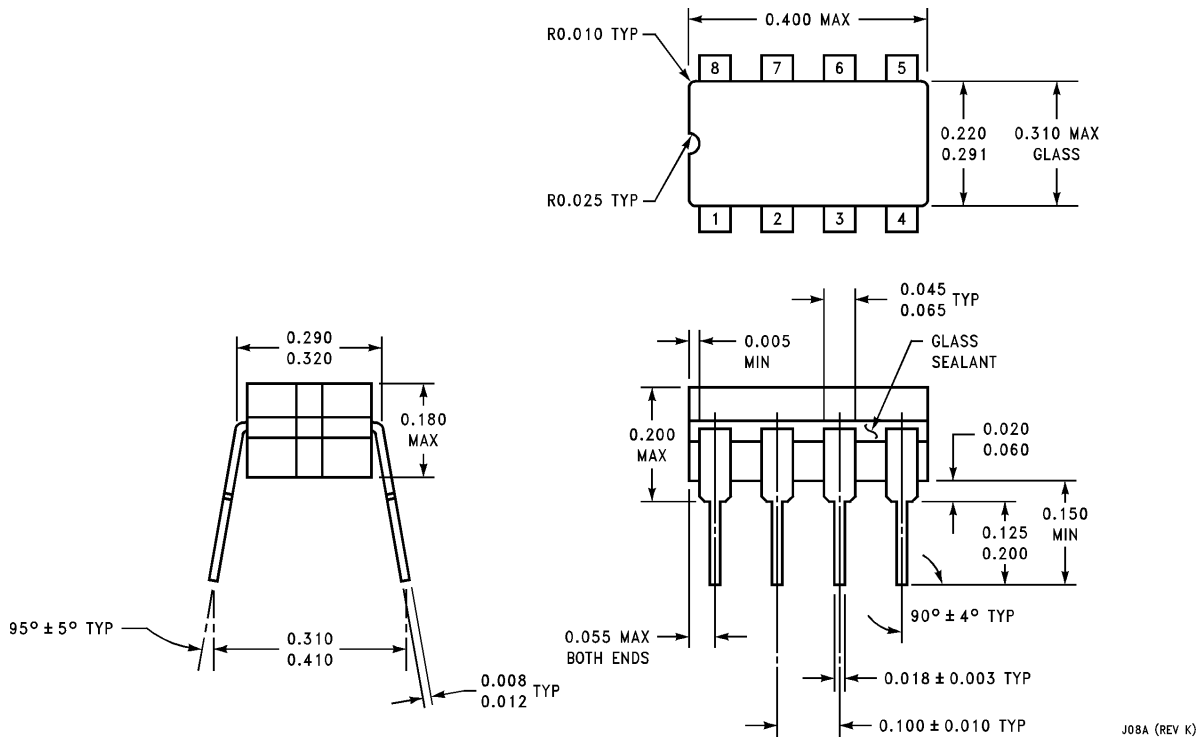

8-Pin Ceramic Dual-In-Line Package
Order Number LMC6482AMJ/883
NS Package Number J08A

J08A (REV K)

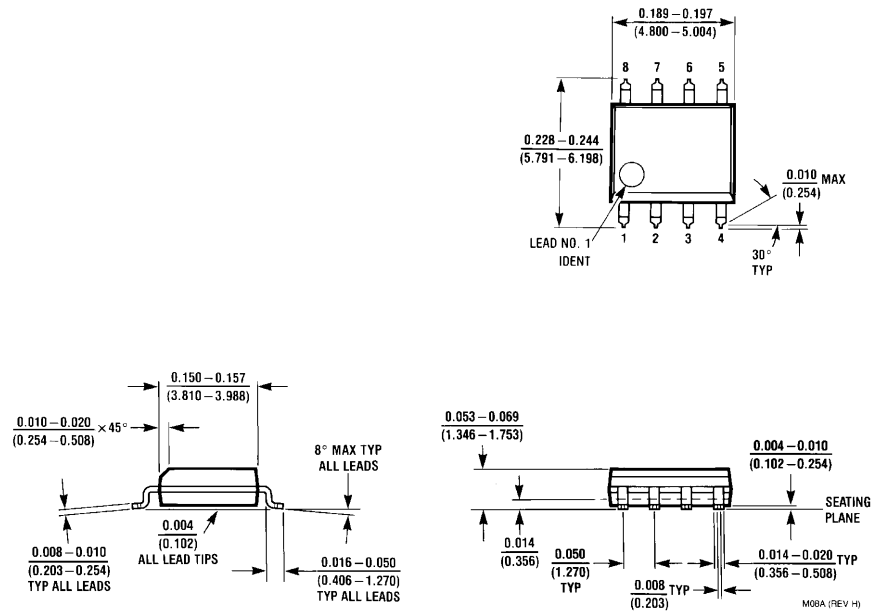

8-Pin Small Outline Package
Order Package Number LMC6482AIM, LMC6482AIMX, LMC6482IM or LMC6482IMX
NS Package Number M08A

M08A (REV H)

Physical Dimensions inches (millimeters) unless otherwise noted (Continued)

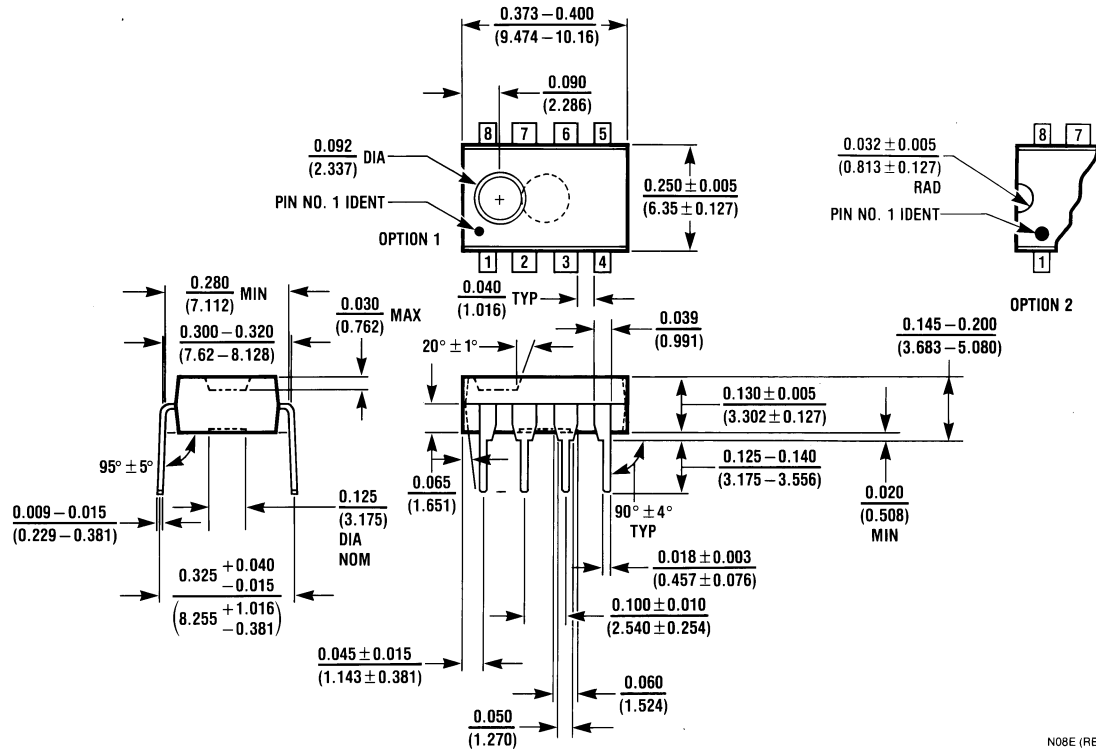

8-Pin Molded Dual-In-Line Package
Order Package Number LMC6482AIN, LMC6482IN
NS Package Number N08E

N08E (REV F)

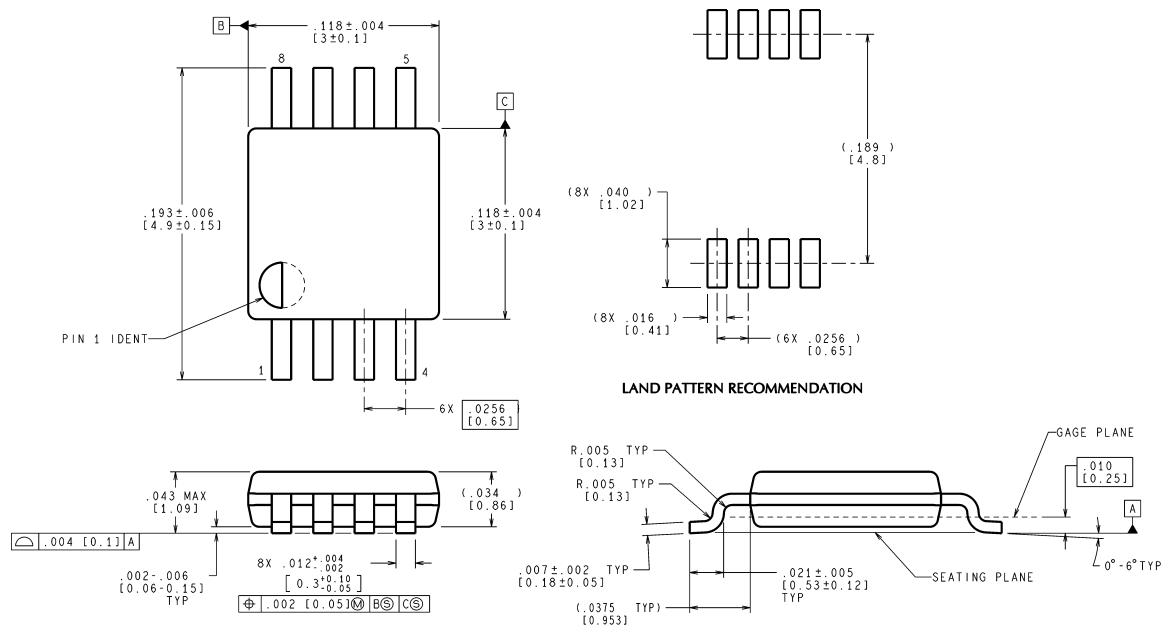

8-Lead Mini Small Outline Molded Package, JEDEC
Order Number LMC6482IMM, or LMC6482IMMX
NS Package Number MUA08A

MUA08A (Rev E)

Notes

National does not assume any responsibility for use of any circuitry described, no circuit patent licenses are implied and National reserves the right at any time without notice to change said circuitry and specifications.

For the most current product information visit us at www.national.com.

LIFE SUPPORT POLICY

NATIONAL'S PRODUCTS ARE NOT AUTHORIZED FOR USE AS CRITICAL COMPONENTS IN LIFE SUPPORT DEVICES OR SYSTEMS WITHOUT THE EXPRESS WRITTEN APPROVAL OF THE PRESIDENT AND GENERAL COUNSEL OF NATIONAL SEMICONDUCTOR CORPORATION. As used herein:

1. Life support devices or systems are devices or systems which, (a) are intended for surgical implant into the body, or (b) support or sustain life, and whose failure to perform when properly used in accordance with instructions for use provided in the labeling, can be reasonably expected to result in a significant injury to the user.
2. A critical component is any component of a life support device or system whose failure to perform can be reasonably expected to cause the failure of the life support device or system, or to affect its safety or effectiveness.

BANNED SUBSTANCE COMPLIANCE

National Semiconductor certifies that the products and packing materials meet the provisions of the Customer Products Stewardship Specification (CSP-9-111C2) and the Banned Substances and Materials of Interest Specification (CSP-9-111S2) and contain no "Banned Substances" as defined in CSP-9-111S2.



National Semiconductor
Americas Customer
Support Center
Email: new.feedback@nsc.com
Tel: 1-800-272-9959

National Semiconductor
Europe Customer Support Center
Fax: +49 (0) 180-530 85 86
Email: europe.support@nsc.com
Deutsch Tel: +49 (0) 69 9508 6208
English Tel: +44 (0) 870 24 0 2171
Français Tel: +33 (0) 1 41 91 8790

National Semiconductor
Asia Pacific Customer
Support Center
Email: ap.support@nsc.com

National Semiconductor
Japan Customer Support Center
Fax: 81-3-5639-7507
Email: jpn.feedback@nsc.com
Tel: 81-3-5639-7560