



**PRELIMINARY**  
October 2004

# LMP2011 Single/ LMP2012 Dual/ LMP2014 Quad High Precision, Rail-to-Rail Output Operational Amplifier

## General Description

The LMP201X is a new precision amplifier family that offers unprecedented accuracy and stability at an affordable price and is offered in miniature packages. This device utilizes patented techniques to measure and continually correct the input offset error voltage. The result is an amplifier which is ultra stable over time and temperature. It has excellent CMRR and PSRR ratings, and does not exhibit the familiar 1/f voltage and current noise increase that plagues traditional amplifiers. The combination of the LMP201X characteristics makes it a good choice for transducer amplifiers, high gain configurations, ADC buffer amplifiers, DAC I-V conversion, and any other 2.7V-5V application requiring precision and long term stability.

Other useful benefits of the LMP201X are rail-to-rail output, a low supply current of 930  $\mu$ A, and wide gain-bandwidth product of 3 MHz. These extremely versatile features found in the LMP201X provide high performance and ease of use.

## Features

(For  $V_S = 5V$ , Typical unless otherwise noted)

- Low guaranteed  $V_{OS}$  over temperature 60  $\mu$ V
- Low noise with no 1/f 35nV/ $\sqrt{Hz}$
- High CMRR 130 dB
- High PSRR 120 dB
- High  $A_{VOL}$  130 dB
- Wide gain-bandwidth product 3MHz
- High slew rate 4V/ $\mu$ s
- Low supply current 930 $\mu$ A
- Rail-to-rail output 30mV
- No external capacitors required

## Applications

- Precision instrumentation amplifiers
- Thermocouple amplifiers
- Strain gauge bridge amplifier

## Connection Diagrams

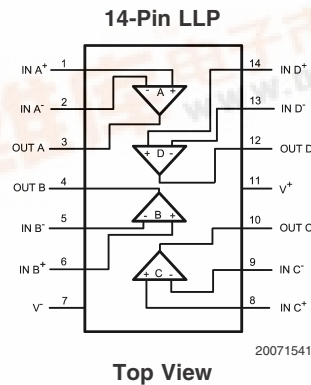
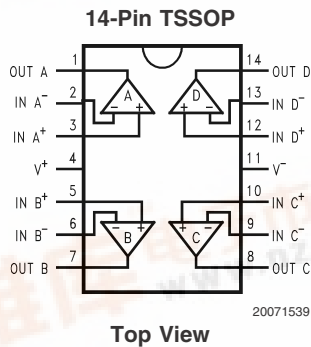
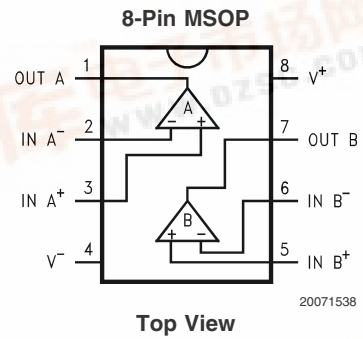
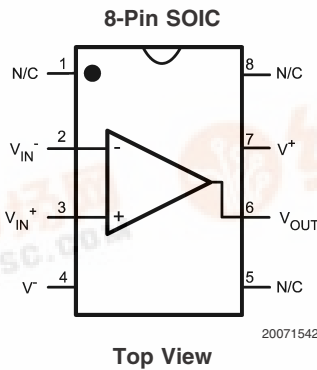
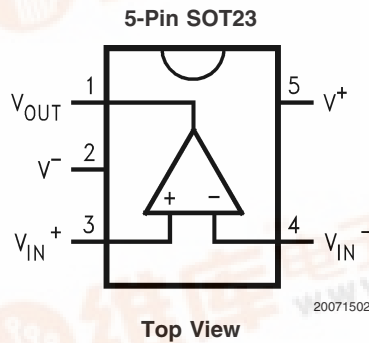

LMP2011 Single/ LMP2012 Dual/ LMP2014 Quad High Precision, Rail-to-Rail Output Operational Amplifier



## Absolute Maximum Ratings (Note 1)

If Military/Aerospace specified devices are required, please contact the National Semiconductor Sales Office/ Distributors for availability and specifications.

ESD Tolerance		
Human Body Model		2000V
Machine Model		200V
Supply Voltage		5.8V
Common-Mode Input Voltage	$-0.3 \leq V_{CM} \leq V_{CC} + 0.3V$	
Lead Temperature (soldering 10 sec.)		+300°C
Differential Input Voltage	$\pm$ Supply Voltage	
Current at Input Pin		30 mA

Current at Output Pin	30 mA
Current at Power Supply Pin	50 mA

## Operating Ratings (Note 1)

Supply Voltage	2.7V to 5.25V
Storage Temperature Range	-65°C to 150°C
Operating Temperature Range	
LMP2011MF, LMP2011MFX	-40°C to 125°C
LMP2011MA, LPM2011MAX	-40°C to 125°C
LMP2012MM, LMP2011MMX	-40°C to 125°C
LMP2014SD, LMP2014SDX	-40°C to 125°C
LMP2014MT, LMP2014MTX	0°C to 70°C

## 2.7V DC Electrical Characteristics

Unless otherwise specified, all limits guaranteed for  $T_J = 25^\circ\text{C}$ ,  $V^+ = 2.7\text{V}$ ,  $V^- = 0\text{V}$ ,  $V_{CM} = 1.35\text{V}$ ,  $V_O = 1.35\text{V}$  and  $R_L > 1\text{M}\Omega$ . **Boldface** limits apply at the temperature extremes.

Symbol	Parameter	Conditions	Min (Note 3)	Typ (Note 2)	Max (Note 3)	Units
$V_{OS}$	Input Offset Voltage			0.8	25 <b>60</b>	$\mu\text{V}$
	Offset Calibration Time			0.5	10 <b>12</b>	ms
$TCV_{OS}$	Input Offset Voltage			0.015		$\mu\text{V}/^\circ\text{C}$
	Long-Term Offset Drift			0.006		$\mu\text{V}/\text{month}$
	Lifetime $V_{OS}$ Drift			2.5		$\mu\text{V}$
$I_{IN}$	Input Current			-3		pA
$I_{OS}$	Input Offset Current			6		pA
$R_{IND}$	Input Differential Resistance			9		$\text{M}\Omega$
CMRR	Common Mode Rejection Ratio	$-0.3 \leq V_{CM} \leq 0.9\text{V}$ $0 \leq V_{CM} \leq 0.9\text{V}$		130	95 <b>90</b>	dB
PSRR	Power Supply Rejection Ratio			120	95 <b>90</b>	dB
$A_{VOL}$	Open Loop Voltage Gain	$R_L = 10\text{ k}\Omega$		130	95 <b>90</b>	dB
		$R_L = 2\text{ k}\Omega$		124	90 <b>85</b>	
$V_O$	Output Swing	$R_L = 10\text{ k}\Omega$ to 1.35V $V_{IN}(\text{diff}) = \pm 0.5\text{V}$	2.665	2.68		V
			<b>2.655</b>		0.033	
		$R_L = 2\text{ k}\Omega$ to 1.35V $V_{IN}(\text{diff}) = \pm 0.5\text{V}$	2.630	2.65		V
			<b>2.615</b>		0.061	
$I_O$	Output Current	Sourcing, $V_O = 0\text{V}$ $V_{IN}(\text{diff}) = \pm 0.5\text{V}$		12	5 <b>3</b>	mA
		Sinking, $V_O = 5\text{V}$ $V_{IN}(\text{diff}) = \pm 0.5\text{V}$		18	5 <b>3</b>	
$R_{OUT}$	Output Impedance					$\Omega$
$I_S$	Supply Current per Channel			0.919	1.20 <b>1.50</b>	mA

**2.7V AC Electrical Characteristics**  $T_J = 25^\circ\text{C}$ ,  $V^+ = 2.7\text{V}$ ,  $V^- = 0\text{V}$ ,  $V_{\text{CM}} = 1.35\text{V}$ ,  $V_{\text{O}} = 1.35\text{V}$ , and  $R_L > 1\text{M}\Omega$ . **Boldface** limits apply at the temperature extremes.

Symbol	Parameter	Conditions	Min (Note 3)	Typ (Note 2)	Max (Note 3)	Units
GBW	Gain-Bandwidth Product			3		MHz
SR	Slew Rate			4		V/ $\mu\text{s}$
$\theta_m$	Phase Margin			60		Deg
$G_m$	Gain Margin			-14		dB
$e_n$	Input-Referred Voltage Noise			35		nV/ $\sqrt{\text{Hz}}$
$i_n$	Input-Referred Current Noise					pA/ $\sqrt{\text{Hz}}$
$e_{n\text{p-p}}$	Input-Referred Voltage Noise	$R_S = 100\Omega$ , DC to 10 Hz		850		nV <sub>pp</sub>
$t_{\text{rec}}$	Input Overload Recovery Time			50		ms
$t_s$	Output Settling time	$A_V = +1$ , $R_L = 2\text{ k}\Omega$ 1V Step	1%			ns
			0.1%			
			0.01%			
		$A_V = -1$ , $R_L = 2\text{ k}\Omega$ 1V Step	1%			
			0.1%			
			0.01%			

**5V DC Electrical Characteristics** Unless otherwise specified, all limits guaranteed for  $T_J = 25^\circ\text{C}$ ,  $V^+ = 5\text{V}$ ,  $V^- = 0\text{V}$ ,  $V_{\text{CM}} = 2.5\text{V}$ ,  $V_{\text{O}} = 2.5\text{V}$  and  $R_L > 1\text{M}\Omega$ . **Boldface** limits apply at the temperature extremes.

Symbol	Parameter	Conditions	Min (Note 3)	Typ (Note 2)	Max (Note 3)	Units
$V_{\text{OS}}$	Input Offset Voltage			0.12	25 <b>60</b>	$\mu\text{V}$
	Offset Calibration Time			0.5	10 <b>12</b>	ms
$\text{TCV}_{\text{OS}}$	Input Offset Voltage			0.015		$\mu\text{V}/^\circ\text{C}$
	Long-Term Offset Drift			0.006		$\mu\text{V}/\text{month}$
	Lifetime $V_{\text{OS}}$ Drift			2.5		$\mu\text{V}$
$I_{\text{IN}}$	Input Current			-3		pA
$I_{\text{OS}}$	Input Offset Current			6		pA
$R_{\text{IND}}$	Input Differential Resistance			9		$\text{M}\Omega$
CMRR	Common Mode Rejection Ratio	$-0.3 \leq V_{\text{CM}} \leq 3.2$ $0 \leq V_{\text{CM}} \leq 3.2$		130	100 <b>90</b>	dB
PSRR	Power Supply Rejection Ratio			120	95 <b>90</b>	dB
$A_{\text{VOL}}$	Open Loop Voltage Gain	$R_L = 10\text{ k}\Omega$		130	105 <b>100</b>	dB
		$R_L = 2\text{ k}\Omega$		132	95 <b>90</b>	
$V_{\text{O}}$	Output Swing	$R_L = 10\text{ k}\Omega$ to 2.5V $V_{\text{IN}}(\text{diff}) = \pm 0.5\text{V}$	4.96	4.978		V
			<b>4.95</b>		0.040	
		$R_L = 2\text{ k}\Omega$ to 2.5V $V_{\text{IN}}(\text{diff}) = \pm 0.5\text{V}$	4.895	4.919		V
			<b>4.875</b>		0.091	

### 5V DC Electrical Characteristics

Unless otherwise specified, all limits guaranteed for  $T_J = 25^\circ\text{C}$ ,  $V^+ = 5\text{V}$ ,  $V^- = 0\text{V}$ ,  $V_{CM} = 2.5\text{V}$ ,  $V_O = 2.5\text{V}$  and  $R_L > 1\text{M}\Omega$ . **Boldface** limits apply at the temperature extremes. (Continued)

Symbol	Parameter	Conditions	Min (Note 3)	Typ (Note 2)	Max (Note 3)	Units
$I_O$	Output Current	Sourcing, $V_O = 0\text{V}$ $V_{IN}(\text{diff}) = \pm 0.5\text{V}$		15	<b>8</b> <b>6</b>	mA
		Sinking, $V_O = 5\text{V}$ $V_{IN}(\text{diff}) = \pm 0.5\text{V}$		17	<b>8</b> <b>6</b>	
$R_{OUT}$	Output Impedance					$\Omega$
$I_S$	Supply Current per Channel			0.930	1.20 <b>1.50</b>	mA

### 5V AC Electrical Characteristics

$T_J = 25^\circ\text{C}$ ,  $V^+ = 5\text{V}$ ,  $V^- = 0\text{V}$ ,  $V_{CM} = 2.5\text{V}$ ,  $V_O = 2.5\text{V}$ , and  $R_L > 1\text{M}\Omega$ . **Boldface** limits apply at the temperature extremes.

Symbol	Parameter	Conditions	Min (Note 3)	Typ (Note 2)	Max (Note 3)	Units
GBW	Gain-Bandwidth Product			3		MHz
SR	Slew Rate			4		V/ $\mu\text{s}$
$\theta_m$	Phase Margin			60		deg
$G_m$	Gain Margin			-15		dB
$e_n$	Input-Referred Voltage Noise			35		nV/ $\sqrt{\text{Hz}}$
$i_n$	Input-Referred Current Noise					pA/ $\sqrt{\text{Hz}}$
$e_{n,p-p}$	Input-Referred Voltage Noise	$R_S = 100\Omega$ , DC to 10 Hz		850		nV <sub>pp</sub>
$t_{rec}$	Input Overload Recovery Time			50		ms
$t_S$	Output Settling time	$A_V = +1$ , $R_L = 2\text{ k}\Omega$ 1V Step	1%			ns
			0.1%			
			0.01%			
		$A_V = -1$ , $R_L = 2\text{ k}\Omega$ 1V Step	1%			
			0.1%			
			0.01%			

**Note 1:** Absolute Maximum Ratings indicate limits beyond which damage may occur. Operating Ratings indicate conditions for which the device is intended to be functional, but specific performance is not guaranteed. For guaranteed specifications and test conditions, see the Electrical Characteristics.

**Note 2:** Typical values represent the most likely parametric norm.

**Note 3:** Limits are 100% production tested at  $25^\circ\text{C}$ . Limits over the operating temperature range are guaranteed through correlations using statistical quality control (SQC) method.

## Ordering Information

Package	Part Number	Temperature Range	Package Marking	Transport Media	NSC Drawing
5-Pin SOT23	LMP2011MF	$-40^\circ\text{C}$ to $125^\circ\text{C}$	AN1A	1k Units Tape and Reel	MF05A
	LMP2011MFX			3k Units Tape and Reel	
8-Pin MSOP	LMP2012MM		AP1A	1k Units Tape and Reel	MUA08A
	LMP2012MMX			3.5k Units Tape and Reel	
8-Pin SOIC	LMP2011MA		LMP2011MA	95 Units/Rail	M08A
	LMP2011MAX			2.5k Units Tape and Reel	
14-Pin LLP	LMP2014SD	P2014SD	250 Units Tape and Reel	SRC14A	
	LMP2014SDX		2.5 Units Tape and Reel		
14-Pin TSSOP	LMP2014MT	$0^\circ\text{C}$ to $70^\circ\text{C}$	LMP2014MT	94 Units/Rail	MTC14
	LMP2014MTX			2.5k Units Tape and Reel	

# Typical Performance Characteristics

$T_A=25^\circ\text{C}$ ,  $V_S=5\text{V}$  unless otherwise specified.

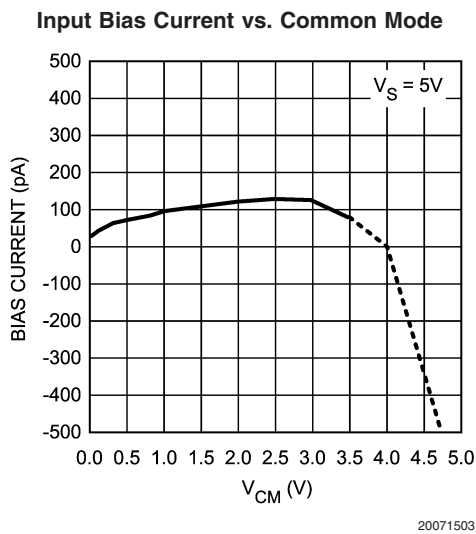
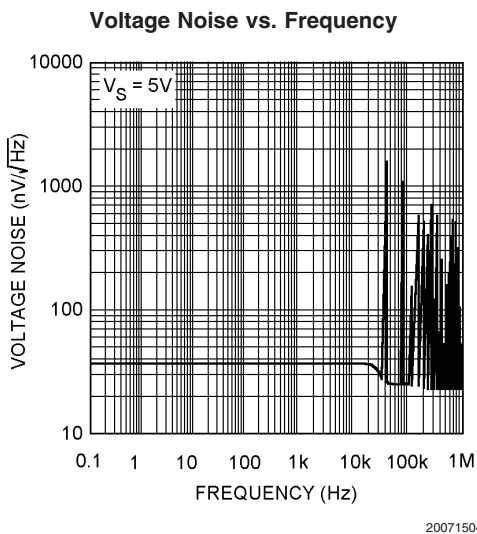
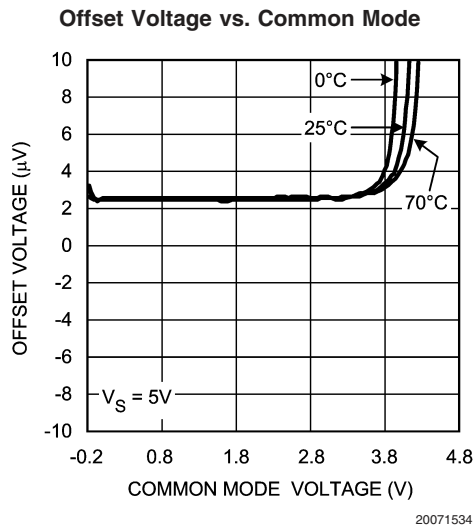
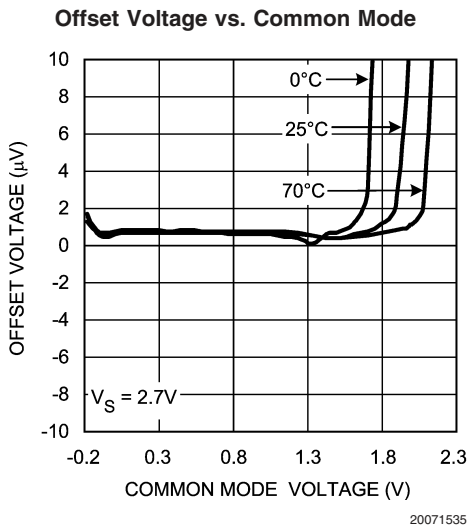
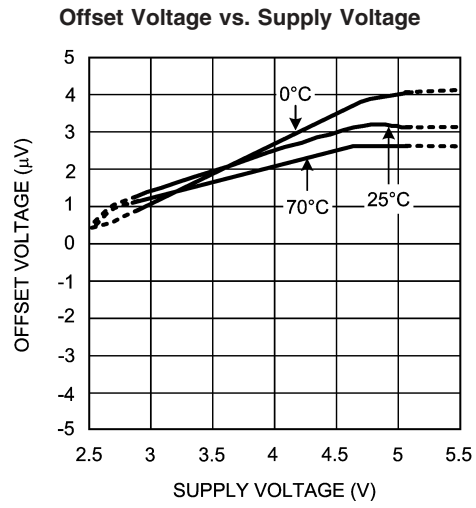
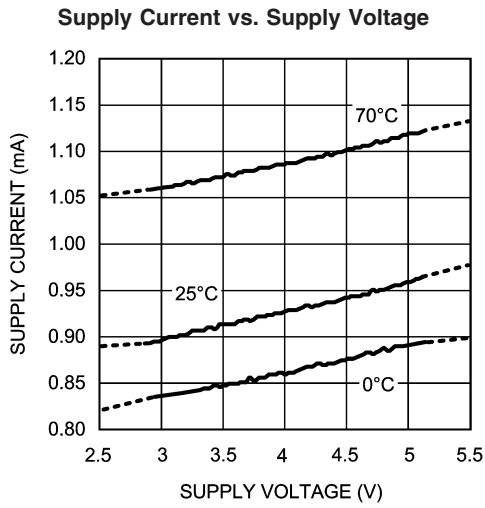

## Typical Performance Characteristics (Continued)

PSRR vs. Frequency

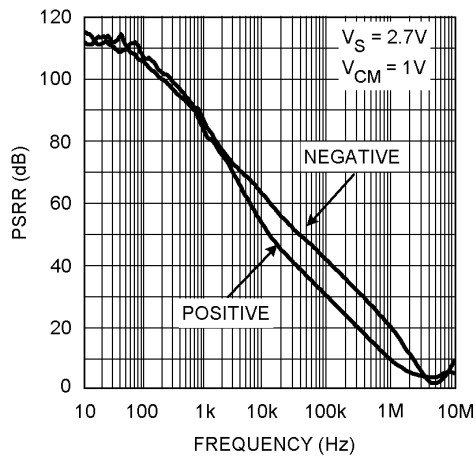

PSRR vs. Frequency

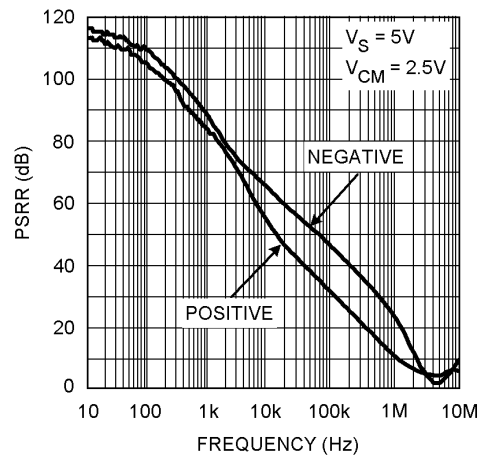

Output Sourcing @ 2.7V

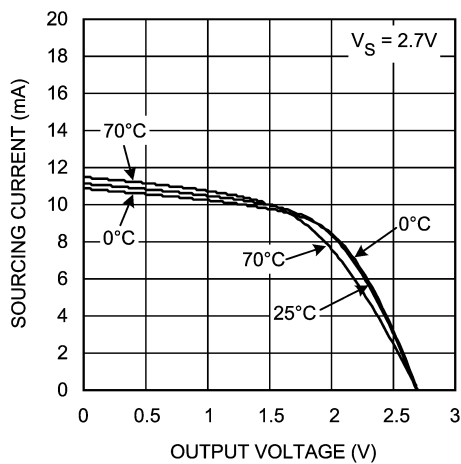

Output Sourcing @ 5V

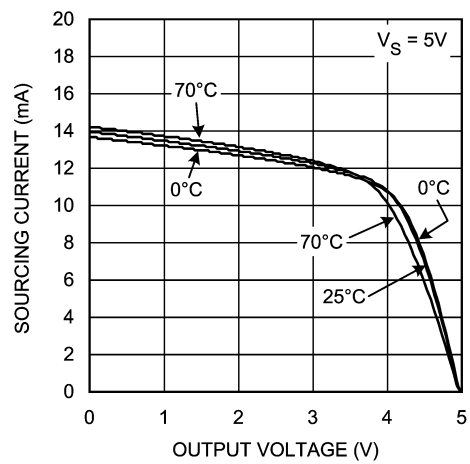

Output Sinking @ 2.7V

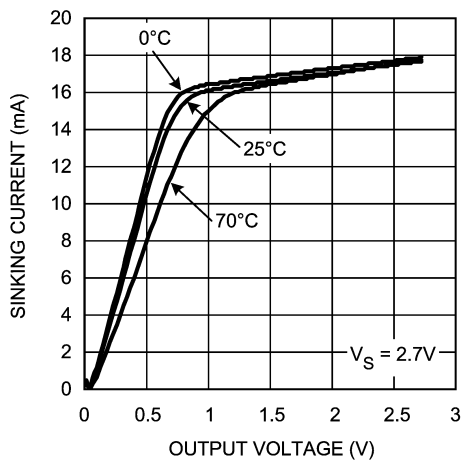

Output Sinking @ 5V

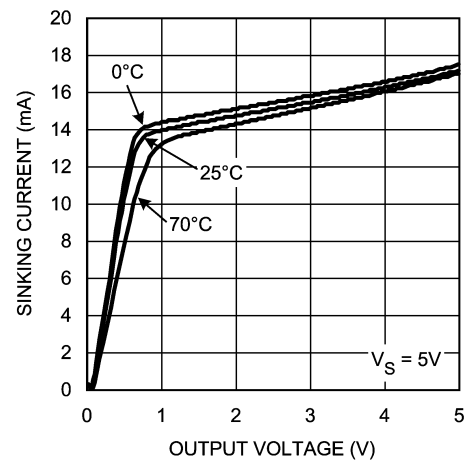

## Typical Performance Characteristics (Continued)

Max Output Swing vs. Supply Voltage

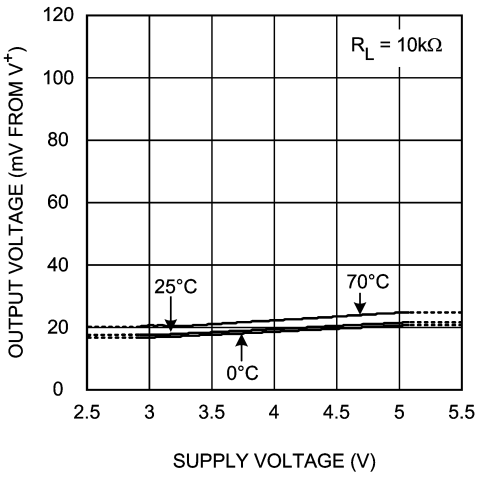

Max Output Swing vs. Supply Voltage

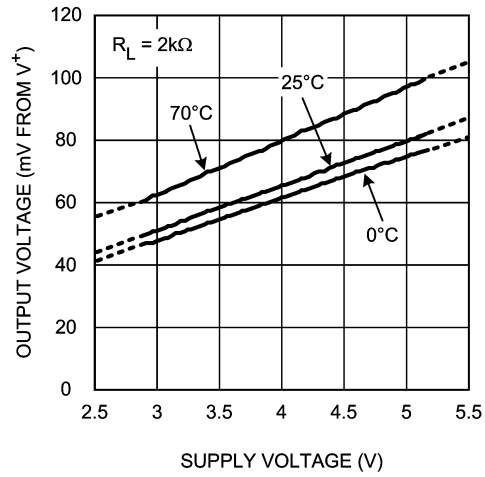

Min Output Swing vs. Supply Voltage

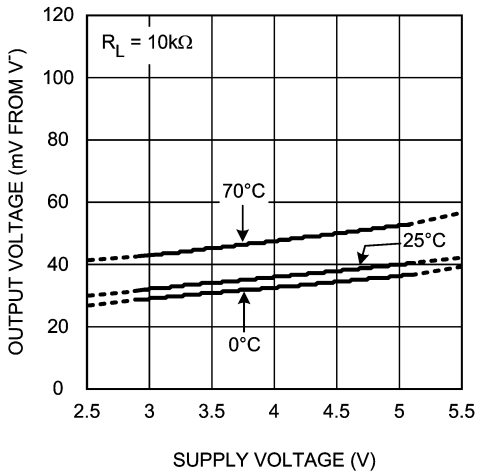

Min Output Swing vs. Supply Voltage

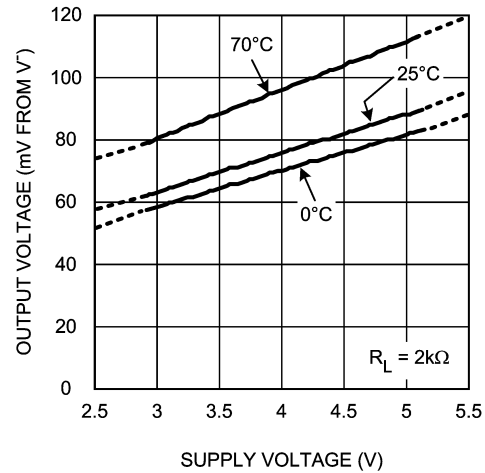

CMRR vs. Frequency

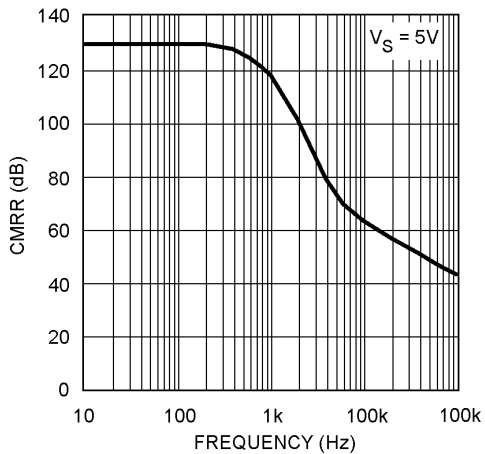

Open Loop Gain and Phase vs. Supply Voltage

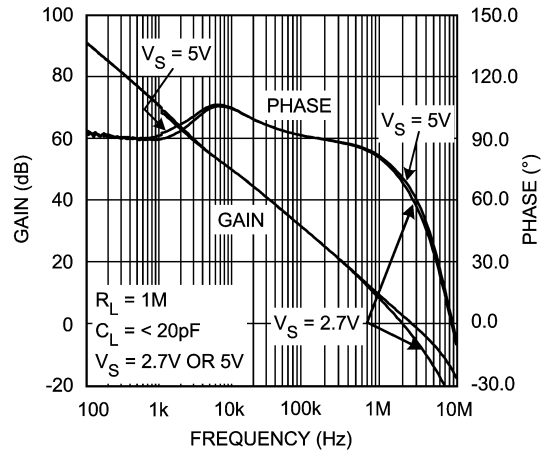

## Typical Performance Characteristics (Continued)

Open Loop Gain and Phase vs.  $R_L$  @ 2.7V

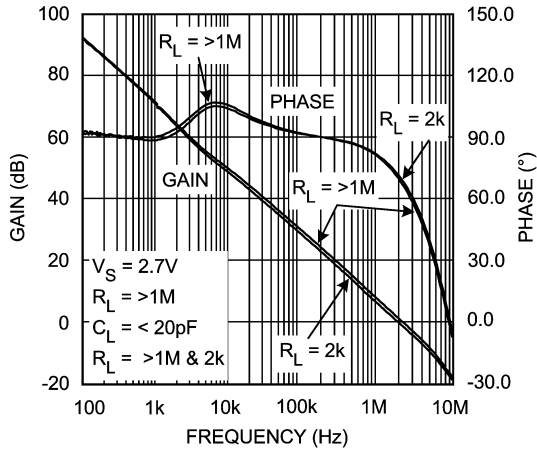

20071509

Open Loop Gain and Phase vs.  $R_L$  @ 5V

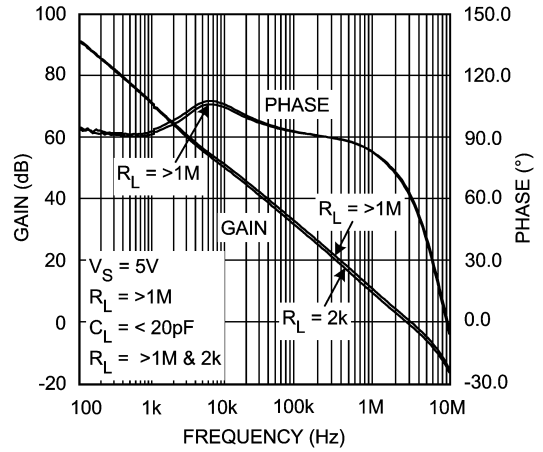

20071510

Open Loop Gain and Phase vs.  $C_L$  @ 2.7V

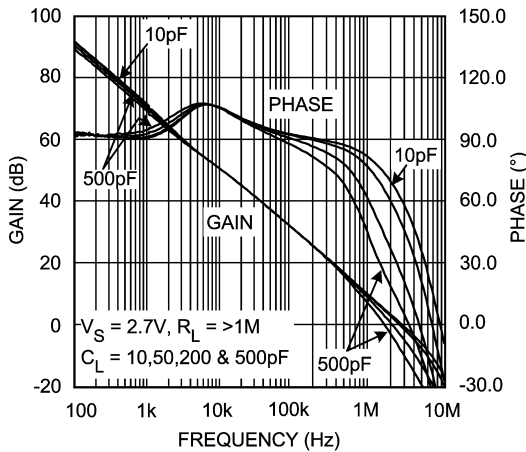

20071511

Open Loop Gain and Phase vs.  $C_L$  @ 5V

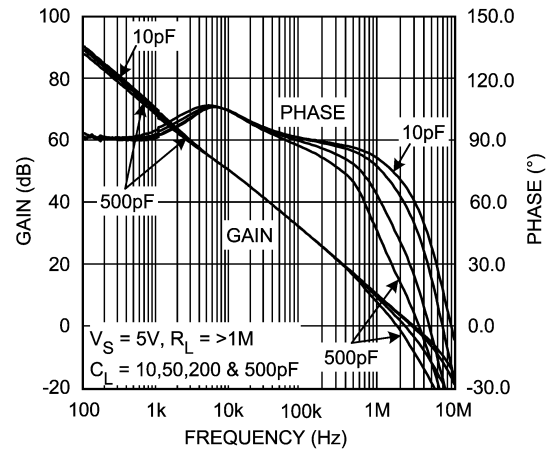

20071512

Open Loop Gain and Phase vs. Temperature @ 2.7V

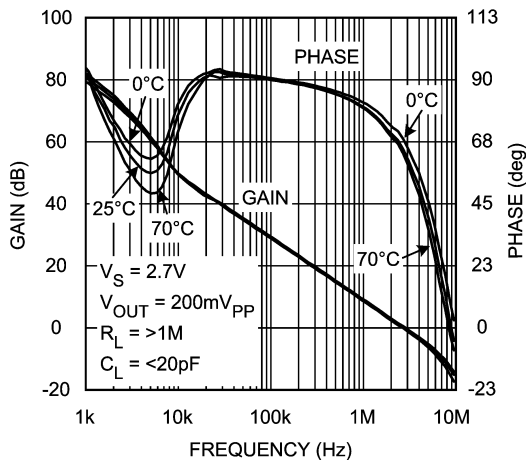

20071536

Open Loop Gain and Phase vs. Temperature @ 5V

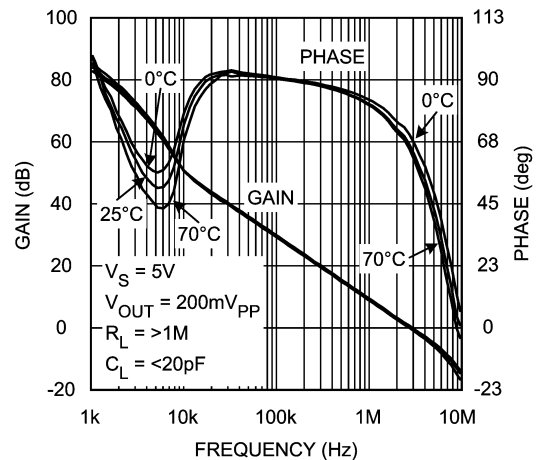

20071537



# Typical Performance Characteristics (Continued)

**THD+N vs. AMPL**

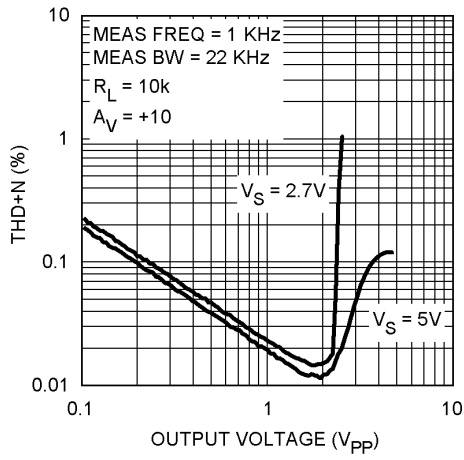

20071514

**THD+N vs. Frequency**

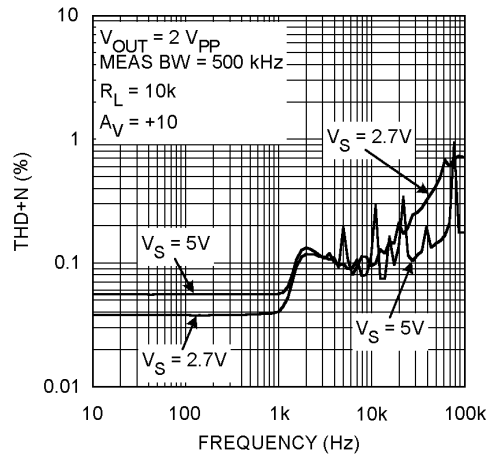

20071513

**0.1 Hz - 10 Hz Noise vs. Time**

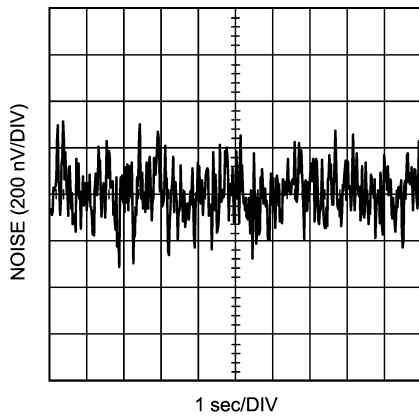

20071515

## Application Information

### THE BENEFITS OF LMP201X NO 1/f NOISE

Using patented methods, the LMP201X eliminates the 1/f noise present in other amplifiers. That noise, which increases as frequency decreases, is a major source of measurement error in all DC-coupled measurements. Low-frequency noise appears as a constantly-changing signal in series with any measurement being made. As a result, even when the measurement is made rapidly, this constantly-changing noise signal will corrupt the result. The value of this noise signal can be surprisingly large. For example: If a conventional amplifier has a flat-band noise level of  $10\text{nV}/\sqrt{\text{Hz}}$  and a noise corner of 10 Hz, the RMS noise at 0.001 Hz is  $1\mu\text{V}/\sqrt{\text{Hz}}$ . This is equivalent to a  $0.50\mu\text{V}$  peak-to-peak error, in the frequency range 0.001 Hz to 1.0 Hz. In a circuit with a gain of 1000, this produces a  $0.50\text{mV}$  peak-to-peak output error. This number of 0.001 Hz might appear unreasonably low, but when a data acquisition system is operating for 17 minutes, it has been on long enough to include this error. In this same time, the LMP201X will only have a  $0.21\text{mV}$  output error. This is smaller by 2.4 x. Keep in mind that this 1/f error gets even larger at lower frequencies. At the extreme, many people try to reduce this error by integrating or taking several samples of the same signal. This is also doomed to failure because the 1/f nature of this noise means that taking longer samples just moves the measurement into lower frequencies where the noise level is even higher.

The LMP201X eliminates this source of error. The noise level is constant with frequency so that reducing the bandwidth reduces the errors caused by noise.

Another source of error that is rarely mentioned is the error voltage caused by the inadvertent thermocouples created when the common "Kovar type" IC package lead materials are soldered to a copper printed circuit board. These steel-based leadframe materials can produce over  $35\mu\text{V}/^\circ\text{C}$  when soldered onto a copper trace. This can result in thermocouple noise that is equal to the LMP201X noise when there is a temperature difference of only  $0.0014^\circ\text{C}$  between the lead and the board!

For this reason, the lead-frame of the LMP201X is made of copper. This results in equal and opposite junctions which cancel this effect. The extremely small size of the SOT-23 package results in the leads being very close together. This further reduces the probability of temperature differences and hence decreases thermal noise.

### OVERLOAD RECOVERY

The LMP201X recovers from input overload much faster than most chopper-stabilized op amps. Recovery from driving the amplifier to 2X the full scale output, only requires about 40 ms. Many chopper-stabilized amplifiers will take from 250 ms to several seconds to recover from this same overload. This is because large capacitors are used to store the unadjusted offset voltage.

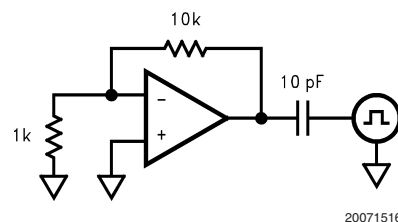

FIGURE 1.

The wide bandwidth of the LMP201X enhances performance when it is used as an amplifier to drive loads that inject transients back into the output. ADCs (Analog-to-Digital Converters) and multiplexers are examples of this type of load. To simulate this type of load, a pulse generator producing a 1V peak square wave was connected to the output through a 10 pF capacitor. (Figure 1) The typical time for the output to recover to 1% of the applied pulse is 80 ns. To recover to 0.1% requires 860ns. This rapid recovery is due to the wide bandwidth of the output stage and large total GBW.

### NO EXTERNAL CAPACITORS REQUIRED

The LMP201X does not need external capacitors. This eliminates the problems caused by capacitor leakage and dielectric absorption, which can cause delays of several seconds from turn-on until the amplifier's error has settled.

### MORE BENEFITS

The LMP201X offers the benefits mentioned above and more. It has a rail-to-rail output and consumes only  $950\mu\text{A}$  of supply current while providing excellent DC and AC electrical performance. In DC performance, the LMP201X achieves 130 dB of CMRR, 120 dB of PSRR and 130 dB of open loop gain. In AC performance, the LMP201X provides 3 MHz of gain-bandwidth product and  $4\text{V}/\mu\text{s}$  of slew rate.

### HOW THE LMP201X WORKS

The LMP201X uses new, patented techniques to achieve the high DC accuracy traditionally associated with chopper-stabilized amplifiers without the major drawbacks produced by chopping. The LMP201X continuously monitors the input offset and corrects this error. The conventional chopping process produces many mixing products, both sums and differences, between the chopping frequency and the incoming signal frequency. This mixing causes large amounts of distortion, particularly when the signal frequency approaches the chopping frequency. Even without an incoming signal, the chopper harmonics mix with each other to produce even more trash. If this sounds unlikely or difficult to understand, look at the plot (Figure 2), of the output of a typical (MAX432) chopper-stabilized op amp. This is the output when there is no incoming signal, just the amplifier in a gain of -10 with the input grounded. The chopper is operating at about 150 Hz; the rest is mixing products. Add an input signal and the noise gets much worse. Compare this plot with Figure 3 of the LMP201X. This data was taken under the exact same conditions. The auto-zero action is visible at about 30 kHz but note the absence of mixing products at other frequencies. As a result, the LMP201X has very low distortion of 0.02% and very low mixing products.

## Application Information (Continued)

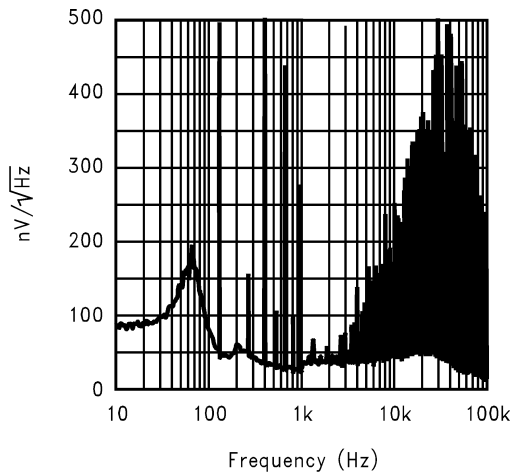

FIGURE 2.

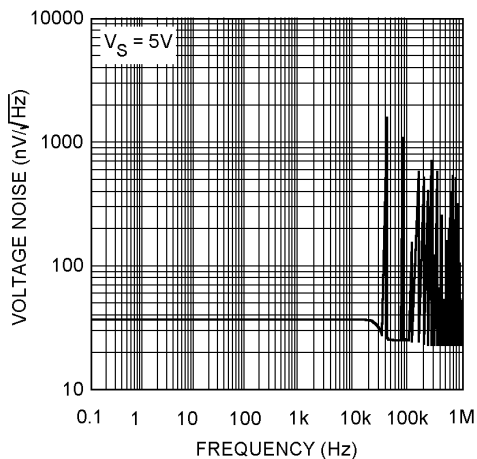

FIGURE 3.

### INPUT CURRENTS

The LMP201X's input currents are different than standard bipolar or CMOS input currents in that it appears as a current flowing in one input and out the other. Under most operating conditions, these currents are in the picoamp level and will have little or no effect in most circuits. These currents tend to increase slightly when the common-mode voltage is near the minus supply. (See the typical curves.) At high temperatures such as 85°C, the input currents become larger, 0.5 nA typical, and are both positive except when the  $V_{CM}$  is near  $V^-$ . If operation is expected at low common-mode voltages and high temperature, do not add resistance in series with the inputs to balance the impedances. Doing this can cause an increase in offset voltage. A small resistance such as 1 kΩ can provide some protection against very large transients or overloads, and will not increase the offset significantly.

### PRECISION STRAIN-GAUGE AMPLIFIER

This Strain-Gauge amplifier (Figure 4) provides high gain (1006 or ~60 dB) with very low offset and drift. Using the resistors' tolerances as shown, the worst case CMRR will be greater than 108 dB. The CMRR is directly related to the resistor mismatch. The rejection of common-mode error, at the output, is independent of the differential gain, which is set by R3. The CMRR is further improved, if the resistor ratio matching is improved, by specifying tighter-tolerance resistors, or by trimming.

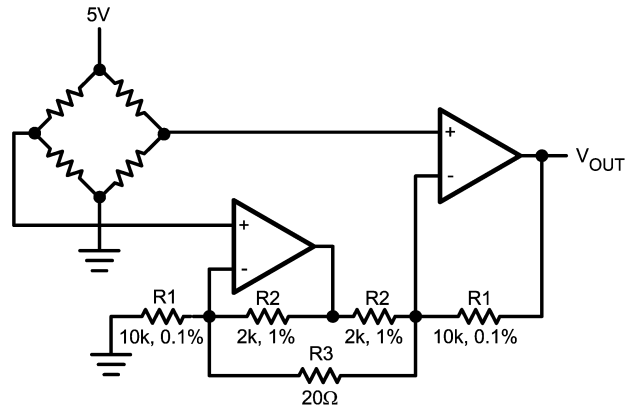

FIGURE 4.

### Extending Supply Voltages and Output Swing by Using a Composite Amplifier Configuration:

In cases where substantially higher output swing is required with higher supply voltages, arrangements like the ones shown in Figure 5 and Figure 6 could be used. These configurations utilize the excellent DC performance of the LMP201X while at the same time allow the superior voltage and frequency capabilities of the LM6171 to set the dynamic performance of the overall amplifier. For example, it is possible to achieve ±12V output swing with 300 MHz of overall GBW ( $A_V = 100$ ) while keeping the worst case output shift due to  $V_{OS}$  less than 4 mV. The LMP201X output voltage is kept at about mid-point of its overall supply voltage, and its input common mode voltage range allows the  $V^-$  terminal to be grounded in one case (Figure 5, inverting operation) and tied to a small non-critical negative bias in another (Figure 6, non-inverting operation). Higher closed-loop gains are also possible with a corresponding reduction in realizable bandwidth. Table 1 shows some other closed loop gain possibilities along with the measured performance in each case.

### Application Information (Continued)

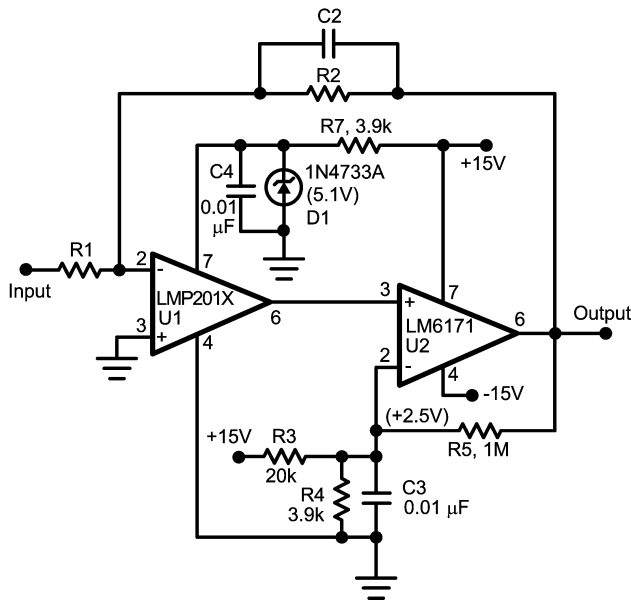

FIGURE 5.

TABLE 1. Composite Amplifier Measured Performance

AV	R1 Ω	R2 Ω	C2 pF	BW MHz	SR (V/μs)	en p-p (mV <sub>PP</sub> )
50	200	10k	8	3.3	178	37
100	100	10k	10	2.5	174	70
100	1k	100k	0.67	3.1	170	70
500	200	100k	1.75	1.4	96	250
1000	100	100k	2.2	0.98	64	400

In terms of the measured output peak-to-peak noise, the following relationship holds between output noise voltage,  $e_n$  p-p, for different closed-loop gain,  $A_V$ , settings, where -3 dB Bandwidth is BW:

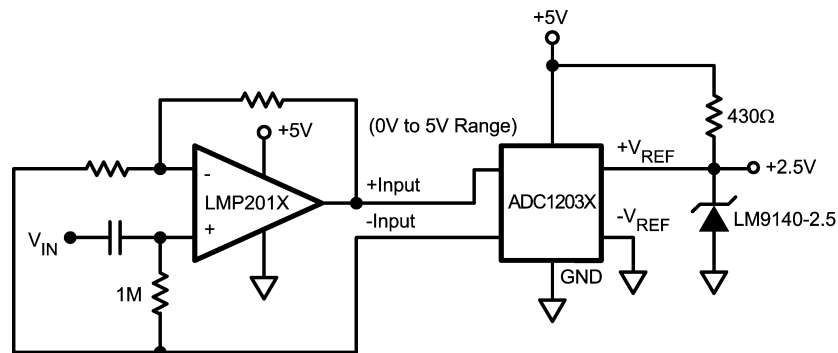

FIGURE 7.

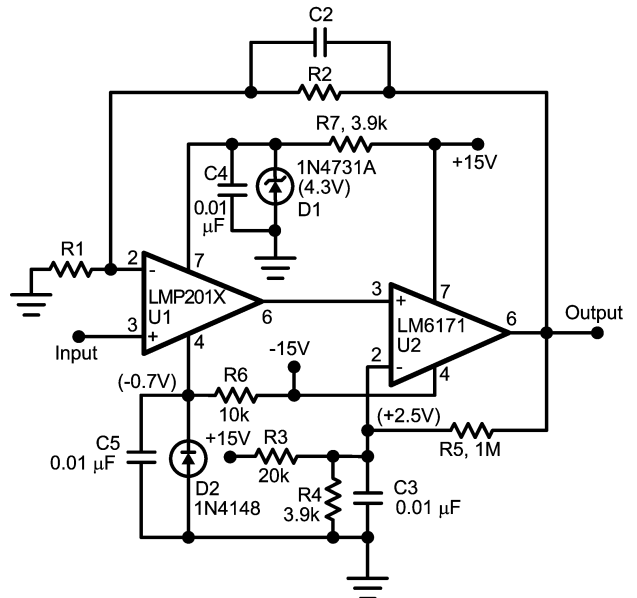

FIGURE 6.

It should be kept in mind that in order to minimize the output noise voltage for a given closed-loop gain setting, one could minimize the overall bandwidth. As can be seen from Equation 1 above, the output noise has a square-root relationship to the Bandwidth.

In the case of the inverting configuration, it is also possible to increase the input impedance of the overall amplifier, by raising the value of R1, without having to increase the feedback resistor, R2, to impractical values, by utilizing a "Tee" network as feedback. See the LMC6442 data sheet (Application Notes section) for more details on this.

## Application Information (Continued)

### LMP201X AS ADC INPUT AMPLIFIER

The LMP201X is a great choice for an amplifier stage immediately before the input of an ADC (Analog-to-Digital Converter), whether AC or DC coupled. See *Figure 7* and *Figure 8*. This is because of the following important characteristics:

- A) Very low offset voltage and offset voltage drift over time and temperature allow a high closed-loop gain setting without introducing any short-term or long-term errors. For example, when set to a closed-loop gain of 100 as the analog input amplifier for a 12-bit A/D converter, the overall conversion error over full operation temperature and 30 years life of the part (operating at 50°C) would be less than 5 LSBs.
- B) Fast large-signal settling time to 0.01% of final value (1.4  $\mu$ s) allows 12 bit accuracy at 100 KHz or more sampling rate.
- C) No flicker (1/f) noise means unsurpassed data accuracy over any measurement period of time, no matter how long. Consider the following op amp performance, based on a typical low-noise, high-performance commercially-available device, for comparison:  
Op amp flatband noise =  $8nV/\sqrt{Hz}$

1/f corner frequency = 100 Hz

$A_V = 2000$

Measurement time = 100 sec

Bandwidth = 2 Hz

This example will result in about 2.2 mV<sub>PP</sub> (1.9 LSB) of output noise contribution due to the op amp alone, compared to about 594  $\mu$ V<sub>PP</sub> (less than 0.5 LSB) when that op amp is replaced with the LMP201X which has no 1/f contribution. If the measurement time is increased from 100 seconds to 1 hour, the improvement realized by using the LMP201X would be a factor of about 4.8 times (2.86 mV<sub>PP</sub> compared to 596  $\mu$ V when LMP201X is used) mainly because the LMP201X accuracy is not compromised by increasing the observation time.

- D) Copper leadframe construction minimizes any thermocouple effects which would degrade low level/high gain data conversion application accuracy (see discussion under "The Benefits of the LMP201X" section above).
- E) Rail-to-Rail output swing maximizes the ADC dynamic range in 5-Volt single-supply converter applications. Below are some typical block diagrams showing the LMP201X used as an ADC amplifier (*Figure 7* and *Figure 8*).

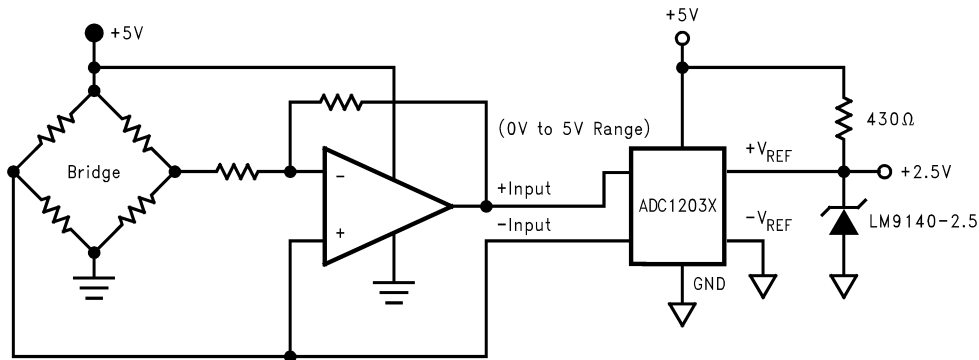

20071522

FIGURE 8.

**Physical Dimensions** inches (millimeters) unless otherwise noted

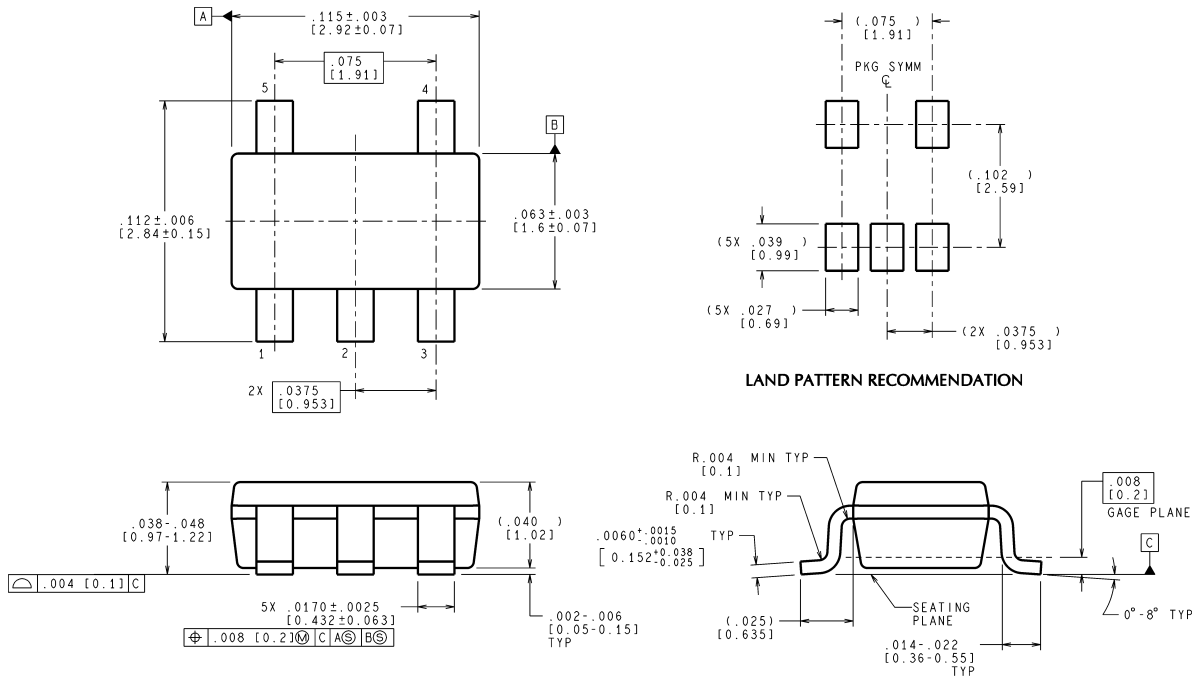

CONTROLLING DIMENSION IS INCH  
VALUES IN [ ] ARE MILLIMETERS

MF05A (Rev B)

**5-Pin SOT23**  
**NS Package Number MF0A5**

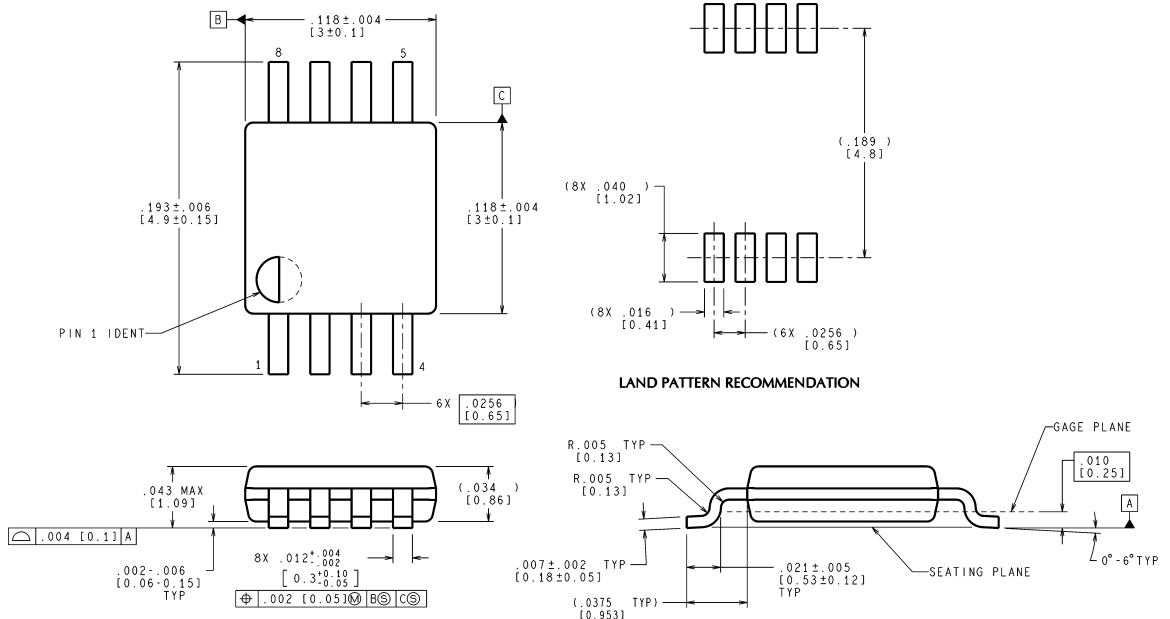

CONTROLLING DIMENSION IS INCH  
VALUES IN [ ] ARE MILLIMETERS

MUA08A (Rev E)

**8-Pin MSOP**  
**NS Package Number MUA08A**

**Physical Dimensions** inches (millimeters) unless otherwise noted (Continued)

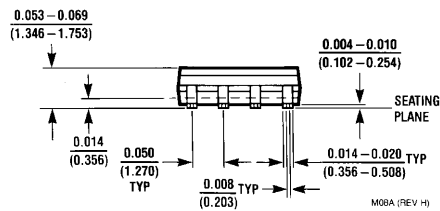
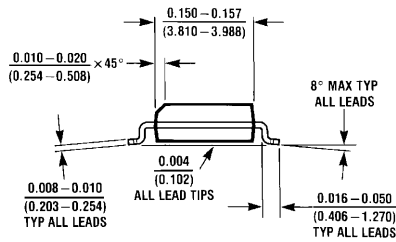
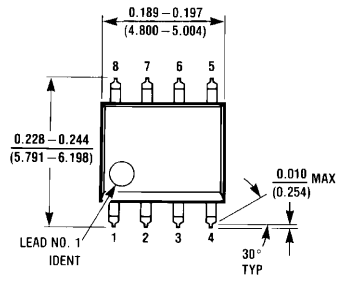

**8-Pin SOIC**  
NS Package Number M08A

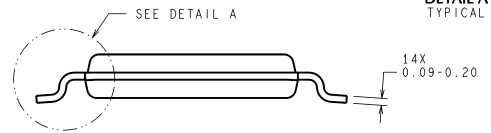
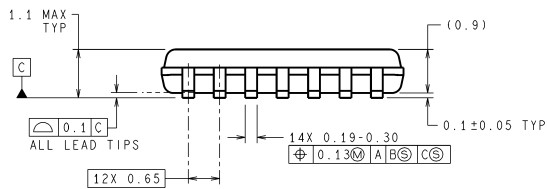
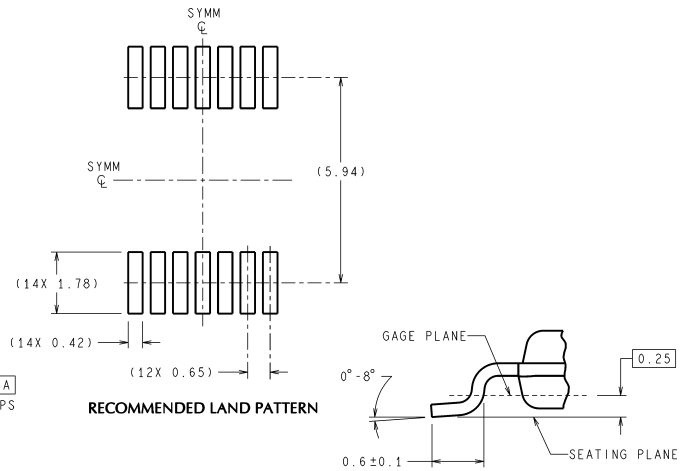
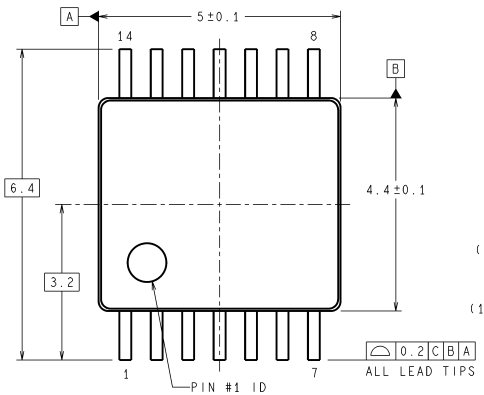

DIMENSIONS ARE IN MILLIMETERS  
DIMENSIONS IN ( ) FOR REFERENCE ONLY

MTC14 (Rev D)

**14-Pin TSSOP**  
NS Package Number MTC14

**Physical Dimensions** inches (millimeters) unless otherwise noted (Continued)

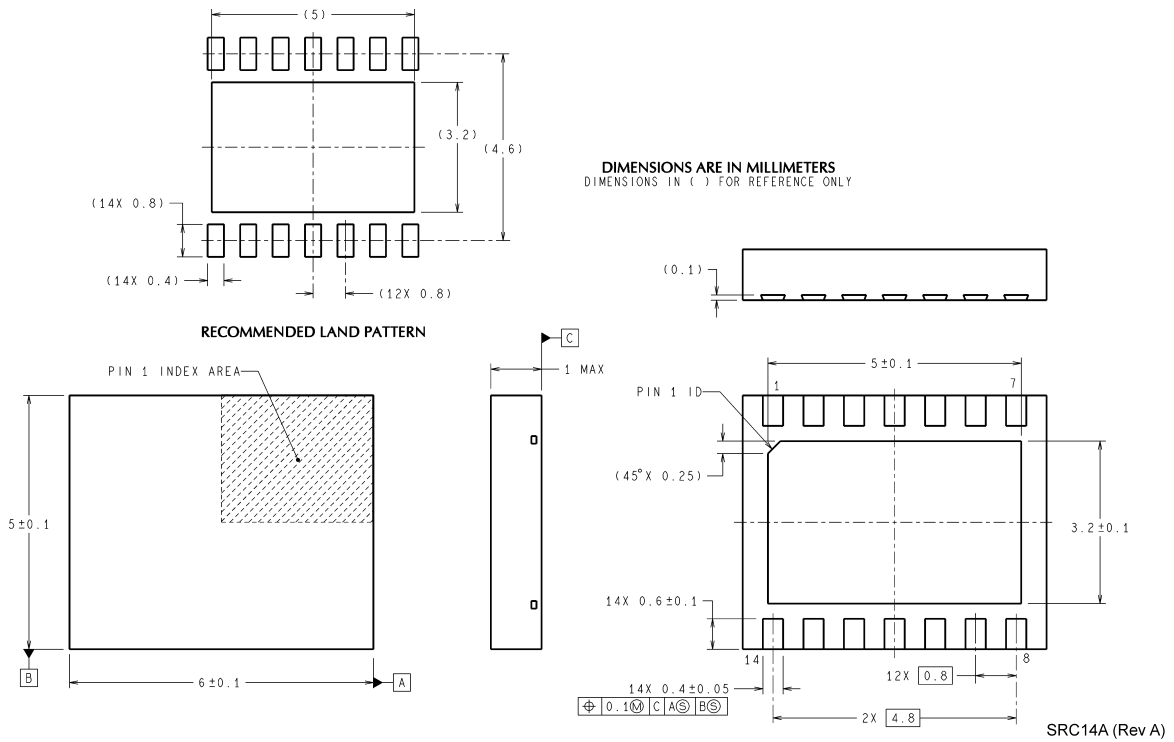

**14-LLP**  
**NS Package Number SRC14A**

National does not assume any responsibility for use of any circuitry described, no circuit patent licenses are implied and National reserves the right at any time without notice to change said circuitry and specifications.

For the most current product information visit us at [www.national.com](http://www.national.com).

**LIFE SUPPORT POLICY**

NATIONAL'S PRODUCTS ARE NOT AUTHORIZED FOR USE AS CRITICAL COMPONENTS IN LIFE SUPPORT DEVICES OR SYSTEMS WITHOUT THE EXPRESS WRITTEN APPROVAL OF THE PRESIDENT AND GENERAL COUNSEL OF NATIONAL SEMICONDUCTOR CORPORATION. As used herein:

1. Life support devices or systems are devices or systems which, (a) are intended for surgical implant into the body, or (b) support or sustain life, and whose failure to perform when properly used in accordance with instructions for use provided in the labeling, can be reasonably expected to result in a significant injury to the user.
2. A critical component is any component of a life support device or system whose failure to perform can be reasonably expected to cause the failure of the life support device or system, or to affect its safety or effectiveness.

**BANNED SUBSTANCE COMPLIANCE**

National Semiconductor certifies that the products and packing materials meet the provisions of the Customer Products Stewardship Specification (CSP-9-111C2) and the Banned Substances and Materials of Interest Specification (CSP-9-111S2) and contain no "Banned Substances" as defined in CSP-9-111S2.



**National Semiconductor**  
**Americas Customer**  
**Support Center**  
Email: [new.feedback@nsc.com](mailto:new.feedback@nsc.com)  
Tel: 1-800-272-9959

**National Semiconductor**  
**Europe Customer Support Center**  
Fax: +49 (0) 180-530 85 86  
Email: [europe.support@nsc.com](mailto:europe.support@nsc.com)  
Deutsch Tel: +49 (0) 69 9508 6208  
English Tel: +44 (0) 870 24 0 2171  
Français Tel: +33 (0) 1 41 91 8790

**National Semiconductor**  
**Asia Pacific Customer**  
**Support Center**  
Email: [ap.support@nsc.com](mailto:ap.support@nsc.com)

**National Semiconductor**  
**Japan Customer Support Center**  
Fax: 81-3-5639-7507  
Email: [jpn.feedback@nsc.com](mailto:jpn.feedback@nsc.com)  
Tel: 81-3-5639-7560