

LMV791/LMV792

17 MHz, Low Noise, CMOS Input, 1.8V Operational Amplifiers with Shutdown

General Description

The LMV791 (Single) and the LMV792 (Dual) low noise, CMOS input operational amplifiers offer a low input voltage noise density of 5.8 nV/√Hz while consuming only 1.15 mA (LMV791) of quiescent current. The LMV791 and LMV792 are unity gain stable op amps and have gain bandwidth of 17 MHz. The LMV791/LMV792 have a supply voltage range of 1.8V to 5.5V and can operate from a single supply. The LMV791/LMV792 each feature a rail-to-rail output stage capable of driving a 600Ω load and sourcing as much as 60 mA of current.

The LMV791 family provides optimal performance in low voltage and low noise systems. A CMOS input stage, with typical input bias currents in the range of a few femtoAmperes, and an input common mode voltage range which includes ground make the LMV791 and the LMV792 ideal for low power sensor applications. The LMV791 family has a built-in enable feature which can be used to optimize power dissipation in low power applications.

The LMV791/LMV792 are manufactured using National's advanced VIP50 process and are offered in a 6-pin TSOT23 and a 10-pin MSOP package respectively.

Features

(Typical 5V supply, unless otherwise noted)

- Input referred voltage noise 5.8 nV/√Hz
- Input bias current 100 fA
- Unity gain bandwidth 17 MHz
- Supply current per channel enable mode
 - LMV791 1.15 mA
 - LMV792 1.30 mA
- Supply current per channel in shutdown mode 0.02 μA
- Rail-to-rail output swing
 - @ 10 kΩ load 25 mV from rail
 - @ 2 kΩ load 35 mV from rail
- Guaranteed 2.5V and 5.0V performance
- Total harmonic distortion 0.01% @1 kHz, 600Ω
- Temperature range -40°C to 125°C

Applications

- Photodiode amplifiers
- Active filters and buffers
- Low noise signal processing
- Medical Instrumentation
- Sensor interface applications

Typical Application

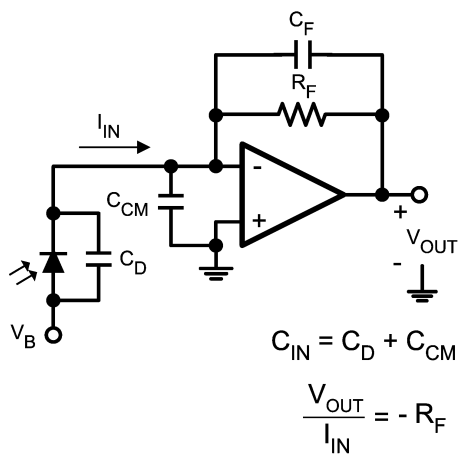

Photodiode Transimpedance Amplifier

20116869

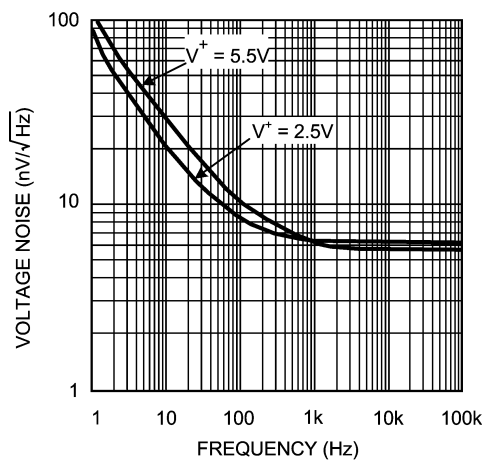

Input Referred Voltage Noise vs. Frequency

20116839

Absolute Maximum Ratings (Note 1)

If Military/Aerospace specified devices are required, please contact the National Semiconductor Sales Office/Distributors for availability and specifications.

ESD Tolerance (Note 2)	
Human Body Model	2000V
Machine Model	200V
V_{IN} Differential	$\pm 0.3V$
Supply Voltage ($V^+ - V^-$)	6.0V
Input/Output Pin Voltage	$V^+ + 0.3V, V^- - 0.3V$
Storage Temperature Range	$-65^\circ C$ to $150^\circ C$
Junction Temperature (Note 3)	$+150^\circ C$

Soldering Information

Infrared or Convection (20 sec)	$235^\circ C$
Wave Soldering Lead Temp (10 sec)	$260^\circ C$

Operating Ratings (Note 1)

Temperature Range (Note 3)	$-40^\circ C$ to $125^\circ C$
Supply Voltage ($V^+ - V^-$)	2.0V to 5.5V
$-40^\circ C \leq T_A \leq 125^\circ C$	1.8V to 5.5V
$0^\circ C \leq T_A \leq 125^\circ C$	
Package Thermal Resistance (θ_{JA} (Note 3))	
6-Pin TSOT23	$170^\circ C/W$
10-Pin MSOP	$236^\circ C/W$

2.5V Electrical Characteristics

Unless otherwise specified, all limits are guaranteed for $T_A = 25^\circ C$, $V^+ = 2.5V$, $V^- = 0V$, $V_{CM} = V^+/2 = V_O$, $V_{EN} = V^+$. **Boldface** limits apply at the temperature extremes.

Symbol	Parameter	Conditions	Min (Note 5)	Typ (Note 4)	Max (Note 5)	Units
V_{OS}	Input Offset Voltage			0.1	± 1.35 ± 1.65	mV
TC V_{OS}	Input Offset Average Drift	LMV791 (Note 6)		-1.0		$\mu V/^\circ C$
		LMV792 (Note 6)		-1.8		
I_B	Input Bias Current	$V_{CM} = 1.0V$ (Notes 7, 8)	$-40^\circ C \leq T_A \leq 85^\circ C$	0.05	1 25	pA
			$-40^\circ C \leq T_A \leq 125^\circ C$	0.05	1 100	
I_{OS}	Input Offset Current	(Note 8)		10		fA
CMRR	Common Mode Rejection Ratio	$0V \leq V_{CM} \leq 1.4V$	80 75	94		dB
PSRR	Power Supply Rejection Ratio	$2.0V \leq V^+ \leq 5.5V, V_{CM} = 0V$	80 75	100		dB
		$1.8V \leq V^+ \leq 5.5V, V_{CM} = 0V$	80	98		
CMVR	Input Common-Mode Voltage Range	CMRR ≥ 60 dB CMRR ≥ 55 dB	-0.3 -0.3		1.5 1.5	V
A_{VOL}	Large Signal Voltage Gain	$V_{OUT} = 0.15V$ to $2.2V$, $R_{LOAD} = 2$ k Ω to $V^+/2$	LMV791	85 80	98	dB
			LMV792	82 78	92	
		$V_{OUT} = 0.15V$ to $2.2V$, $R_{LOAD} = 10$ k Ω to $V^+/2$		88 84	110	
V_{OUT}	Output Swing High	$R_{LOAD} = 2$ k Ω to $V^+/2$		25	75 82	mV from rail
		$R_{LOAD} = 10$ k Ω to $V^+/2$		20	65 71	
	Output Swing Low	$R_{LOAD} = 2$ k Ω to $V^+/2$		30	75 78	
		$R_{LOAD} = 10$ k Ω to $V^+/2$		15	65 67	

2.5V Electrical Characteristics (Continued)

I_{OUT}	Output Short Circuit Current	Sourcing to V^- $V_{IN} = 200\text{ mV}$ (Note 9)	35 28	47		mA	
		Sinking to V^+ $V_{IN} = -200\text{ mV}$ (Note 9)	7 5	15			
I_S	Supply Current per Amplifier	Enable Mode $V_{EN} \geq 2.1\text{V}$	LMV791		0.95	1.30 1.65	mA
			LMV792 per channel		1.1	1.50 1.85	
		Shutdown Mode, $V_{EN} < 0.4$ per channel		0.02	1 5	μA	
SR	Slew Rate	$A_V = +1$, Rising (10% to 90%)		8.5		$\text{V}/\mu\text{s}$	
		$A_V = +1$, Falling (90% to 10%)		10.5			
GBWP	Gain Bandwidth Product			14		MHz	
e_n	Input-Referred Voltage Noise	$f = 1\text{ kHz}$		6.2		$\text{nV}/\sqrt{\text{Hz}}$	
i_n	Input-Referred Current Noise	$f = 1\text{ kHz}$		0.01		$\text{pA}/\sqrt{\text{Hz}}$	
t_{on}	Turn-on Time			140		ns	
t_{off}	Turn-off Time			1000		ns	
V_{EN}	Enable Pin Voltage Range	Enable Mode	2.1	2 to 2.5		V	
		Shutdown Mode		0 to 0.5	0.4		
I_{EN}	Enable Pin Input Current	Enable Mode $V_{EN} = 2.5\text{V}$ (Note 7)		1.5	3	μA	
		Shutdown Mode $V_{EN} = 0\text{V}$ (Note 7)		0.003	0.1		
THD+N	Total Harmonic Distortion + Noise	$f = 1\text{ kHz}$, $A_V = 1$, $R_{LOAD} = 600\Omega$		0.01		%	

5V Electrical Characteristics

Unless otherwise specified, all limits are guaranteed for $T_A = 25^\circ\text{C}$, $V^+ = 5\text{V}$, $V^- = 0\text{V}$, $V_{CM} = V^+/2 = V_O$, $V_{EN} = V^+$. **Boldface** limits apply at the temperature extremes.

Symbol	Parameter	Conditions	Min (Note 5)	Typ (Note 4)	Max (Note 5)	Units
V_{OS}	Input Offset Voltage			0.1	± 1.35 ± 1.65	mV
TC V_{OS}	Input Offset Average Drift	LMV791 (Note 6)		-1.0		$\mu\text{V}/^\circ\text{C}$
		LMV792 (Note 6)		-1.8		
I_B	Input Bias Current	$V_{CM} = 2.0\text{V}$ (Notes 7, 8)	$-40^\circ\text{C} \leq T_A \leq 85^\circ\text{C}$	0.1	1 25	pA
			$-40^\circ\text{C} \leq T_A \leq 125^\circ\text{C}$		0.1	
I_{OS}	Input Offset Current	(Note 8)		10		fA
CMRR	Common Mode Rejection Ratio	$0\text{V} \leq V_{CM} \leq 3.7\text{V}$	80 75	100		dB
PSRR	Power Supply Rejection Ratio	$2.0\text{V} \leq V^+ \leq 5.5\text{V}$, $V_{CM} = 0\text{V}$	80 75	100		dB
		$1.8\text{V} \leq V^+ \leq 5.5\text{V}$, $V_{CM} = 0\text{V}$	80	98		
CMVR	Input Common-Mode Voltage Range	CMRR $\geq 60\text{ dB}$ CMRR $\geq 55\text{ dB}$	-0.3 -0.3		4 4	V
A_{VOL}	Large Signal Voltage Gain	$V_{OUT} = 0.3\text{V}$ to 4.7V , $R_{LOAD} = 2\text{ k}\Omega$ to $V^+/2$	LMV791	85 80	97	dB
			LMV792	82 78	89	
		$V_{OUT} = 0.3\text{V}$ to 4.7V , $R_{LOAD} = 10\text{ k}\Omega$ to $V^+/2$		88 84	110	

5V Electrical Characteristics (Continued)

V _{OUT}	Output Swing High	R _{LOAD} = 2 kΩ to V ⁺ /2		35	75	mV from rail	
		R _{LOAD} = 10 kΩ to V ⁺ /2		25	65		
	Output Swing Low	R _{LOAD} = 2 kΩ to V ⁺ /2	LMV791	42	75		
			LMV792	50	80		
		R _{LOAD} = 10 kΩ to V ⁺ /2		20	65		
I _{OUT}	Output Short Circuit Current	Sourcing to V ⁻ V _{IN} = 200 mV (Note 9)		45	60	mA	
		Sinking to V ⁺ V _{IN} = -200 mV (Note 9)		10	21		
I _S	Supply Current per Amplifier	Enable Mode V _{EN} ≥ 4.6V	LMV791	1.15	1.40	mA	
			LMV792 per channel	1.30	1.70		
		Shutdown Mode (V _{EN} ≤ 0.4V)			0.14	1	μA
SR	Slew Rate	A _V = +1, Rising (10% to 90%)		6.0	9.5	V/μs	
		A _V = +1, Falling (90% to 10%)		7.5	11.5		
GBWP	Gain Bandwidth Product			17		MHz	
e _n	Input-Referred Voltage Noise	f = 1 kHz		5.8		nV/√Hz	
i _n	Input-Referred Current Noise	f = 1 kHz		0.01		pA/√Hz	
t _{on}	Turn-on Time			110		ns	
t _{off}	Turn-off Time			800		ns	
V _{EN}	Enable Pin Voltage Range	Enable Mode		4.6	4.5 to 5	V	
		Shutdown Mode			0 to 0.5		
I _{EN}	Enable Pin Input Current	Enable Mode V _{EN} = 5.0V (Note 7)			5.6	10	μA
		Shutdown Mode V _{EN} = 0V (Note 7)			0.005	0.2	
THD+N	Total Harmonic Distortion + Noise	f = 1 kHz, A _V = 1, R _{LOAD} = 600Ω			0.01		%

Note 1: Absolute Maximum Ratings indicate limits beyond which damage to the device may occur. Operating Ratings indicate conditions for which the device is intended to be functional, but specific performance is not guaranteed. For guaranteed specifications and the test conditions, see the Electrical Characteristics Tables.

Note 2: Human Body Model is 1.5 kΩ in series with 100 pF. Machine Model is 0Ω in series with 200 pF

Note 3: The maximum power dissipation is a function of T_{J(MAX)}, θ_{JA}. The maximum allowable power dissipation at any ambient temperature is P_D = (T_{J(MAX)} - T_A)/θ_{JA}. All numbers apply for packages soldered directly onto a PC Board.

Note 4: Typical values represent the parametric norm at the time of characterization.

Note 5: Limits are 100% production tested at 25°C. Limits over the operating temperature range are guaranteed through correlations using the statistical quality control (SQC) method.

Note 6: Offset voltage average drift is determined by dividing the change in V_{OS} by temperature change.

Note 7: Positive current corresponds to current flowing into the device.

Note 8: Input bias current and input offset current are guaranteed by design

Note 9: The short circuit test is a momentary test, the short circuit duration is 1.5 ms.

Connection Diagrams

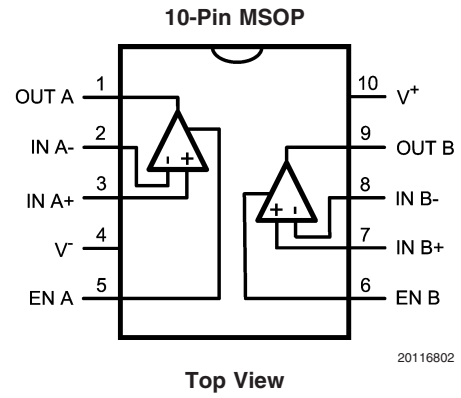
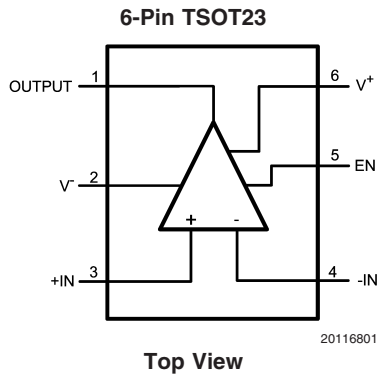

Ordering Information

Package	Part Number	Package Marking	Transport Media	NSC Drawing
6-Pin TSOT23	LMV791MK	AS1A	1k Units Tape and Reel	MK06A
	LMV791MKX		3k Units Tape and Reel	
10-Pin MSOP	LMV792MM	AX2A	1k Units Tape and Reel	MUB10A
	LMV792MMX		3.5k Units Tape and Reel	

Typical Performance Characteristics

Unless otherwise specified, $T_A = 25^\circ\text{C}$, $V^- = 0$, $V^+ = \text{Supply}$

Voltage = 5V, $V_{CM} = V^+/2$, $V_{EN} = V^+$.

Supply Current vs. Supply Voltage (LMV791)

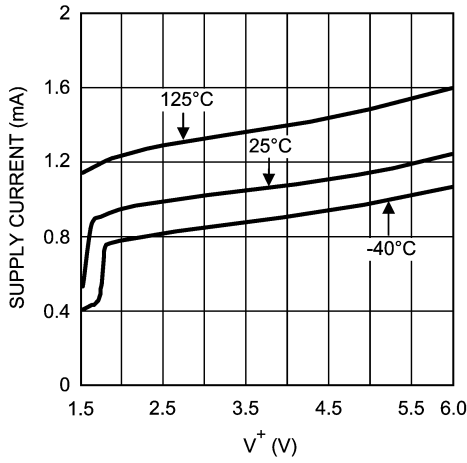

20116805

Supply Current vs. Supply Voltage (LMV792)

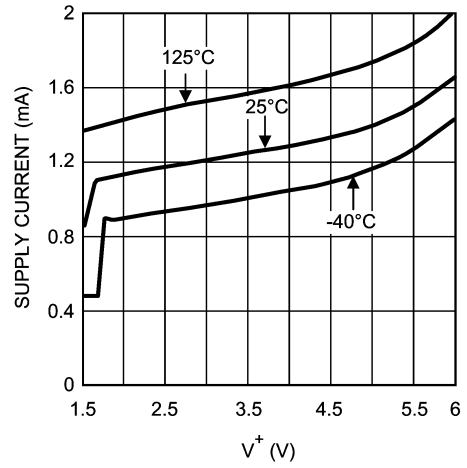

20116881

Supply Current vs. Supply Voltage in Shutdown Mode

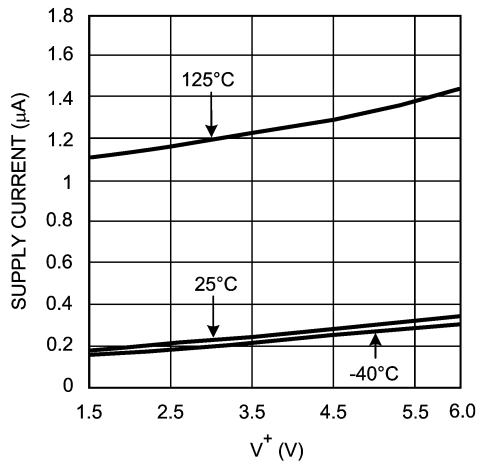

20116806

V_{OS} vs. V_{CM}

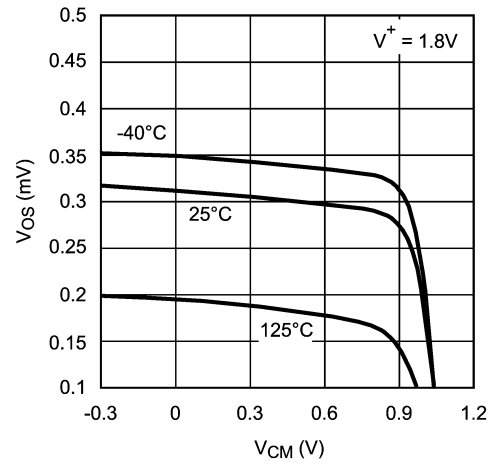

20116809

V_{OS} vs. V_{CM}

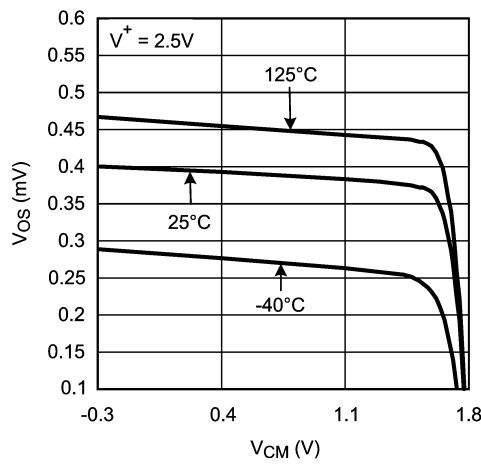

20116851

V_{OS} vs. V_{CM}

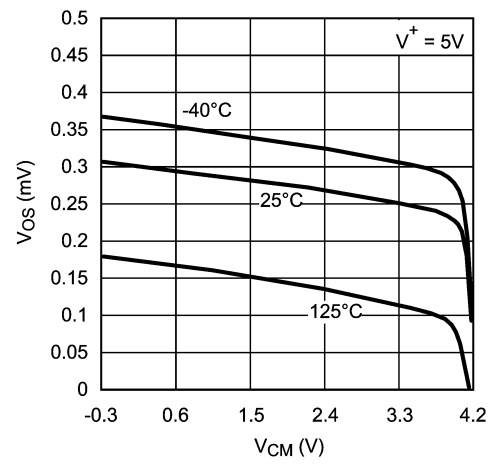

20116811

Typical Performance Characteristics Unless otherwise specified, $T_A = 25^\circ\text{C}$, $V^- = 0$, $V^+ = \text{Supply}$
 Voltage = 5V, $V_{CM} = V^+/2$, $V_{EN} = V^+$. (Continued)

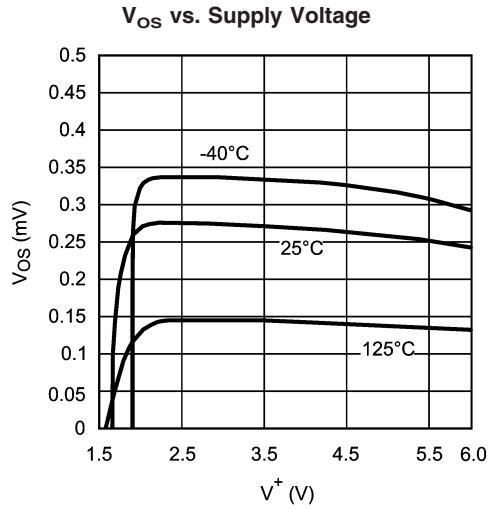

20116812

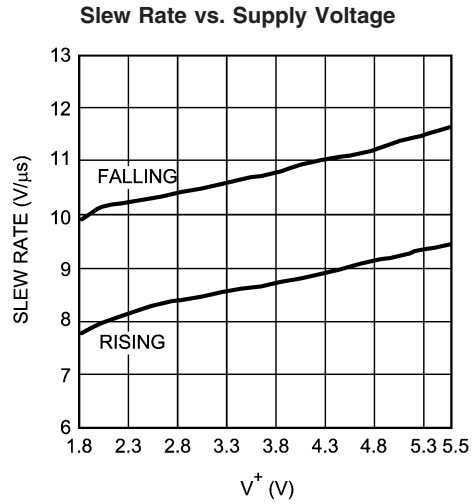

20116829

Supply Current vs. Enable Pin Voltage (LMV791)

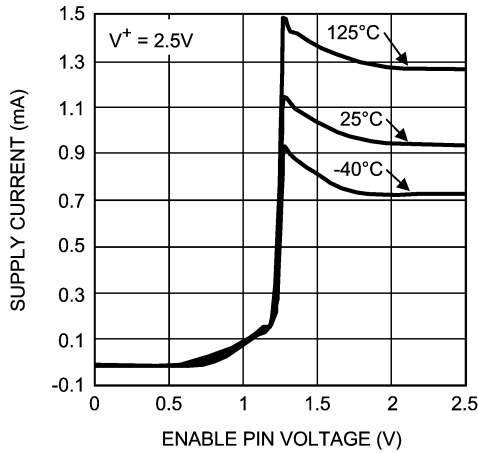

20116808

Supply Current vs. Enable Pin Voltage (LMV791)

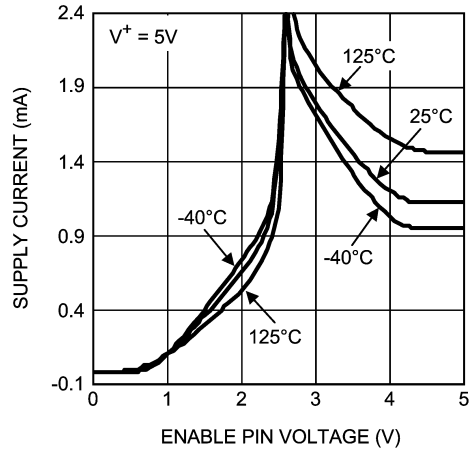

20116807

Supply Current vs. Enable Pin Voltage (LMV792)

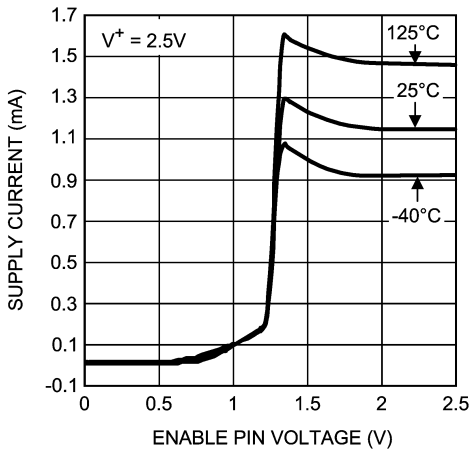

20116882

Supply Current vs. Enable Pin Voltage (LMV792)

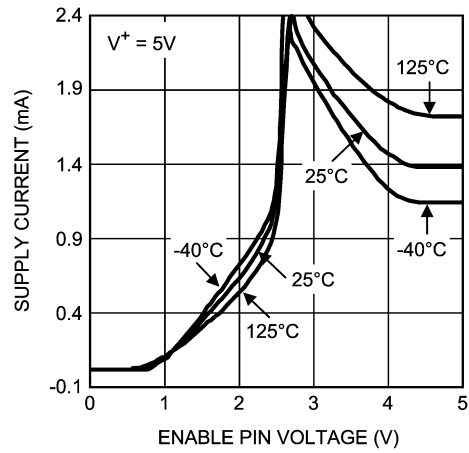

20116883

Typical Performance Characteristics Unless otherwise specified, $T_A = 25^\circ\text{C}$, $V^- = 0$, $V^+ = \text{Supply}$
 Voltage = 5V, $V_{CM} = V^+/2$, $V_{EN} = V^+$. (Continued)

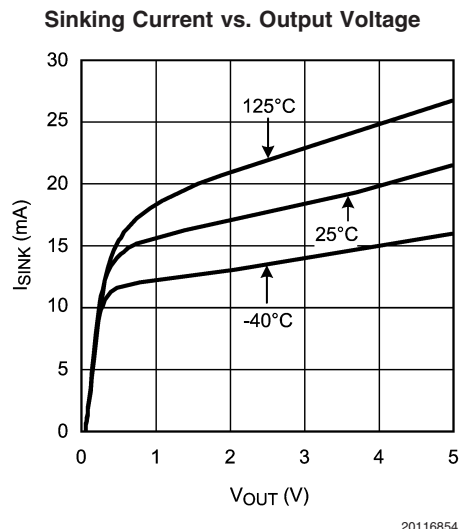
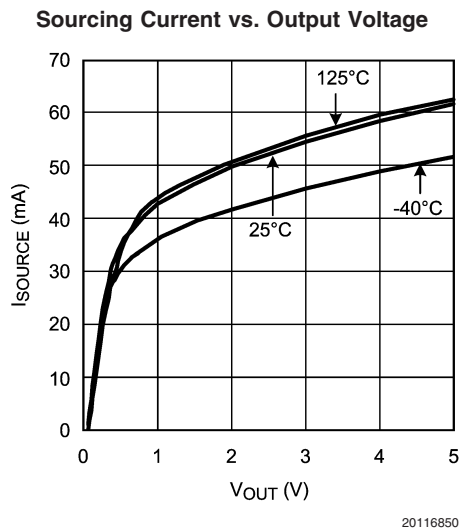
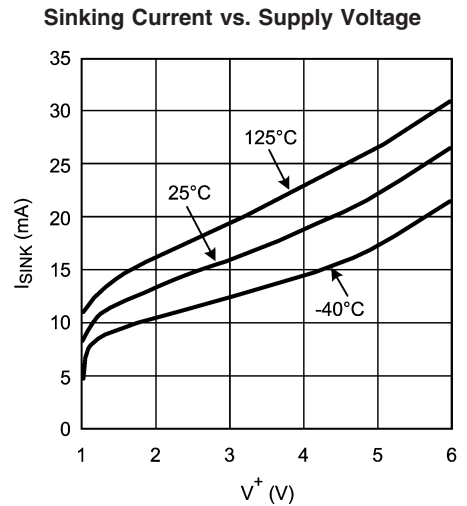
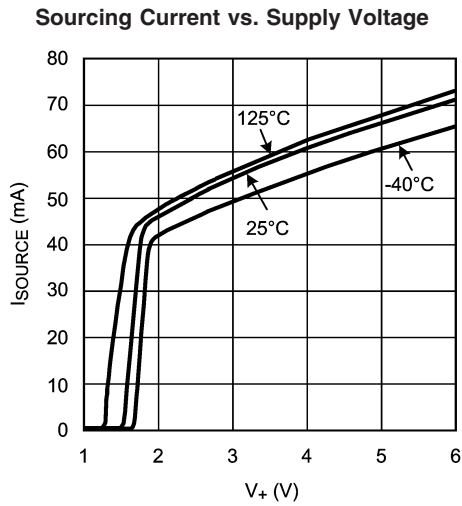
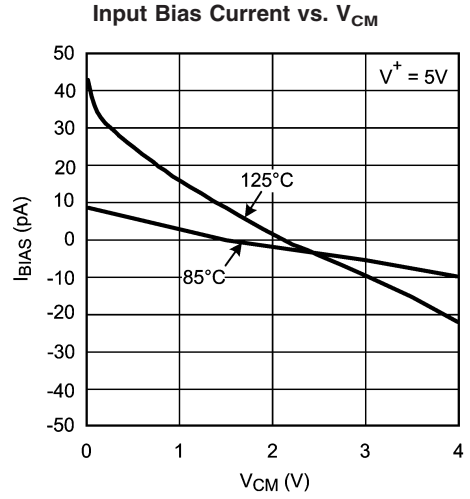
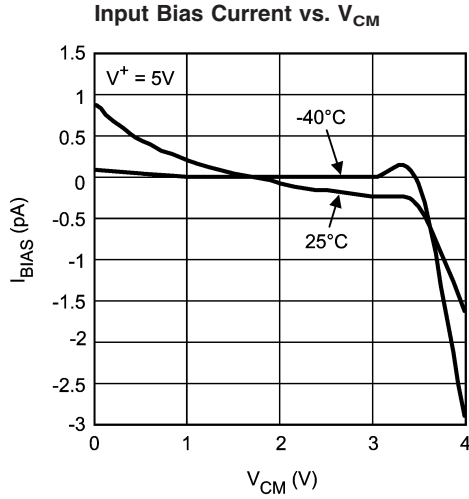

Typical Performance Characteristics Unless otherwise specified, $T_A = 25^\circ\text{C}$, $V^- = 0$, $V^+ = \text{Supply}$
 Voltage = 5V, $V_{CM} = V^+/2$, $V_{EN} = V^+$. (Continued)

Positive Output Swing vs. Supply Voltage

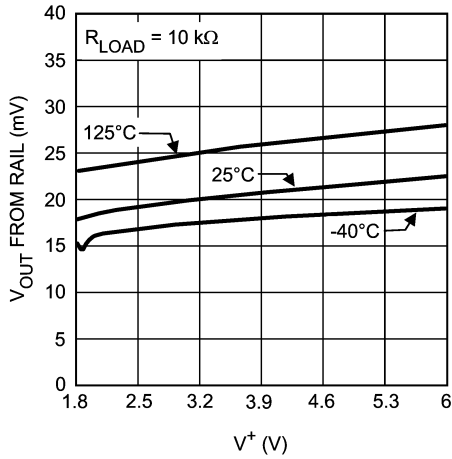

20116817

Negative Output Swing vs. Supply Voltage

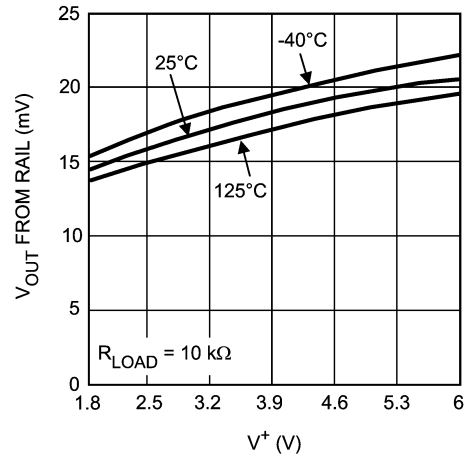

20116815

Positive Output Swing vs. Supply Voltage

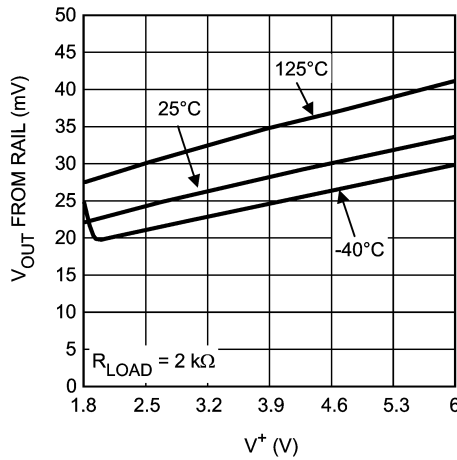

20116816

Negative Output Swing vs. Supply Voltage

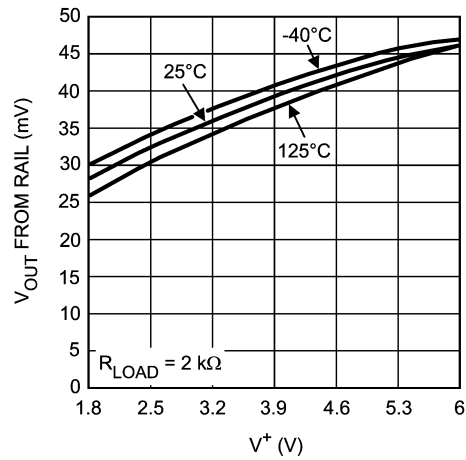

20116814

Positive Output Swing vs. Supply Voltage

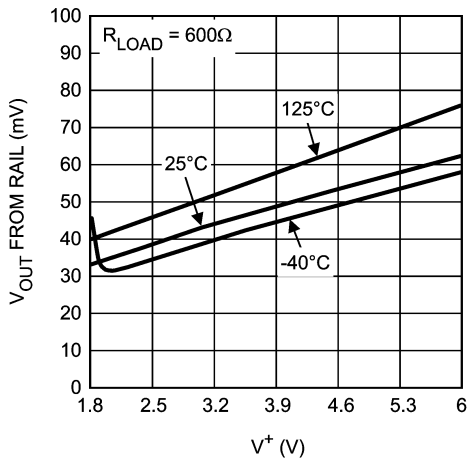

20116818

Negative Output Swing vs. Supply Voltage

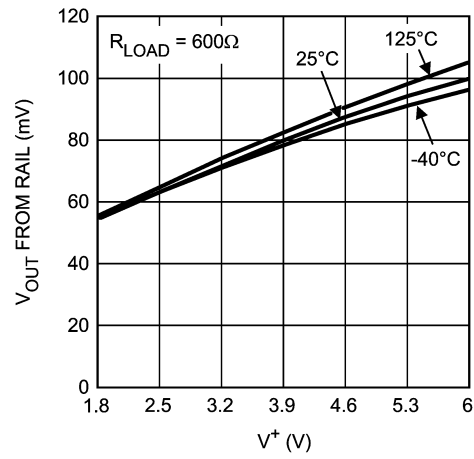

20116813

Typical Performance Characteristics Unless otherwise specified, $T_A = 25^\circ\text{C}$, $V^- = 0$, $V^+ = \text{Supply}$
 Voltage = 5V, $V_{CM} = V^+/2$, $V_{EN} = V^+$. (Continued)

Input Referred Voltage Noise vs. Frequency

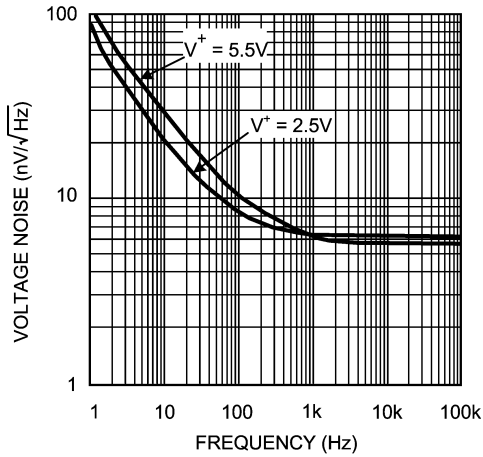

20116839

Overshoot and Undershoot vs. C_{LOAD}

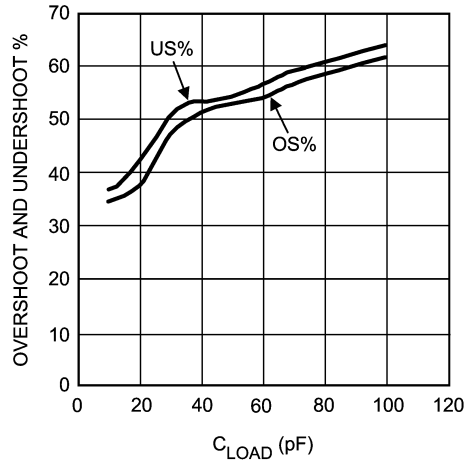

20116830

THD+N vs. Peak-to-Peak Output Voltage (V_{OUT})

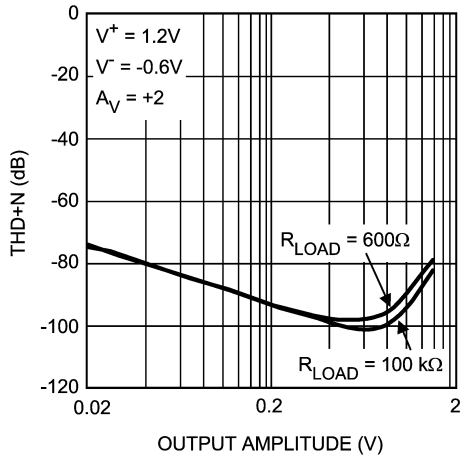

20116826

THD+N vs. Peak-to-Peak Output Voltage (V_{OUT})

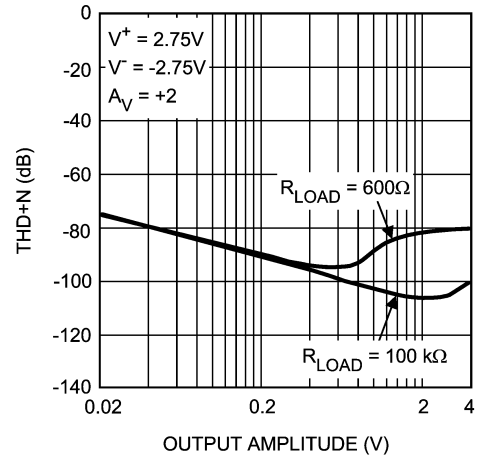

20116804

THD+N vs. Frequency

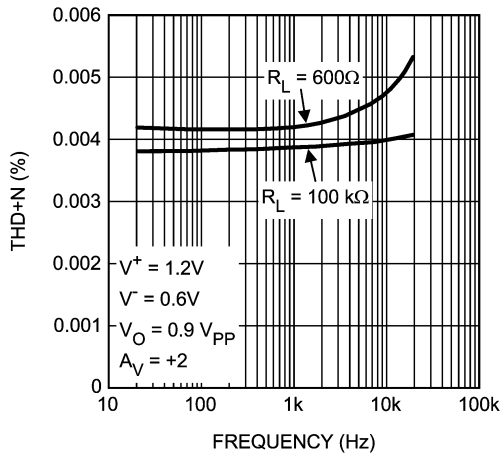

20116874

THD+N vs. Frequency

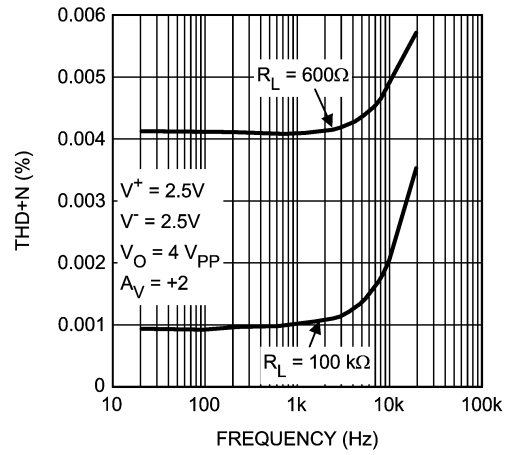

20116875

Typical Performance Characteristics Unless otherwise specified, $T_A = 25^\circ\text{C}$, $V^- = 0$, $V^+ = \text{Supply}$
 Voltage = 5V, $V_{CM} = V^+/2$, $V_{EN} = V^+$. (Continued)

Open Loop Gain and Phase with Capacitive Load

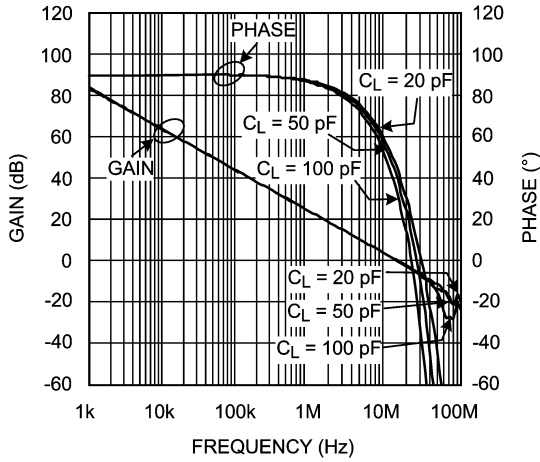

20116841

Open Loop Gain and Phase with Resistive Load

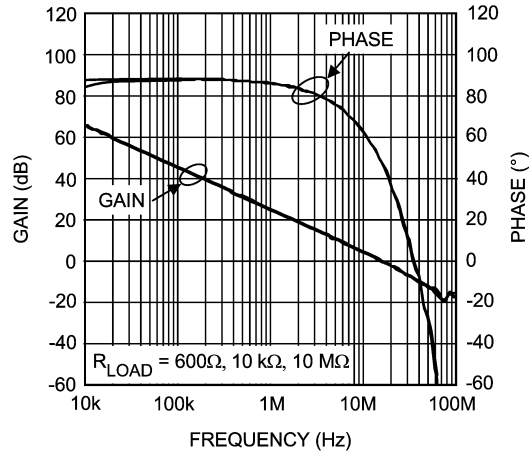

20116873

Closed Loop Output Impedance vs. Frequency

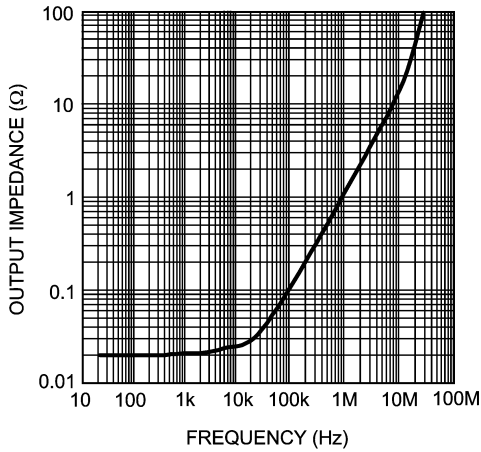

20116832

Crosstalk Rejection

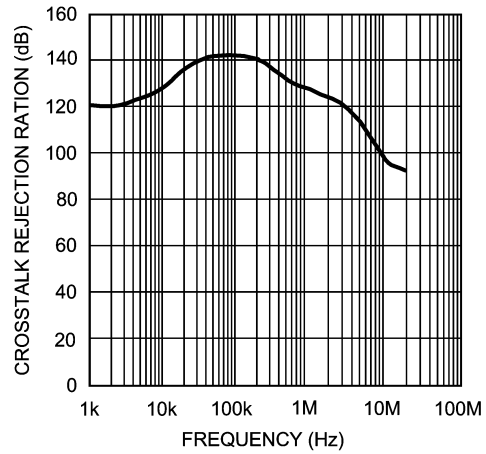

20116880

Small Signal Transient Response, $A_V = +1$

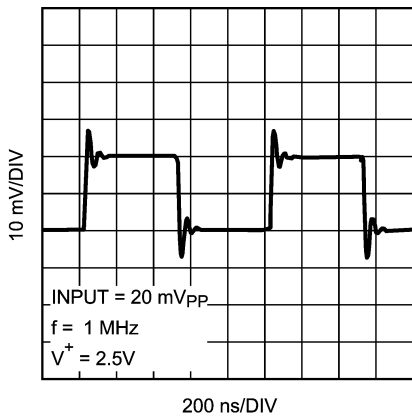

20116838

Large Signal Transient Response, $A_V = +1$

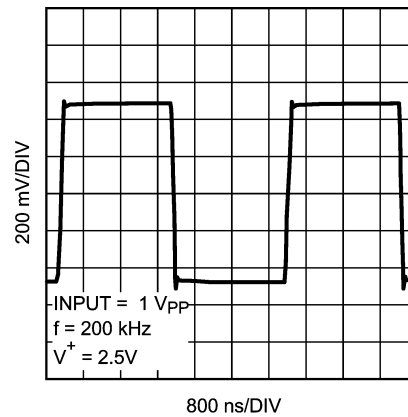

20116837

Typical Performance Characteristics Unless otherwise specified, $T_A = 25^\circ\text{C}$, $V^- = 0$, $V^+ = \text{Supply}$
 Voltage = 5V, $V_{CM} = V^+/2$, $V_{EN} = V^+$. (Continued)

Small Signal Transient Response, $A_V = +1$

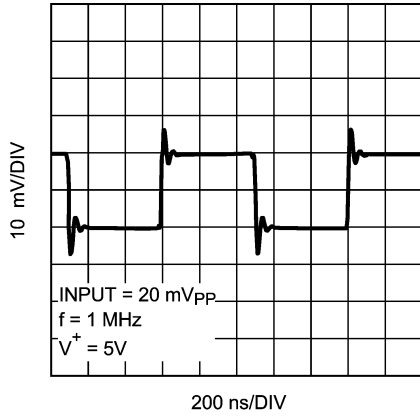

20116833

Large Signal Transient Response, $A_V = +1$

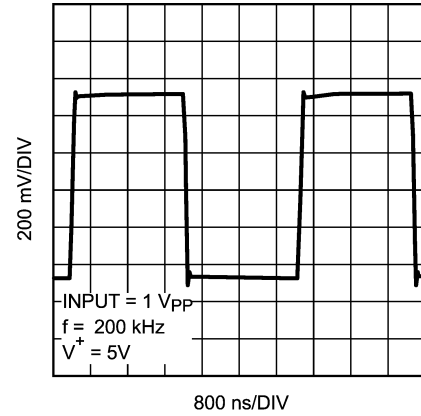

20116834

Phase Margin vs. Capacitive Load (Stability)

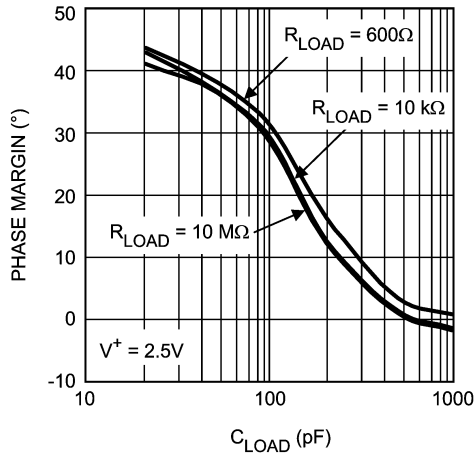

20116845

Phase Margin vs. Capacitive Load (Stability)

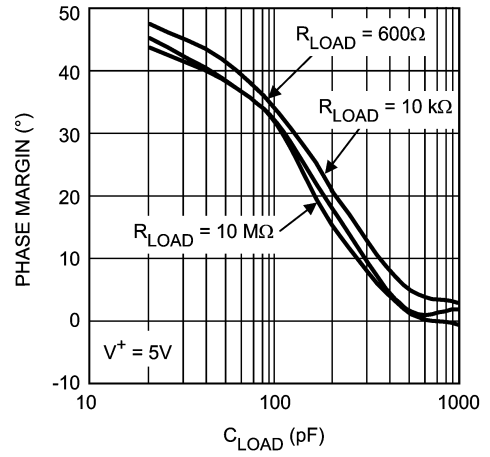

20116846

Positive PSRR vs. Frequency

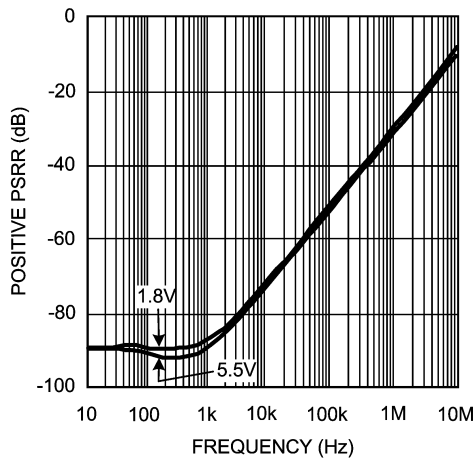

20116827

Negative PSRR vs. Frequency

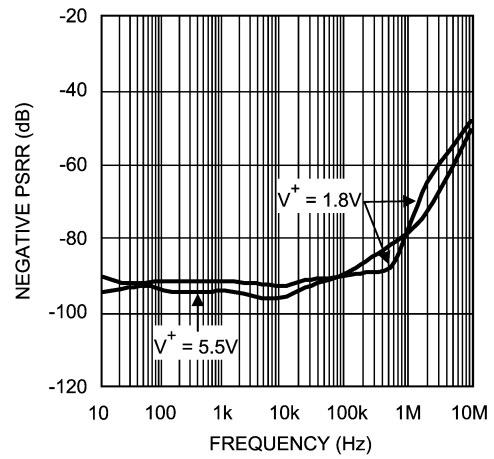

20116828

Typical Performance Characteristics Unless otherwise specified, $T_A = 25^\circ\text{C}$, $V^- = 0$, $V^+ = \text{Supply}$
 Voltage = 5V, $V_{CM} = V^+/2$, $V_{EN} = V^+$. (Continued)

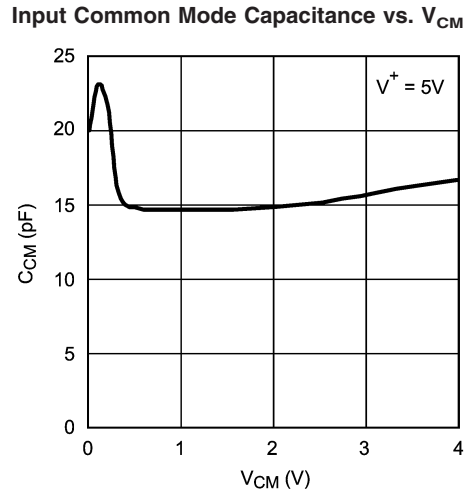
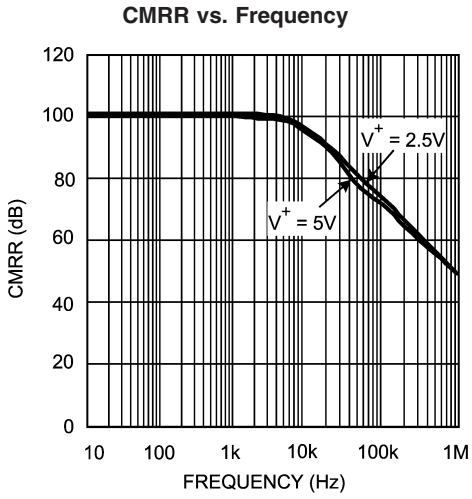

Application Notes

ADVANTAGES OF THE LMV791/LMV792

Wide Bandwidth at Low Supply Current

The LMV791 and LMV792 are high performance op amps that provide a unity gain bandwidth of 17 MHz while drawing a low supply current of 1.15 mA. This makes them ideal for providing wideband amplification in portable applications. The enable and shutdown feature can also be used to design more power efficient systems that offer wide bandwidth and high performance while consuming less average power.

Low Input Referred Noise and Low Input Bias Current

The LMV791/LMV792 have a very low input referred voltage noise density (5.8 nV/√Hz at 1 kHz). A CMOS input stage ensures a small input bias current (100 fA) and low input referred current noise (0.01 pA/√Hz). This is very helpful in maintaining signal fidelity, and makes the LMV791 and LMV792 ideal for audio and sensor based applications.

Low Supply Voltage

The LMV791 and the LMV792 have performance guaranteed at 2.5V and 5V supply. The LMV791 family is guaranteed to be operational at all supply voltages between 2.0V and 5.5V, for ambient temperatures ranging from -40°C to 125°C, thus utilizing the entire battery lifetime. The LMV791 and LMV792 are also guaranteed to be operational at 1.8V supply voltage, for temperatures between 0°C and 125°C. This makes the LMV791 family ideal for usage in low-voltage commercial applications.

RRO and Ground Sensing

Rail-to-rail output swing provides maximum possible dynamic range at the output. This is particularly important when operating at low supply voltages. An innovative positive feedback scheme is used to boost the current drive capability of the output stage. This allows the LMV791 and the LMV792 to source more than 40 mA of current at 1.8V supply. This also limits the performance of the LMV791 family as comparators, and hence the usage of the LMV791 and the LMV792 in an open-loop configuration is not recommended. The input common-mode range includes the negative supply rail which allows direct sensing at ground in single supply operation.

Enable and Shutdown Features

The LMV791 family is ideal for battery powered systems. With a low supply current of 1.15 mA and a shutdown current of 140 nA typically, the LMV791 and LMV792 allow the designer to maximize battery life. The enable pin of the LMV791 and the LMV792 allows the op amp to be turned off and reduce its supply current to less than 1 μA. To power on the op amp the enable pin should be higher than $V^+ - 0.5V$, where V^+ is the positive supply. To disable the op amp, the enable pin voltage should be less than $V^- + 0.5V$, where V^- is the negative supply.

Small Size

The small footprint of the LMV791 and the LMV792 package saves space on printed circuit boards, and enables the design of smaller electronic products, such as cellular phones, pagers, or other portable systems. Long traces between the signal source and the opamp make the signal path susceptible to noise. By using a physically smaller LMV791 and LMV792 package, the opamp can be placed closer to the signal source, reducing noise pickup and increasing signal integrity.

CAPACITIVE LOAD TOLERANCE

The LMV791 and LMV792 can directly drive 120 pF in unity-gain without oscillation. The unity-gain follower is the most sensitive configuration to capacitive loading. Direct capacitive loading reduces the phase margin of amplifiers. The combination of the amplifier's output impedance and the capacitive load induces phase lag. This results in either an underdamped pulse response or oscillation. To drive a heavier capacitive load, the circuit in *Figure 1* can be used. In *Figure 1*, the isolation resistor R_{ISO} and the load capacitor C_L form a pole to increase stability by adding more phase margin to the overall system. The desired performance depends on the value of R_{ISO} . The bigger the R_{ISO} resistor value, the more stable V_{OUT} will be. Increased R_{ISO} would, however, result in a reduced output swing and short circuit current.

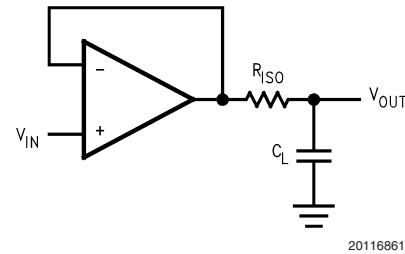
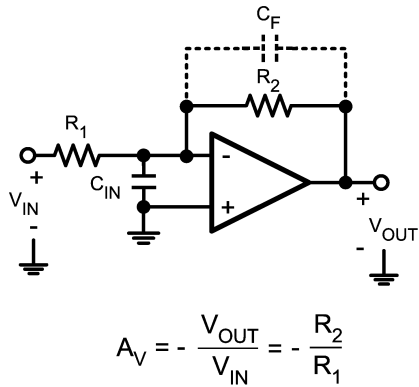

FIGURE 1. Isolation of C_L to Improve Stability

INPUT CAPACITANCE AND FEEDBACK CIRCUIT ELEMENTS

The LMV791 family has a very low input bias current (100 fA) and a low $1/f$ noise corner frequency (400 Hz), which makes it ideal for sensor applications. However, to obtain this performance a large CMOS input stage is used, which adds to the input capacitance of the op-amp, C_{IN} . Though this does not affect the DC and low frequency performance, at higher frequencies the input capacitance interacts with the input and the feedback impedances to create a pole, which results in lower phase margin and gain peaking. This can be controlled by being selective in the use of feedback resistors, as well as by using a feedback capacitance, C_F . For example, in the inverting amplifier shown in *Figure 2*, if C_{IN} and C_F are ignored and the open loop gain of the op amp is considered infinite then the gain of the circuit is $-R_2/R_1$. An op amp, however, usually has a dominant pole, which causes its gain to drop with frequency. Hence, this gain is only valid for DC and low frequency. To understand the effect of the input capacitance coupled with the non-ideal gain of the op amp, the circuit needs to be analyzed in the frequency domain using a Laplace transform.

Application Notes (Continued)



20116864

FIGURE 2. Inverting Amplifier

For simplicity, the op amp is modelled as an ideal integrator with a unity gain frequency of A_0 . Hence, its transfer function (or gain) in the frequency domain is A_0/s . Solving the circuit equations in the frequency domain, ignoring C_F for the moment, results in an expression for the gain shown in *Equation (1)*.

$$\frac{V_{OUT}}{V_{IN}}(s) = \frac{-R_2/R_1}{\left[1 + \frac{s}{\left(\frac{A_0 R_1}{R_1 + R_2} \right)} + \frac{s^2}{\left(\frac{A_0}{C_{IN} R_2} \right)} \right]} \quad (1)$$

It can be inferred from the denominator of the transfer function that it has two poles, whose expressions can be obtained by solving for the roots of the denominator and are shown in *Equation (2)*.

$$P_{1,2} = \frac{-1}{2C_{IN}} \left[\frac{1}{R_1} + \frac{1}{R_2} \pm \sqrt{\left(\frac{1}{R_1} + \frac{1}{R_2} \right)^2 - \frac{4 A_0 C_{IN}}{R_2}} \right] \quad (2)$$

Equation (2) shows that as the values of R_1 and R_2 are increased, the magnitude of the poles, and hence the bandwidth that the amplifier, is reduced. This theory is verified by using different values of R_1 and R_2 in the circuit shown in *Figure 1* and by comparing their frequency responses. In *Figure 3* the frequency responses for three different values of R_1 and R_2 are shown. When both R_1 and R_2 are 1 kΩ, the response is flattest and widest; whereas, it narrows and peaks significantly when both their values are changed to 10 kΩ or 30 kΩ. So it is advisable to use lower values of R_1

and R_2 to obtain a wider and flatter response. Lower resistances also help in high sensitivity circuits since they add less noise.

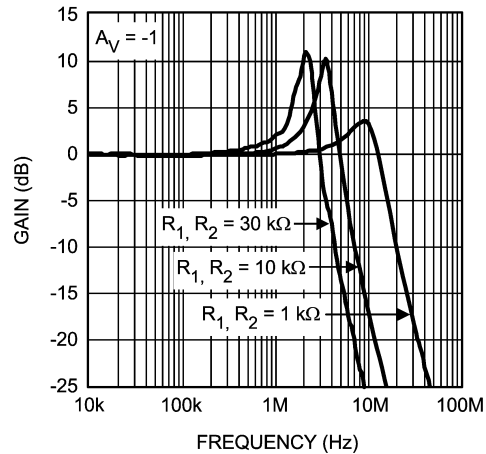

20116859

FIGURE 3. Gain Peaking Caused by Large R_1, R_2

A way of reducing the gain peaking is by adding a feedback capacitance C_F in parallel with R_2 . This introduces another pole in the system and prevents the formation of pairs of complex conjugate poles which cause the gain to peak. *Figure 4* shows the effect of C_F on the frequency response of the circuit. Adding a capacitance of 2 pF removes the peak, while a capacitance of 5 pF creates a much lower pole and reduces the bandwidth excessively.

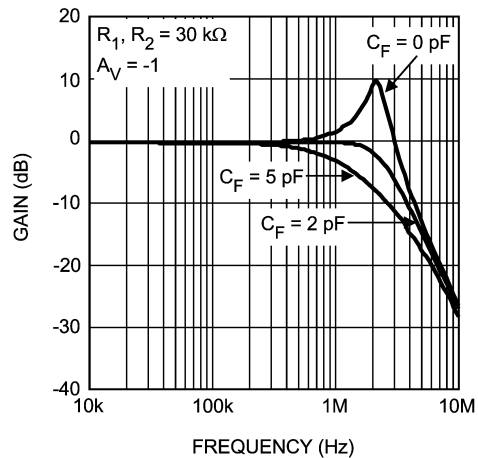

20116860

FIGURE 4. Gain Peaking Eliminated by C_F

Application Notes (Continued)

AUDIO PREAMPLIFIER WITH BANDPASS FILTERING

With low input referred voltage noise, low supply voltage and low supply current, and a low harmonic distortion, the LMV791 family is ideal for audio applications. Its wide unity gain bandwidth allows it to provide large gain for a wide range of frequencies and it can be used to design a preamplifier to drive a load of as low as 600Ω with less than 0.01% distortion. Two amplifier circuits are shown in *Figure 5* and *Figure 6*. *Figure 5* is an inverting amplifier, with a 10 kΩ feedback resistor, R₂, and a 1 kΩ input resistor, R₁, and hence provides a gain of -10. *Figure 6* is a non-inverting amplifier, using the same values of R₁ and R₂, and provides a gain of 11. In either of these circuits, the coupling capacitor C_{C1} decides the lower frequency at which the circuit starts providing gain, while the feedback capacitor C_F decides the frequency at which the gain starts dropping off. *Figure 7* shows the frequency response of the inverting amplifier with different values of C_F.

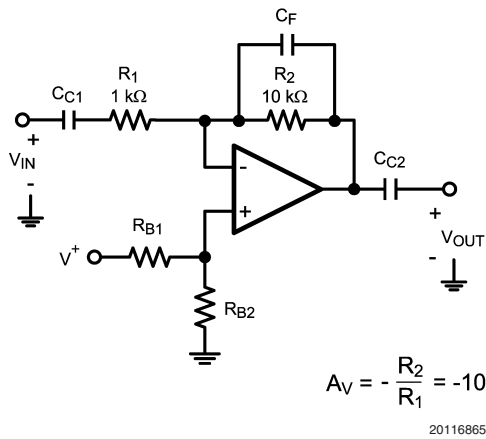

FIGURE 5. Inverting Audio Preamplifier

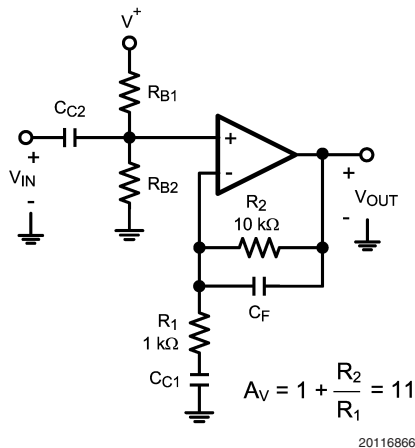

FIGURE 6. Non-inverting Audio Preamplifier

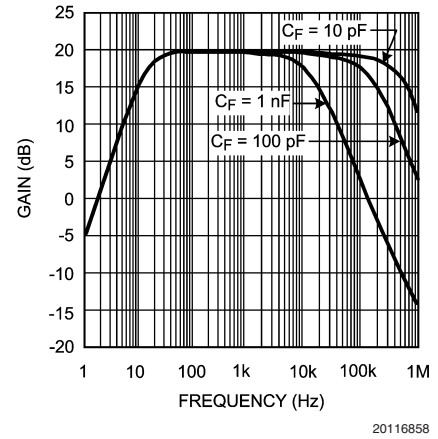

FIGURE 7. Frequency Response of the Inverting Audio Preamplifier

TRANSIMPEDANCE AMPLIFIER

CMOS input op amps are often used in transimpedance applications as they have an extremely high input impedance. A transimpedance amplifier converts a small input current into a voltage. This current is usually generated by a photodiode. The transimpedance gain, measured as the ratio of the output voltage to the input current, is expected to be large and wide-band. Since the circuit deals with currents in the range of a few nA, low noise performance is essential. The LMV791/LMV792 are CMOS input op amps providing wide bandwidth and low noise performance, and are hence ideal for transimpedance applications.

Usually, a transimpedance amplifier is designed on the basis of the current source driving the input. A photodiode is a very common capacitive current source, which requires transimpedance gain for transforming its miniscule current into easily detectable voltages. The photodiode and amplifier's gain are selected with respect to the speed and accuracy required of the circuit. A faster circuit would require a photodiode with lesser capacitance and a faster amplifier. A more sensitive circuit would require a sensitive photodiode and a high gain. A typical transimpedance amplifier is shown in *Figure 8*. The output voltage of the amplifier is given by the equation $V_{OUT} = -I_{IN}R_F$. Since the output swing of the amplifier is limited, R_F should be selected such that all possible values of I_{IN} can be detected.

The LMV791/LMV792 have a large gain-bandwidth product (17 MHz), which enables high gains at wide bandwidths. A rail-to-rail output swing at 5.5V supply allows detection and amplification of a wide range of input currents. A CMOS input stage with negligible input current noise and low input voltage noise allows the LMV791/LMV792 to provide high fidelity amplification for wide bandwidths. These properties make the LMV791/LMV792 ideal for systems requiring wide-band transimpedance amplification.

Application Notes (Continued)

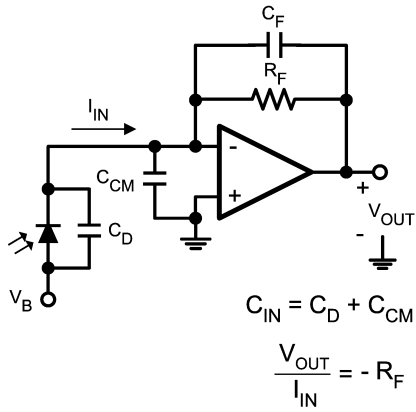

20116869

FIGURE 8. Photodiode Transimpedance Amplifier

As mentioned earlier, the following parameters are used to design a transimpedance amplifier: the amplifier gain-bandwidth product, A_0 ; the amplifier input capacitance, C_{CM} ; the photodiode capacitance, C_D ; the transimpedance gain required, R_F ; and the amplifier output swing. Once a feasible R_F is selected using the amplifier output swing, these numbers can be used to design an amplifier with the desired transimpedance gain and a maximally flat frequency response.

An essential component for obtaining a maximally flat response is the feedback capacitor, C_F . The capacitance seen at the input of the amplifier, C_{IN} , combined with the feedback capacitor, R_F , generate a phase lag which causes gain-peaking and can destabilize the circuit. C_{IN} is usually just the sum of C_D and C_{CM} . The feedback capacitor C_F creates a pole, f_P in the noise gain of the circuit, which neutralizes the zero in the noise gain, f_Z , created by the combination of R_F and C_{IN} . If properly positioned, the noise gain pole created by C_F can ensure that the slope of the gain remains at 20 dB/decade till the unity gain frequency of the amplifier is reached, thus ensuring stability. As shown in Figure 9, f_P is positioned such that it coincides with the point where the noise gain intersects the op amp's open loop gain. In this case, f_P is also the overall 3 dB frequency of the transimpedance amplifier. The value of C_F needed to make it so is given by Equation (3). A larger value of C_F causes excessive reduction of bandwidth, while a smaller value fails to prevent gain peaking and instability.

$$C_F = \frac{1 + \sqrt{1 + 4\pi R_F C_{IN} A_0}}{2\pi R_F A_0} \tag{3}$$

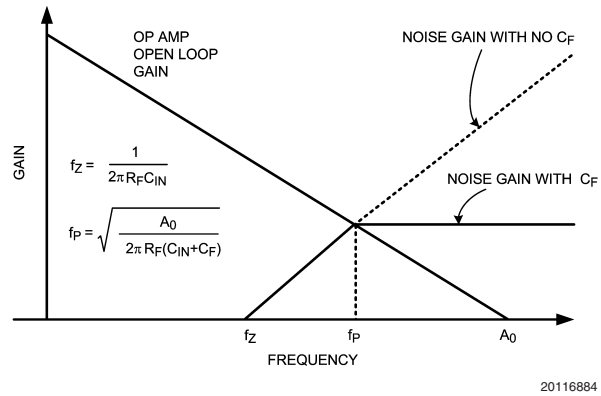

20116884

FIGURE 9. C_F Selection for Stability

Calculating C_F from Equation (3) can sometimes return unreasonably small values (<1 pF), especially for high speed applications. In these cases, its often more practical to use the circuit shown in Figure 10 in order to allow more reasonable values. In this circuit, the capacitance $C_{F'}$ is $(1 + R_B/R_A)$ time the effective feedback capacitance, C_F . A larger capacitor can now be used in this circuit to obtain a smaller effective capacitance.

For example, if a C_F of 0.5 pF is needed, while only a 5 pF capacitor is available, R_B and R_A can be selected such that $R_B/R_A = 9$. This would convert a $C_{F'}$ of 5 pF into a C_F of 0.5 pF. This relationship holds as long as $R_A << R_F$.

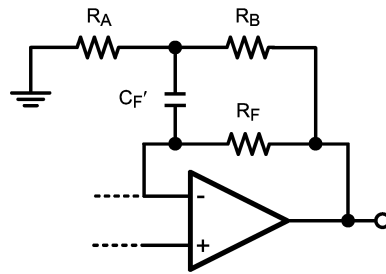

IF $R_A << R_F$

$$C_{F'} = \left(1 + \frac{R_B}{R_A}\right) C_F$$

20116871

FIGURE 10. Obtaining Small C_F from large $C_{F'}$

LMV791 AS A TRANSIMPEDANCE AMPLIFIER

The LMV791 was used to design a number of amplifiers with varying transimpedance gains and source capacitances. The gains, bandwidths and feedback capacitances of the circuits created are summarized in Table 1. The frequency responses are presented in Figure 11 and Figure 12. The feedback capacitances are slightly different from the formula in Equation (3), since the parasitic capacitance of the board and the feedback resistor R_F had to be accounted for.

Application Notes (Continued)

TABLE 1.

Transimpedance, A_{TI}	C_{IN}	C_F	3 dB Frequency
470000	50 pF	1.5 pF	350 kHz
470000	100 pF	2.0 pF	250 kHz
470000	200 pF	3.0 pF	150 kHz
47000	50 pF	4.5 pF	1.5 MHz
47000	100 pF	6.0 pF	1 MHz
47000	200 pF	9.0 pF	700 kHz

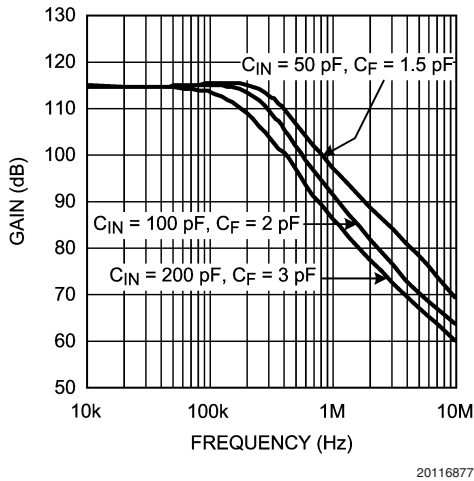

FIGURE 11. Frequency Response for $A_{TI} = 470000$

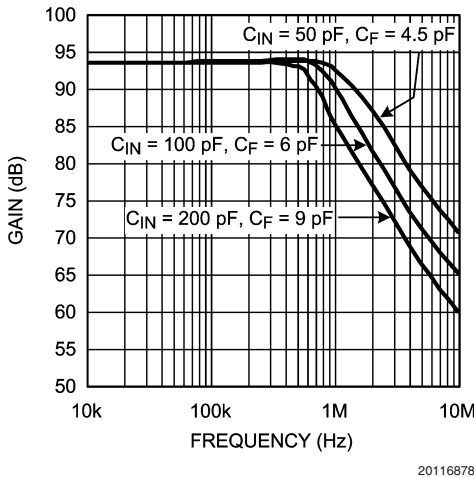
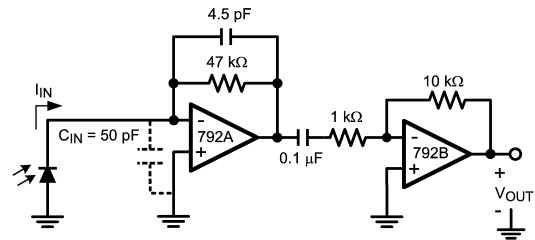

FIGURE 12. Frequency Response for $A_{TI} = 47000$

HIGH GAIN WIDEBAND TRANSIMPEDANCE AMPLIFIER USING THE LMV792

The LMV792, dual, low noise, wide bandwidth, CMOS input op amp IC can be used for compact, robust and integrated solutions for sensing and amplifying wide-band signals obtained from sensitive photodiodes. One of the two op amps available can be used to obtain transimpedance gain while the other can be used for amplifying the output voltage to further enhance the transimpedance gain. The wide bandwidth of the op amps (17 MHz) ensures that they are capable of providing high gain for a wide range of frequencies. The low input referred noise ($5.8 \text{ nV}/\sqrt{\text{Hz}}$) allows the amplifier to deliver an output with a high SNR (signal to noise ratio). The small MSOP-10 footprint saves space on printed circuit boards and allows ease of design in portable products.

The circuit shown in Figure 13, has the first op amp acting as a transimpedance amplifier with a gain of 47000, while the second stage provides a voltage gain of 10. This provides a total transimpedance gain of 470000 with a -3 dB bandwidth of about 1.5 MHz, for a total input capacitance of 50 pF. The frequency response for the circuit is shown in Figure 14



$$A_{TI} = \frac{V_{OUT}}{I_{IN}} = 470,000$$

20116886

FIGURE 13. 1.5 MHz Transimpedance Amplifier, with $A_{TI} = 470000$

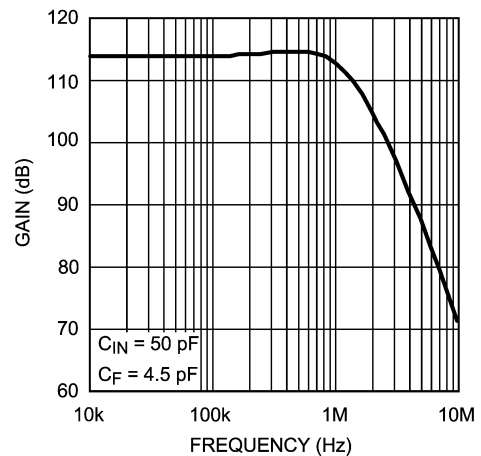

FIGURE 14. 1.5 MHz Transimpedance Amplifier Frequency Response

20116879

Application Notes (Continued)

SENSOR INTERFACES

The low input bias current and low input referred noise of the LMV791 and LMV792 make them ideal for sensor interfaces. These circuits are required to sense voltages of the order of a few μV , and currents amounting to less than a nA, and hence the op amp needs to have low voltage noise and low input bias current. Typical applications include infra-red (IR) thermometry, thermocouple amplifiers and pH electrode buffers. *Figure 15* is an example of a typical circuit used for measuring IR radiation intensity, often used for estimating the temperature of an object from a distance. The IR sensor generates a voltage proportional to I , which is the intensity of the IR radiation falling on it. As shown in *Figure 15*, K is the constant of proportionality relating the voltage across the IR sensor (V_{IN}) to the radiation intensity, I . The resistances R_A and R_B are selected to provide a high gain to amplify this voltage, while C_F is added to filter out the high frequency noise.

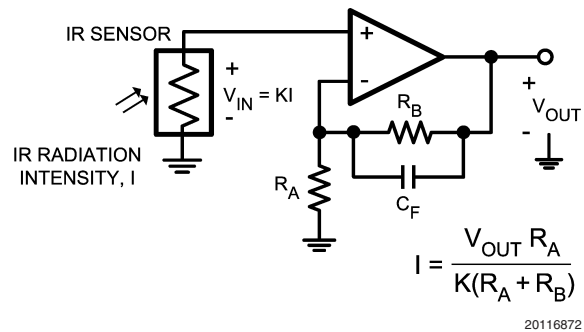
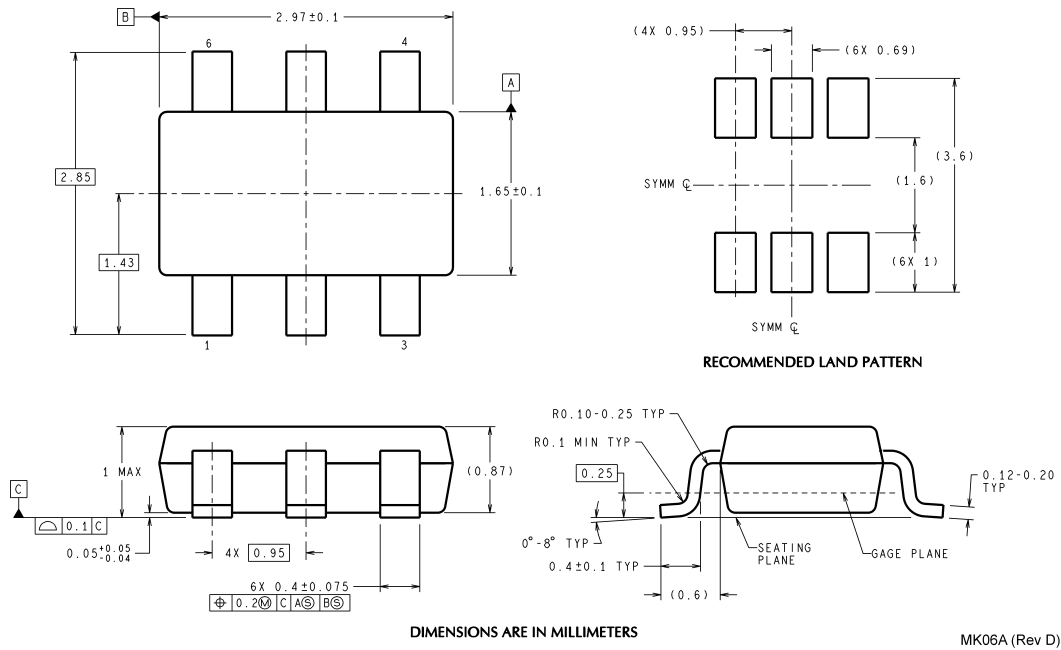
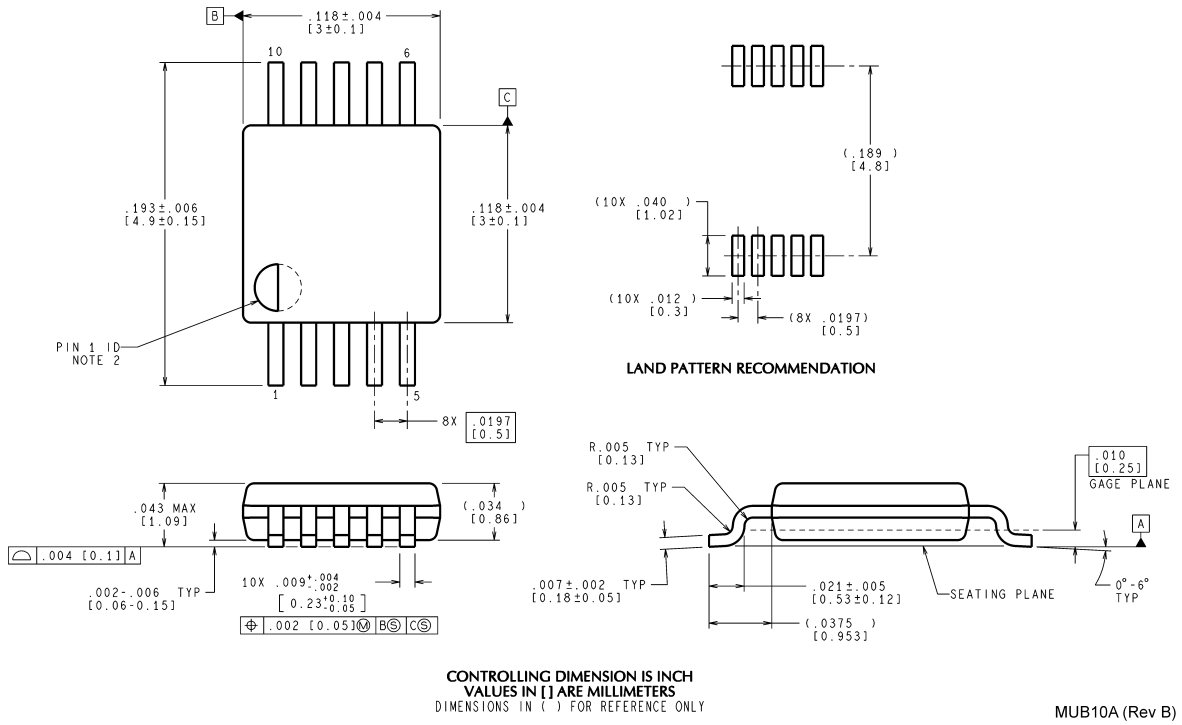

FIGURE 15. IR Radiation Sensor

Physical Dimensions inches (millimeters) unless otherwise noted



**6-Pin TSOT23
NS Package Number MK06A**



**10-Pin MSOP
NS package Number MUB10A**

Notes

National does not assume any responsibility for use of any circuitry described, no circuit patent licenses are implied and National reserves the right at any time without notice to change said circuitry and specifications.
 For the most current product information visit us at www.national.com.

LIFE SUPPORT POLICY

NATIONAL'S PRODUCTS ARE NOT AUTHORIZED FOR USE AS CRITICAL COMPONENTS IN LIFE SUPPORT DEVICES OR SYSTEMS WITHOUT THE EXPRESS WRITTEN APPROVAL OF THE PRESIDENT AND GENERAL COUNSEL OF NATIONAL SEMICONDUCTOR CORPORATION. As used herein:

- | | |
|--|---|
| <p>1. Life support devices or systems are devices or systems which, (a) are intended for surgical implant into the body, or (b) support or sustain life, and whose failure to perform when properly used in accordance with instructions for use provided in the labeling, can be reasonably expected to result in a significant injury to the user.</p> | <p>2. A critical component is any component of a life support device or system whose failure to perform can be reasonably expected to cause the failure of the life support device or system, or to affect its safety or effectiveness.</p> |
|--|---|

BANNED SUBSTANCE COMPLIANCE

National Semiconductor follows the provisions of the Product Stewardship Guide for Customers (CSP-9-111C2) and Banned Substances and Materials of Interest Specification (CSP-9-111S2) for regulatory environmental compliance. Details may be found at: www.national.com/quality/green.

Lead free products are RoHS compliant.



National Semiconductor
Americas Customer
Support Center
 Email: new.feedback@nsc.com
 Tel: 1-800-272-9959

National Semiconductor
Europe Customer Support Center
 Fax: +49 (0) 180-530 85 86
 Email: europe.support@nsc.com
 Deutsch Tel: +49 (0) 69 9508 6208
 English Tel: +44 (0) 870 24 0 2171
 Français Tel: +33 (0) 1 41 91 8790

National Semiconductor
Asia Pacific Customer
Support Center
 Email: ap.support@nsc.com

National Semiconductor
Japan Customer Support Center
 Fax: 81-3-5639-7507
 Email: jpn.feedback@nsc.com
 Tel: 81-3-5639-7560