



PRELIMINARY
June 1999

LMX2350/LMX2352 PLLatinum™ Fractional N RF / Integer N IF Dual Low Power Frequency Synthesizer

LMX2350 2.5 GHz/550 MHz
LMX2352 1.2 GHz/550 MHz

2352 family features very low current consumption; typically LMX2350 (2.5 GHz) 6.75 mA, LMX2352 (1.2 GHz) 5.00 mA at 3.0V. The LMX2350/2352 are available in a 24-pin TSSOP surface mount plastic package.

General Description

The LMX2350/2352 is part of a family of monolithic integrated fractional N/ Integer N frequency synthesizers designed to be used in a local oscillator subsystem for a radio transceiver. It is fabricated using National's 0.5µm ABiC V silicon BiCMOS process. The LMX2350/2352 contains dual modulus prescalers along with modulo 15 or 16 fractional compensation circuitry in the RF divider. A 16/17 or 32/33 prescale ratio can be selected for the LMX2350, and the LMX2352 provides 8/9 or 16/17 prescale ratios. The IF circuitry for both the LMX2350 and LMX2352 contains an 8/9 prescaler, and is fully programmable. Using a fractional N phase locked loop technique, the LMX2350/52 can generate very stable low noise control signals for UHF and VHF voltage controlled oscillators (VCO's).

For the RF PLL, a highly flexible 16 level programmable charge pump supplies output current magnitudes from 100µA to 1.6mA. Two uncommitted CMOS outputs can be used to provide external control signals, or configured to FastLock™ mode. Serial data is transferred into the LMX2350/2352 via a three wire interface (Data, LE, Clock). Supply voltage can range from 2.7 V to 5.5 V. The LMX2350/

Features

- 2.7 V to 5.5 V operation
- Low current consumption
LMX2350: $I_{cc} = 6.75\text{mA typ at }3\text{v}$
LMX2352: $I_{cc} = 5.00\text{mA typ at }3\text{v}$
- Programmable or logical power down mode
 $I_{cc} = 5\ \mu\text{A typ at }3\text{v}$
- Modulo 15 or 16 fractional RF N divider supports ratios of 1, 2, 3, 4, 5, 8, 15, or 16
- Programmable charge pump current levels
RF 100µA to 1.6mA in 100µA steps
IF 100µA or 800 µA
- Digital filtered lock detect

Applications

- Portable wireless communications (PCS/PCN, cordless)
- Dual mode cellular telephone systems
- Zero blind slot TDMA systems
- Spread spectrum communication systems (CDMA)
- Cable TV Tuners (CATV)

Block Diagram

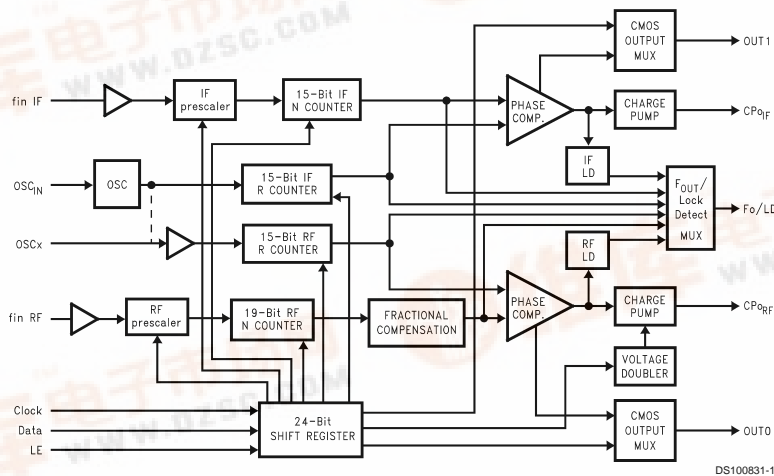

FastLock™ is a trademark of National Semiconductor Corporation.
MICROWIRE™ is a trademark of National Semiconductor Corporation.
PLLatinum™ is a trademark of National Semiconductor Corporation.
TRI-STATE® is a registered trademark of National Semiconductor Corporation.

LMX2350/LMX2352 PLLatinum™ Fractional N RF / Integer N IF Dual Low Power Frequency Synthesizer



Connection Diagram

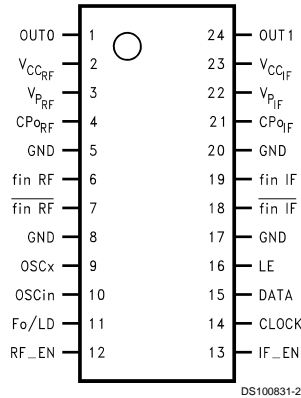

Order Number LMX2350TM or LMX2352TM
NS Package Number MTC24

Pin Descriptions

Pin No.	Pin Name	I/O	Description
1	OUT0	O	Programmable CMOS output. Level of the output is controlled by IF_N [17] bit.
2	V _{CCRF}	-	RF PLL power supply voltage input. Must be equal to V _{CCIF} . May range from 2.7 V to 5.5 V. Bypass capacitors should be placed as close as possible to this pin and be connected directly to the ground plane.
3	V _{PRF}	-	Power supply for RF charge pump. Must be $\geq V_{CCRF}$ and V _{CCIF} .
4	CP _{ORF}	O	RF charge pump output. Connected to a loop filter for driving the control input of an external VCO.
5	GND	-	Ground for RF PLL digital circuitry.
6	fin RF	I	RF prescaler input. Small signal input from the VCO.
7	fin RF	I	RF prescaler complimentary input. A bypass capacitor should be placed as close as possible to this pin and be connected directly to the ground plane.
8	GND	-	Ground for RF PLL analog circuitry.
9	OSCx	I/O	Dual mode oscillator output or RF R counter input. Has a V _{cc} /2 input threshold when configured as an input and can be driven from an external CMOS or TTL logic gate. Can also be configured as an output to work in conjunction with OSCin to form a crystal oscillator. (See functional description 1.1 and programming description 3.1.)
10	OSCin	I	Oscillator input which can be configured to drive both the IF and RF R counter inputs or only the IF R counter depending on the state of the OSC programming bit. (See functional description 1.1 and programming description 3.1.)
11	FoLD	O	Multiplexed output of N or R divider and RF/IF lock detect. Active High/Low CMOS output except in analog lock detect mode. (See programming description 3.1.5.)
12	RF_EN	I	RF PLL Enable. Powers down RF N and R counters, prescaler, and will TRI-STATE® the charge pump output when LOW. Bringing RF_EN high powers up RF PLL depending on the state of RF_CTL_WORD. (See functional description 1.9.)
13	IF_EN	I	IF PLL Enable. Powers down IF N and R counters, prescaler, and will TRI-STATE the charge pump output when LOW. Bringing IF_EN high powers up IF PLL depending on the state of IF_CTL_WORD. (See functional description 1.9.)
14	CLOCK	I	High impedance CMOS Clock input. Data for the various counters is clocked into the 24 - bit shift register on the rising edge.
15	DATA	I	Binary serial data input. Data entered MSB first. The last two bits are the control bits. High impedance CMOS input.
16	LE	I	Load enable high impedance CMOS input. Data stored in the shift registers is loaded into one of the 4 internal latches when LE goes HIGH. (See functional description 1.7.)

Connection Diagram (Continued)

Pin No.	Pin Name	I/O	Description
17	GND	-	Ground for IF analog circuitry.
18	$\overline{\text{fin}}_{\text{IF}}$	I	IF prescaler complimentary input. A bypass capacitor should be placed as close as possible to this pin and be connected directly to the ground plane.
19	fin _{IF}	I	IF prescaler input. Small signal input from the VCO.
20	GND	-	Ground for IF digital circuitry.
21	CP _{OIF}	O	IF charge pump output. For connection to a loop filter for driving the input of an external VCO.
22	V _{pIF}	-	Power supply for IF charge pump. Must be $\geq V_{\text{CCRF}}$ and V_{CCIF} .
23	V _{ccIF}	-	IF power supply voltage input. Must be equal to V_{CCRF} . Input may range from 2.7 V to 5.5 V. Bypass capacitors should be placed as close as possible to this pin and be connected directly to the ground plane.
24	OUT1	O	Programmable CMOS output. Level of the output is controlled by IF_N [18] bit.

Absolute Maximum Ratings (Note 1)

If Military/Aerospace specified devices are required, please contact the National Semiconductor Sales Office/Distributors for availability and specifications.

Parameter	Symbol	Value			Units
		Min	Typ	Max	
Power Supply Voltage	V _{CCRF}	-0.3		6.5	V
	V _{CCIF}	-0.3		6.5	V
	V _{PRF}	-0.3		6.5	V
	V _{PIF}	-0.3		6.5	V
Voltage on any pin with GND = 0 volts	V _i	-0.3		V _{CC} + 0.3	V
Storage Temperature Range	T _S	-65		+150	C°
Lead Temperature (Solder 4 sec.)	T _L			+260	C°
ESD - Whole Body Model (Note 2)			2		Kev

Recommended Operating Conditions

Parameter	Symbol	Value			Units
		Min	Typ	Max	
Power Supply Voltage	V _{CCRF}	2.7		5.5	V
	V _{CCIF}	V _{CCRF}		V _{CCRF}	V
	V _{PRF}	V _{CC}		5.5	V
	V _{PIF}	V _{CC}		5.5	V
Operating Temperature	T _A	-40		+ 85	C

Note 1: "Absolute Maximum Ratings" indicate limits beyond which damage to the device may occur. Operating Ratings indicate conditions for which the device is intended to be functional, but do not guarantee specific performance limits. For guaranteed specifications and test conditions, see the Electrical Characteristics. The guaranteed specifications apply only for the test conditions listed.

Note 2: This Device is a high performance RF integrated circuit and is ESD sensitive. Handling and assembly of this device should only be done at ESD-free workstations.

Electrical Characteristics (V_{CCRF} = V_{CCIF} = V_{PRF} = V_{PIF} = 3.0V; -40° C < T_A < 85° C except as specified)

Sym- bol	Parameter	Conditions	Min	Typ	Max	Units	
General							
I _{CC}	Power Supply Current	LMX2350	RF and IF, V _{CC} = 2.7V to 5.5V		6.75	7.75	mA
		LMX2352	RF and IF, V _{CC} = 2.7V to 5.5V		5.0	6.0	mA
		LMX2350/52	IF only, V _{CC} = 2.7V to 5.5V		1.25	1.45	mA
I _{CC-PWDN}	Power Down Current	RF_EN = IF_EN = LOW		5		µA	
f _{in} RF	RF Operating Frequency	LMX2350	Prescaler = 32 (Note 3)	1.2		2.5	GHz
			Prescaler = 16 (Note 3)	0.5		1.2	GHz
		LMX2352	Prescaler = 16 (Note 3)	0.5		1.2	GHz
			Prescaler = 8 (Note 3)	0.25		0.5	GHz
f _{in} IF	IF Operating Frequency		10		550	MHz	
f _{OSC}	Oscillator Frequency	No load on OSCx (Note 3)	2		50	MHz	
		With resonator load on OSCx (Note 3)	2		20	MHz	
f _φ	Phase Detector Frequency	RF and IF			10	MHz	
P _{f_{in} RF}	RF Input Sensitivity	V _{CC} = 3.0V	-15		0	dBm	
		V _{CC} = 5.0V	-10		0	dBm	
P _{f_{in} IF}	IF Input Sensitivity	2.7 V ≤ V _{CC} ≤ 5.5V	-10		0	dBm	
V _{OSC}	Oscillator Sensitivity	OSCin, OSCx	0.5		V _{CC}	V _{PP}	

Electrical Characteristics ($V_{CCRF} = V_{CCIF} = V_{PRF} = V_{PIF} = 3.0V$; $-40^{\circ}C < T_A < 85^{\circ}C$ except as specified)
(Continued)

Symbol	Parameter	Conditions	Min	Typ	Max	Units
Charge Pump						
ICPo _{-source} RF	RF Charge Pump Output Current (see Programming Description 3.2.2)	VCPo = Vp/2, RF_CP_WORD = 0000		-100		μA
ICPo _{-sink} RF		VCPo = Vp/2, RF_CP_WORD = 0000		100		μA
ICPo _{-source} RF		VCPo = Vp/2, RF_CP_WORD = 1111		-1.6		mA
ICPo _{-sink} RF		VCPo = Vp/2, RF_CP_WORD = 1111		1.6		mA
ICPo _{-source} IF	IF Charge Pump Output Current (see Programming Description 3.1.4)	VCPo = Vp/2, CP_GAIN_8 = 0		-100		μA
ICPo _{-sink} IF		VCPo = Vp/2, CP_GAIN_8 = 0		100		μA
ICPo _{-source} IF		VCPo = Vp/2, CP_GAIN_8 = 1		-800		μA
ICPo _{-sink} IF		VCPo = Vp/2, CP_GAIN_8 = 1		800		μA
ICPo _{-Tri}	Charge Pump TRI-STATE Current	$0.5 \leq VCPo \leq Vp - 0.5$ $-40^{\circ}C < T_A < 85^{\circ}C$	-2.5		2.5	nA
ICPo _{-sink} vs. ICPo _{-source}	CP Sink vs. Source Mismatch	VCPo = Vp/2 $T_A = 25^{\circ}C$		3	10	%
ICPo vs. VCPo	CP Current vs. Voltage	$0.5 \leq VCPo \leq Vp - 0.5$ $T_A = 25^{\circ}C$		8	15	%
ICPo vs. T	CP Current vs Temperature	VCPo = Vp/2 $-40^{\circ}C < T_A < 85^{\circ}C$		8		%
Digital Interface						
V _{IH}	High-level Input Voltage	(Note 4)	0.8 V _{CC}			V
V _{IL}	Low-level Input Voltage	(Note 4)			0.2 V _{CC}	V
I _{IH}	High-level Input Current	V _{IH} = V _{CC} = 5.5 V, (Note 4)	-1.0		1.0	μA
I _{IL}	Low-level Input Current	V _{IL} = 0, V _{CC} = 5.5 V, (Note 4)	-1.0		1.0	μA
I _{IH}	Oscillator Input Current	V _{IH} = V _{CC} = 5.5 V			100	μA
I _{IL}	Oscillator Input Current	V _{IL} = 0, V _{CC} = 5.5 V	-100			μA
V _{OH}	High-level Output Voltage	I _{OH} = -500 μA	V _{CC} - 0.4			V
V _{OL}	High-level Output Voltage	I _{OL} = 500 μA			0.4	V
MICROWIRE Timing						
t _{CS}	Data to Clock Setup Time	See Data Input Timing	50			ns
t _{CH}	Data to Clock Hold Time	See Data Input Timing	10			ns
t _{CWH}	Clock Pulse Width High	See Data Input Timing	50			ns
t _{CWL}	Clock Pulse Width Low	See Data Input Timing	50			ns
t _{ES}	Clock to Load Enable Set Up Time	See Data Input Timing	50			ns
t _{EW}	Load Enable Pulse Width	See Data Input Timing	50			ns
<p>Note 3: Minimum operating frequencies are not production tested - only characterized.</p> <p>Note 4: except fin, OSCin and OSCx</p>						

Charge Pump Current Specification Definitions

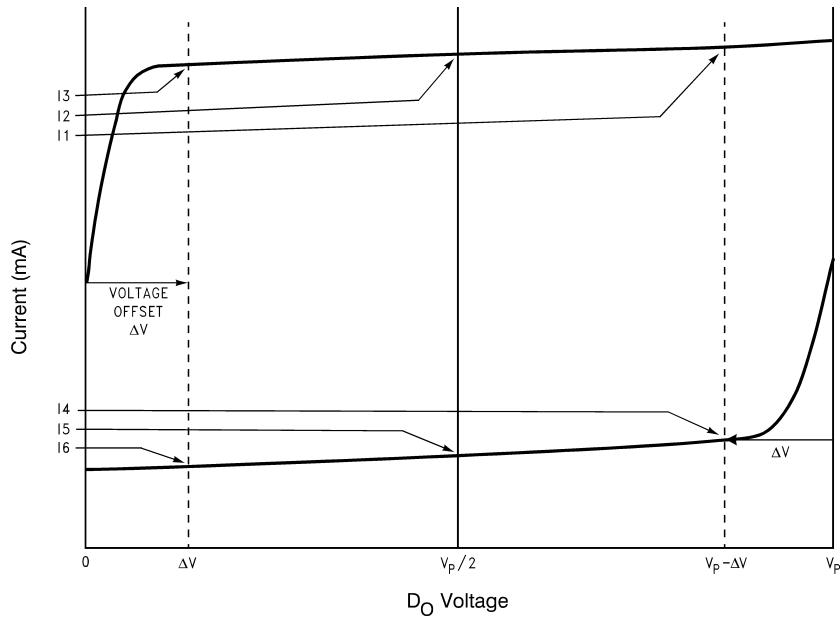

DS100831-7

- I1 = CP sink current at $V_{D_o} = V_p - \Delta V$
- I2 = CP sink current at $V_{D_o} = V_p/2$
- I3 = CP sink current at $V_{D_o} = \Delta V$
- I4 = CP source current at $V_{D_o} = V_p - \Delta V$
- I5 = CP source current at $V_{D_o} = V_p/2$
- I6 = CP source current at $V_{D_o} = \Delta V$

ΔV = Voltage offset from positive and negative rails. Dependent on VCO tuning range relative to V_{CC} and ground. Typical values are between 0.5V and 1.0V.

Note 5: I_{D_o} vs V_{D_o} = Charge Pump Output Current magnitude variation vs Voltage = $[\frac{1}{2} * (|I1| - |I3|)] / [\frac{1}{2} * (|I1| + |I3|)] * 100\%$ and $[\frac{1}{2} * (|I4| - |I6|)] / [\frac{1}{2} * (|I4| + |I6|)] * 100\%$

Note 6: I_{D_o-sink} vs $V_{D_o-source}$ = Charge Pump Output Current Sink vs Source Mismatch = $(|I2| - |I5|) / [\frac{1}{2} * (|I2| + |I5|)] * 100\%$

Note 7: I_{D_o} vs T_A = Charge Pump Output Current magnitude variation vs Temperature = $(|I2 @ temp| - |I2 @ 25^\circ C|) / |I2 @ 25^\circ C| * 100\%$ and $(|I5 @ temp| - |I5 @ 25^\circ C|) / |I5 @ 25^\circ C| * 100\%$

RF Sensitivity Test Block Diagram

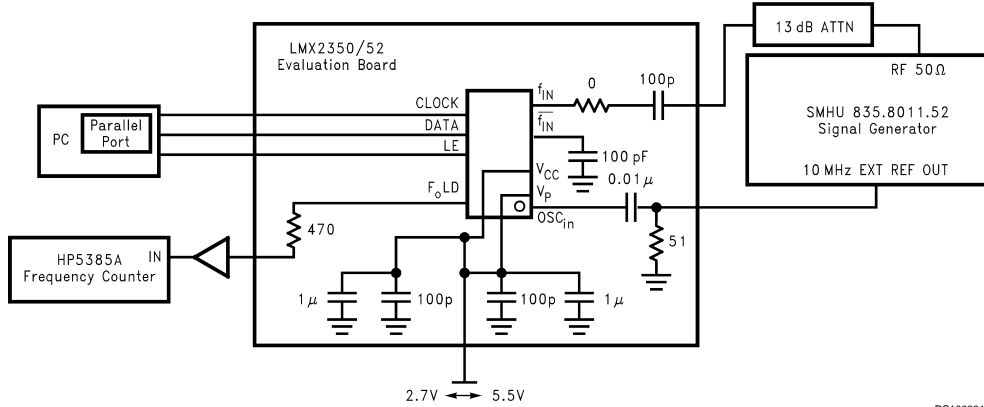

DS100831-8

Note: N = 10,000 R = 50 P = 64

Note: Sensitivity limit is reached when the error of the divided RF output, F_oLD, is ≥ 1 Hz.

Typical Performance Characteristics

I_{CC} vs V_{CC}
LMX2350

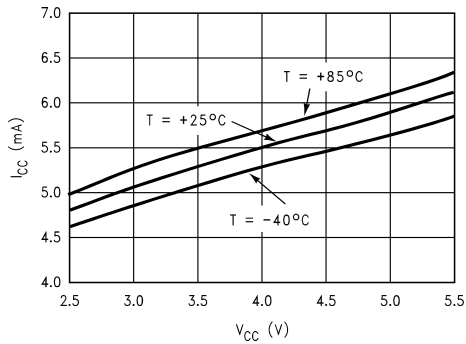

DS100831-9

I_{CC} vs V_{CC}
LMX2352

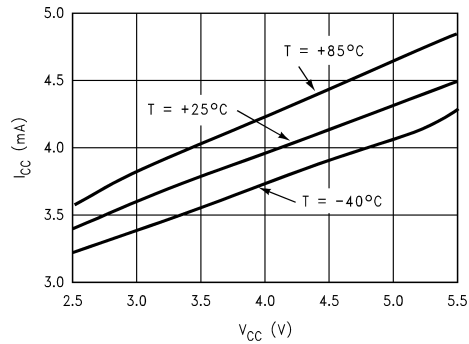

DS100831-10

I_{CP0} TRI-STATE vs
CP_O Voltage

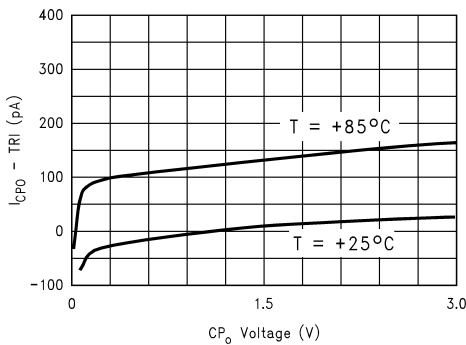

DS100831-11

Charge Pump Current vs CP_O Voltage
RF_CP_WORD = 0000 and 0111
IF CP_GAIN8 = 0 and 1

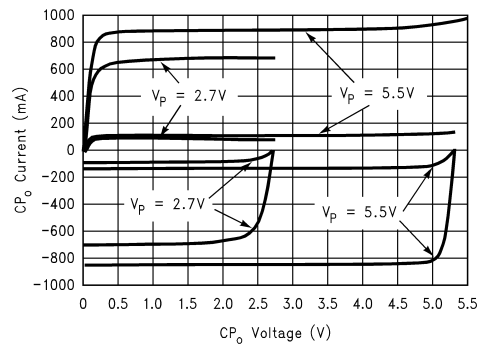

DS100831-12

Typical Performance Characteristics (Continued)

Charge Pump Current vs CP_o Voltage
RF_CP_WORD = 0011 and 1111

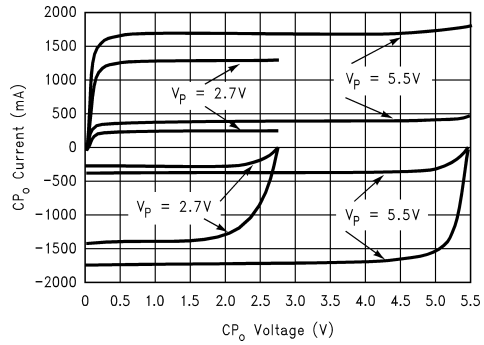

DS100831-13

Sink vs Source Mismatch
(See (Note 6) under Charge Pump Current Specification Definitions)

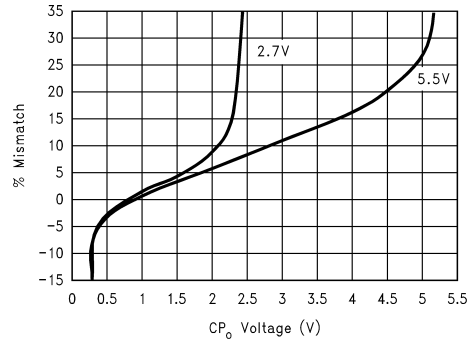

DS100831-14

RF Input Impedance
V_{CC} = 2.7V to 5.5V, f_{IN} = 50 MHz to 3 GHz (f_{IN} Capacitor = 100 pF)

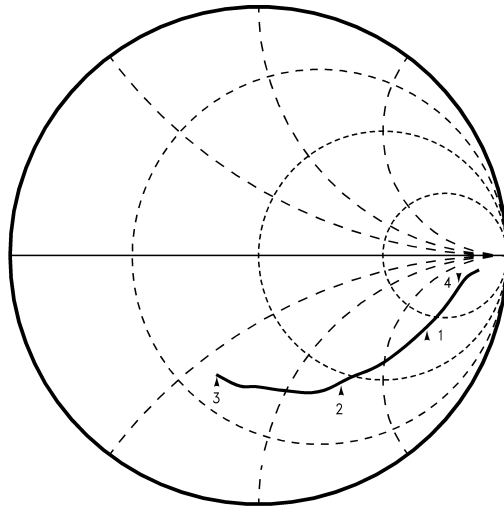

Marker 1 = 1 GHz, Real = 130, Imaginary = -153
Marker 2 = 2 GHz, Real = 44, Imaginary = -73
Marker 3 = 3 GHz, Real = 25, Imaginary = -32
Marker 4 = 500 MHz, Real = 246, Imaginary = -203

DS100831-15

IF Input Impedance
V_{CC} = 2.7V to 5.5V, f_{IN} = 10 MHz to 1 GHz (f_{IN} Capacitor = 100 pF)

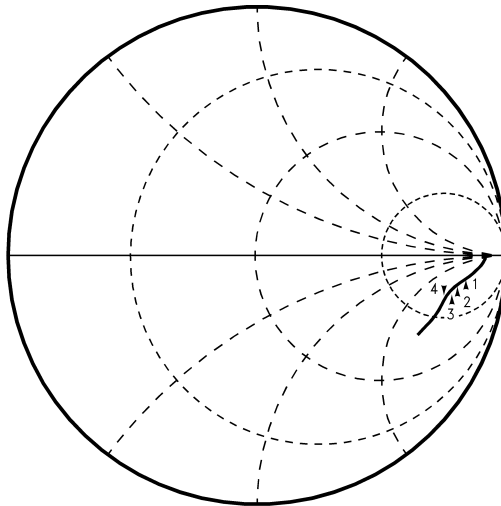

Marker 1 = 100 MHz, Real = 461, Imaginary = -272
Marker 2 = 200 MHz, Real = 357, Imaginary = -238
Marker 3 = 300 MHz, Real = 290, Imaginary = -226
Marker 4 = 500 MHz, Real = 213, Imaginary = -191

DS100831-16

Typical Performance Characteristics (Continued)

LMX2350 RF Sensitivity vs Frequency

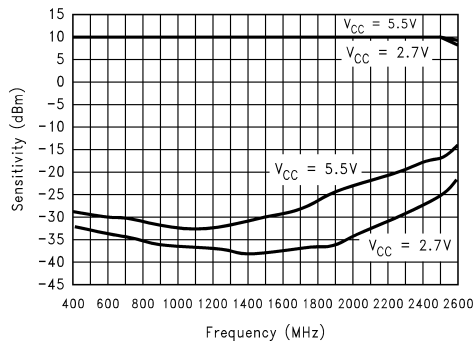

DS100831-17

LMX2352 RF Sensitivity vs Frequency

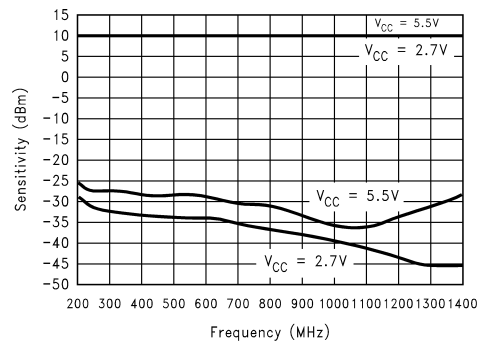

DS100831-18

IF Input Sensitivity vs Frequency

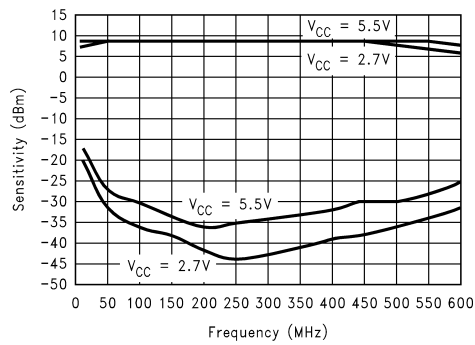

DS100831-19

Oscillator Input Sensitivity vs Frequency

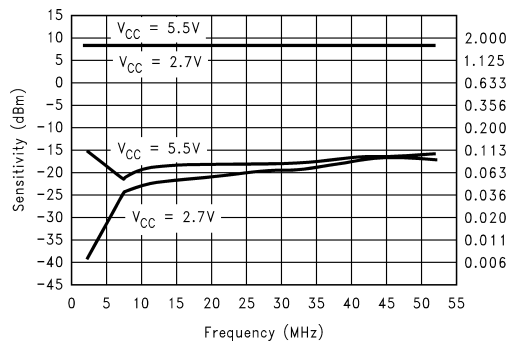

DS100831-20

LMX2350 V_p Voltage vs V_p Load Current in Vdoubler Mode, $T = 25^\circ C$

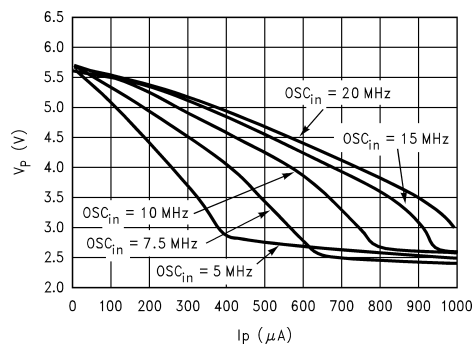

DS100831-21

Functional Description

1.0 General

The basic phase-lock-loop (PLL) configuration consists of a high-stability crystal reference oscillator, a frequency synthesizer such as the National Semiconductor LMX2350/52, a voltage controlled oscillator (VCO), and a passive loop filter. The frequency synthesizer includes a phase detector, current mode charge pump, as well as programmable reference [R] and feedback [N] frequency dividers. The VCO frequency is established by dividing the crystal reference signal down via the R counter to obtain a frequency that sets the comparison frequency. This reference signal, f_r , is then presented to the input of a phase/frequency detector and compared with another signal, f_p , the feedback signal, which was obtained by dividing the VCO frequency down by way of the N counter and fractional circuitry. The phase/frequency detector's current source outputs pump charge into the loop filter, which then converts the charge into the VCO's control voltage. The phase/frequency comparator's function is to adjust the voltage presented to the VCO until the feedback signal's frequency (and phase) match that of the reference signal. When this 'phase-locked' condition exists, the RF VCO's frequency will be $N+F$ times that of the comparison frequency, where N is the integer divide ratio and F is the fractional component. The fractional synthesis allows the phase detector frequency to be increased while maintaining the same frequency step size for channel selection. The division value N is thereby reduced giving a lower phase noise referred to the phase detector input, and the comparison frequency is increased allowing faster switching times.

1.1 Reference Oscillator Inputs

The reference oscillator frequency for the RF and IF PLL's is provided by either an external reference through the OSCin pin and OSCx pin, or an external crystal resonator across the OSCin and OSCx pins. OSCin/OSCx block can operate to 50MHz with an input sensitivity of 0.5Vpp. The OSC bit (see programming description 3.1.1), selects whether the oscillator input pins OSCin and OSCx drive the IF and RF R counters separately (Low) or by a common input signal path (Hi). The common OSC mode allows the user to form a local crystal oscillator circuit or drive the OSCin pin from an external signal source. When a crystal resonator is connected between OSCin and OSCx along with 2 external capacitors to form a crystal oscillator both reference chains are driven simultaneously. When a TCXO is connected only at the OSCin input pin and not at the OSCx pin, the TCXO drives both IF R counter and RF R counter. When configured as separate inputs, the OSCin pin drives the IF R counter while the OSCx drives the RF R counter. The inputs have a $V_{cc}/2$ input threshold and can be driven from an external CMOS or TTL logic gate.

1.2 Reference Dividers (R Counters)

The RF and IF R Counters are clocked through the oscillator block either separately or in common. The maximum frequency is 50MHz. Both R Counters are 15 bit CMOS counters with a divide range from 3 to 32,767. (See programming description 3.1.3.)

1.3 Programmable Dividers (N Counters)

The RF and IF N Counters are clocked by the small signal f_{in} RF and f_{in} IF input pins respectively. The LMX2350 RF N counter is 19 bits with 15 bits integer divide and 4 bits fractional. The integer part is configured as a 5 bit A Counter and

a 10 bit B Counter. The LMX2350 is capable of operating from 500 MHz to 1.2 GHz with the 16/17 prescaler offering a continuous integer divide range from 272 to 16399, and 1.2 GHz to 2.5 GHz with the 32/33 prescaler offering a continuous integer divide range from 1056 to 32767. The LMX2352 RF N counter is 18 bits with 14 bits integer divide and 4 bits fractional. The integer part is configured as a 4 bit A Counter and a 10 bit B Counter. The LMX2352 is capable of operating from 250 MHz to 500 MHz with the 8/9 prescaler offering a continuous integer divide range from 72 to 8199, and 500MHz to 1.2 GHz with 16/17 prescaler offering a continuous integer divide range from 272 to 16383. The RF counters for the LMX2350 family also contain fractional compensation, programmable in either 1/15 or 1/16 modes. Both LMX2350 and LMX2352 IF N counters are 15 bit integer dividers configured with a 3 bit A Counter and a 12 bit B Counter offering a continuous integer divide range from 56 to 32,767 over the frequency range of 10 MHz to 550 MHz. The IF N counters do not include fractional compensation.

1.3.1 Prescaler

The RF and IF inputs to the prescaler consist of f_{in} and f_{in} ; which are complimentary inputs to differential pair amplifiers. The complimentary inputs are internally coupled to ground with a 10 pF capacitor. These inputs are typically AC coupled to ground through external capacitors as well. The input buffer drives the A counter's ECL D-type flip flops in a dual modulus configuration. A 16/17 or 32/33 prescale ratio can be selected for the LMX2350, and the lower frequency LMX2352 provides 8/9 or 16/17 prescale ratios. The IF circuitry for both the LMX2350 and LMX2352 contain an 8/9 prescaler. The prescaler clocks the subsequent CMOS flip-flop chain comprising the fully programmable A and B counters.

1.3.2 Fractional Compensation

The fractional compensation circuitry of the LMX2350 and LMX2352 RF dividers allow the user to adjust the VCO's tuning resolution in 1/16 or 1/15 increments of the phase detector comparison frequency. A 4 bit register is programmed with the fractions desired numerator, while another bit selects between fractional 15 and 16 modulo base denominator (see programming description 4.2.4). An integer average is accomplished by using a 4 bit accumulator. A variable phase delay stage compensates for the accumulated integer phase error, minimizing the charge pump duty cycle, and reducing spurious levels. This technique eliminates the need for compensation current injection in to the loop filter. Overflow signals generated by the accumulator are equivalent to 1 full VCO cycle, and result in a pulse swallow.

1.4 Phase/Frequency Detector

The RF and IF phase/(frequency) detectors are driven from their respective N and R counter outputs. The maximum frequency at the phase detector inputs is about 2 MHz for some high frequency VCO due to the minimum continuous divide ratio of the dual modulus prescaler (i.e. If the VCO output frequency is 2.4816 GHz, the maximum phase detector input frequency is 2.35 MHz because the minimum continuous divide ratio of the LMX2350 with 32/33 prescaler is 1056). The phase detector outputs control the charge pumps. The polarity of the pump-up or pump-down control is programmed using RF_PD_POL or IF_PD_POL depending on whether RF/IF VCO characteristics are positive or negative (see programming descriptions 3.1.4 and 3.2.2). The phase detector also receives a feedback signal from the charge pump, in order to eliminate dead zone.

Functional Description (Continued)

1.5 Charge Pump

The phase detector's current source outputs pump charge into an external loop filter, which then converts the charge into the VCO's control voltage. The charge pumps steer the charge pump output, CPo, to Vcc (pump-up) or ground (pump-down). When locked, CPo is primarily in a TRI-STATE® mode with small corrections. The RF charge pump output current magnitude is programmable from 100 µA to 1.6 mA in 100 µA steps as shown in table in programming description 3.2.2. The IF charge pump is set to either 100µA or 800µA levels using bit IF_R [19] (see programming description 3.1.4).

1.6 Voltage Doubler

The V_{PRF} pin is normally driven from an external power supply over a range of Vcc to 5.5v to provide current for the RF charge pump circuit. An internal voltage doubler circuit connected between the Vcc and V_{PRF} supply pins alternately allows Vcc = 3v (± 10%) users to run the RF charge pump circuit at close to twice the Vcc power supply voltage. The voltage doubler mode is enabled by setting the V2_EN bit (RF_R [22]) to a HIGH level. The voltage doubler's charge pump driver originates from the RF oscillator input (OSCx). The device will not totally powerdown until the V2_EN bit is programmed low. The average delivery current of the doubler is less than the instantaneous current demand of the RF charge pump when active and is thus not capable of sustaining a continuous out of lock condition. A large external capacitor connected to V_{PRF} is therefore needed to control power supply droop when changing frequencies. Refer to the application note AN-1119 for more details.

1.7 MICROWIRE™ Serial Interface

The programmable functions are accessed through the MICROWIRE serial interface. The interface is made of 3 functions: clock, data and latch enable (LE). Serial data for the various counters is clocked in from data on the rising edge of clock, into the 24-bit shift register. Data is entered MSB first. The last two bits decode the internal register address. On the rising edge of LE, data stored in the shift register is loaded into one of the 4 appropriate latches (selected by address bits). A complete programming description is included in the following sections.

1.8 Fo/LD Multifunction Output

The Fo/LD output pin can deliver several internal functions including analog/digital lock detects, and counter outputs. See programming description 3.1.5 for more details.

1.8.1 Lock Detect

A digital filtered lock detect function is included with each phase detector through an internal digital filter to produce a logic level output available on the Fo/LD output pin if selected. The lock detect output is high when the error between the phase detector inputs is less than 15 nsec for 5 consecutive comparison cycles. The lock detect output is low when the error between the phase detector outputs is more than 30 nsec for one comparison cycle. An analog lock detect signal is also selectable. The lock detect output is always low when the PLL is in power down mode. See programming descriptions 3.1.5, 4.6 - 4.8 for more details.

1.9 Power Control

Each PLL is individually power controlled by device enable pins or MICROWIRE power down bits. The enable pins override the power down bits **except for the V2_EN bit**. The RF_EN pin controls the RF PLL; IF_EN pin controls the IF PLL. When both pins are high, the power down bits determine the state of power control (see programming description 3.2.1.2). Activation of any PLL power down mode results in the disabling of the respective N counter and de-biasing of its respective Fin input (to a high impedance state). The R counter functionality also becomes disabled when the power down bit is activated. The reference oscillator block powers down and the OSCin pin reverts to a high impedance state when both RF and IF enable pins or power down bit's are asserted, unless the V2_EN bit (RF_R[22]) is high. Power down forces the respective charge pump and phase comparator logic to a TRI-STATE condition. A power down counter reset function resets both N and R counters. Upon powering up the N counter resumes counting in "close" alignment with the R counter (The maximum error is one prescaler cycle). The MICROWIRE control register remains active and capable of loading and latching in data during all of the power down modes.

Programming Description (Continued)

3.1.3 15-BIT PROGRAMMABLE REFERENCE DIVIDER RATIO (R COUNTER) (IF_R[2]-[16])

IF_R_CNTR/RF_R_CNTR															
Divide Ratio	14	13	12	11	10	9	8	7	6	5	4	3	2	1	0
3	0	0	0	0	0	0	0	0	0	0	0	0	0	1	1
4	0	0	0	0	0	0	0	0	0	0	0	0	1	0	0
-	-	-	-	-	-	-	-	-	-	-	-	-	-	-	-
32,767	1	1	1	1	1	1	1	1	1	1	1	1	1	1	1

Notes: Divide ratio: 3 to 32,767 (Divide ratios less than 3 are prohibited).
RF_R_CNTR/IF_R_CNTR These bits select the divide ratio of the programmable reference dividers.

3.1.4 IF_CP_WORD (IF_R[17]-[18])

IF_CP_WORD	(IF_R [17] - [18])
CP_GAIN_8	IF_PD_POL

BIT	LOCATION	FUNCTION	0	1
CP_GAIN_8	IF_R [18]	IF Charge Pump Current Gain	1X	8X
IF_PD_POL	IF_R [17]	IF Phase Detector Polarity	Negative	Positive

CP_GAIN_8 is used to toggle the IF charge pump current magnitude between 1x mode (100 uA typ) and 8x mode (800uA typ).
IF_PD_POL is set to one when IF VCO characteristics are positive. When IF VCO frequency decreases with increasing control voltage IF_PD_POL should set to zero.

3.1.5 FoLD* Programming Truth Table (IF_R[19]-[21])

FoLD	Fo/LD OUTPUT STATE
0 0 0	IF and RF Analog Lock Detect (Open Drain)
1 0 0	IF Digital Lock Detect
0 1 0	RF Digital Lock Detect
1 1 0	IF and RF Digital Lock Detect
0 0 1	IF R counter
1 0 1	IF N counter
0 1 1	RF R counter
1 1 1	RF N counter

*FoLD - Fout/Lock Detect PROGRAMMING BITS

3.2 RF_R Register

If the Control Bits (CTL [1:0]) are 1 0, data is transferred from the 24-bit shift register into the RF_R register latch which sets the RF PLL 15-bit R counter divide ratio. The divide ratio is programmed using the RF_R_CNTR word as shown in table 3.1.3. The divide ratio must be ≥ 3 . The bits used to control the voltage doubler (V2_EN) and RF Charge Pump (RF_CP_WORD) are detailed in 3.2.2.

MSB				LSB		
DLL_MODE	V2_EN	RF_CP_WORD [4:0]	RF_R_CNTR [14:0]	1	0	
23	22	21	17	16	2 1 0	

Programming Description (Continued)

3.2.1 (RF_R [22 - 23])

DLL_MODE		V2_EN		
BIT	LOCATION	FUNCTION	0	1
DLL_MODE	RF_R [23]	Delay Line Loop Calibration Mode	Slow	Fast
V2_EN	RF_R [22]	RF_Voltage Doubler Enable	Disabled	Enabled

1. V2_EN bit when set high enables the voltage doubler for the RF Charge Pump supply.
2. DLL_MODE bit should be set to one for normal usage.

3.2.2 RF_CP_WORD (RF_R[17]-[21])

CP_8X	CP_4X	CP_2X	CP_1X	RF_PD_POL
-------	-------	-------	-------	-----------

RF_PD_POL (RF_R[17]) should be set to one when RF VCO characteristics are positive. When RF VCO frequency decreases with increasing control voltage RF_PD_POL should be set to zero.

CP_1x, CP_2x, CP_4x, and CP_8x are used to step the RF Charge Pump output current magnitude from 100 uA to 1.6 mA in 100uA steps as shown in the table below.

RF Charge Pump Output Truth Table

ICPo uA (typ)	CP8x	CP4x	CP2x	CP1x
	RF_R[21]	RF_R[20]	RF_R[19]	RF_R[18]
100	0	0	0	0
200	0	0	0	1
300	0	0	1	0
400	0	0	1	1
-	-	-	-	-
900	1	0	0	0
-	-	-	-	-
1600	1	1	1	1

4.0 PROGRAMMABLE DIVIDERS (N COUNTERS)

4.1 IF_N Register

If the Control Bits (CTL [1:0]) are 01, data is transferred from the 24-bit shift register into the IF_N register latch which sets the PLL 15 bit programmable N counter value and various control functions. The IF_N counter consists of the 3-bit swallow counter (A counter), and the 12 bit programmable counter (B counter). Serial data format is shown below in tables 4.1.2 and 4.1.3. The divide ratio (IF_NB_CNTR) must be ≥ 3 . The divide ratio is programmed using the bits IF_N_CNTR as shown in tables 4.1.2 and 4.1.3. The divide ratio must be ≥ 56 . The CMOS [3:0] bits program the 2 CMOS outputs detailed in section 4.4.

MSB				LSB					
IF_CTL_WORD [2:0]	CMOS [3:0]			IF_NB_CNTR [11:0]	IF_NA_CNTR [2:0]		0	1	
23	21	20	17	16	5	4	2	1	0

4.1.1 IF_CTL_WORD (IF_R[21]-[23])

MSB		LSB	
IF_CNT_RST	PWDN_IF	PWDN_MODE	

Note: See section 4.2.1.2 for IF control word truth table.

Programming Description (Continued)

4.1.2 3-BIT IF SWALLOW COUNTER DIVIDE RATIO (IF A COUNTER) (IF_N[2]-[4])

Swallow Count (A)	IF_NA_CNTR		
	2	1	0
0	0	0	0
1	0	0	1
-	-	-	-
7	1	1	1

Note: Swallow Counter Value: 0 to 7
 $IF_NB_CNTR \geq IF_NA_CNTR$
 Minimum continuous count = 56 (A=0, B=7)

4.1.3 12-BIT IF PROGRAMMABLE COUNTER DIVIDE RATIO (IF B COUNTER) (IF_N[5]-[16])

Divide Ratio	IF_NB_CNTR											
	11	10	9	8	7	6	5	4	3	2	1	0
3	0	0	0	0	0	0	0	0	0	0	1	1
4	0	0	0	0	0	0	0	0	0	1	0	0
-	-	-	-	-	-	-	-	-	-	-	-	-
4,095	1	1	1	1	1	1	1	1	1	1	1	1

Note: Divide ratio: 3 to 4095 (Divide ratios less than 3 are prohibited)
 $IF_NB_CNTR \geq IF_NA_CNTR$
 N divider continuous integer divide ratio 56 to 32,767.

4.2 RF_N Register

If the control bits (CTL[2:0]) are 11, data is transferred from the 24-bit shift register into the RF_N register latch which sets the RF PLL 19 bit programmable N counter register and various control functions. The RF N counter consists of the 5-bit swallow counter (A counter) the 10 bit programmable counter (B counter), and 4 bit fractional counter. Serial data format is shown below. The divide ratio (RF_NB_CNTR) must be ≥ 3 , and must be \geq the swallow counter value + 2; $RF_NB_CNTR \geq (RF_NA_CNTR + 2)$.

MSB					LSB				
RF_CTL_WORD [2:0]	RF_NB_CNTR [9:0]	RF_NA_CNTR [4:0]	FRAC_CONT [3:0]	1	1	1	1	1	1
23	21	20	11	10	6	5	2	1	0

4.2.1.1 RF_CTL_WORD (RF_N[21]-[23])

MSB		LSB	
RF_CNT_RST	PWDN_RF	PRESC_SEL	

4.2.1.2 RF/IF Control Word Truth Table

BIT		FUNCTION	0	1
IF_CNT_RST/RF_CNT_RST		IF/RF counter reset	Normal Operation	Reset
PWDN_IF/PWDN_RF		IF/RF power down	Powered up	Powered down
PWDN_MODE		Power down mode select	Asynchronous power down	Synchronous power down
PRESC	LMX2350	Prescaler Modulus select	16/17 (0.5 to 1.2 GHz operation)	32/33 (1.2 to 2.5 GHz operation)
	LMX2352		8/9 (0.25 to 0.5 GHz operation)	16/17 (0.5 to 1.2 GHz operation)

The **Counter Reset** enable bit when activated allows the reset of both N and R counters. Upon powering up, the N counter resumes counting in "close" alignment with the R counter (the maximum error is one prescaler cycle).

Activation of the PLL **power down** bits result in the disabling of the respective N counter divider and de-biasing of its respective fin inputs (to a high impedance state). The respective R counter functionality also becomes disabled when the power down bit is activated. The OSCin pin reverts to a high impedance state when both RF and IF power down bits are asserted. Power down forces the respective charge pump

and phase comparator logic to a TRI-STATE condition. The MICROWIRE control register remains active and capable of loading and latching in data during all of the power down modes.

Both synchronous and asynchronous power down modes are available with the LMX2350 family in order to adapt to different types of applications. The power down mode bit IF_N[21] is used to select between synchronous and asynchronous power down. The MICROWIRE control register remains active and capable of loading and latching in data during all of the power down modes.

Programming Description (Continued)

Synchronous Power down Mode

One of the PLL loops can be synchronously powered down by first setting the power down mode bit HIGH (IF_N[21] = 1) and then asserting its power down bit (IF_N[22] or RF_N[22] = 1). The power down function is gated by the charge pump. Once the power down bit is loaded, the part will go into power down mode upon the completion of a charge pump pulse event.

Asynchronous Power down Mode

One of the PLL loops can be asynchronously powered down by first setting the power down mode bit LOW (IF_N[21] = 0) and then asserting its power down bit (IF_N[22] or RF_N[22] = 1). The power down function is NOT gated by the charge pump. Once the power down bit is loaded, the part will go into power down mode immediately.

Prescaler select is used to set the RF prescaler. The LMX2350 is capable of operating from 500 MHz to 1.2 GHz with the 16/17 prescaler, and 1.2 GHz to 2.5 GHz with the 32/33 prescaler selection. The LMX2352 is capable of operating from 250 MHz to 500 MHz with the 8/9 prescaler, and 500MHz to 1.2GHz with 16/17 prescaler selection.

4.2.2 5-BIT RF SWALLOW COUNTER DIVIDE RATIO (RF A COUNTER) (RF_N[6]-[10])

Swallow Count (A)	RF_NA_CNTR				
	4	3	2	1	0
0	0	0	0	0	0
1	0	0	0	0	1
-	-	-	-	-	-
31	1	1	1	1	1

Note: Swallow Counter Value LMX2350: 0 to 31; LMX2352: 0 to 15
RF_NB_CNTR ≥ RF_NA_CNTR + 2

4.2.3 10-BIT RF PROGRAMMABLE COUNTER DIVIDE RATIO (RF B COUNTER) (RF_N[11]-[20])

Divide Ratio	RF_NB_CNTR									
	9	8	7	6	5	4	3	2	1	0
3	0	0	0	0	0	0	0	0	1	1
4	0	0	0	0	0	0	0	1	0	0
-	-	-	-	-	-	-	-	-	-	-
1,023	1	1	1	1	1	1	1	1	1	1

Note: Divide ratio: 3 to 1023 (Divide ratios less than 3 are prohibited)
RF_NB_CNTR ≥ RF_NA_CNTR + 2

4.2.4 FRACTIONAL MODULUS ACCUMULATOR (FRAC_CNTR) (RF_N[2]-[5])

Fractional Ratio (F)		FRAC_CNTR			
Modulus 15	Modulus 16	RF_N[5]	RF_N[4]	RF_N[3]	RF_N[2]
0	0	0	0	0	0
1/15	1/16	0	0	0	1
2/15	2/16	0	0	1	0
-	-	-	-	-	-
14/15	14/16	1	1	1	0
N/A	15/16	1	1	1	1

4.3 PULSE SWALLOW FUNCTION

$$fvco = [N + F] \times [fosc / R]$$

$$N = (P \times B) + A$$

F: Fractional ratio (contents of FRAC_CNTR divided by the fractional modulus)

fosc: Output frequency of the external reference frequency oscillator

fvco: Output frequency of external voltage controlled oscillator (VCO)

R: Preset divide ratio of binary 15-bit programmable reference counter (3 to 16383)

B: Preset divide ratio of binary 10-bit programmable counter

P: Preset modulus of dual modulus prescaler (LMX2350:RF P=16 or 32, IF P=8)

A: Preset value of binary 4 or 5-bit swallow counter (0 ≤ A ≤ 31 {RF}, 0 ≤ A ≤ 15 {IF}, A+2 ≤ B {RF}, A ≤ B {IF})

(LMX2352:RF P=8 or 16, IF P=8)

4.4 CMOS (Programmable CMOS outputs) (IF_N[17]-[20])

MSB			LSB	
FastLock	TEST	OUT_1	OUT_0	

Note: Test bit is reserved and should be set to zero for normal usage.

Programming Description (Continued)

4.4.1 Programmable CMOS Output Truth Table

BIT	LOCATION	FUNCTION	0	1
OUT_0	IF_N[17]	OUT0 CMOS output pin level set	LOW	HIGH
OUT_1	IF_N[18]	OUT1 CMOS output pin level set	LOW	HIGH
FastLock	IF_N[20]	FastLock mode select	CMOS output	FastLock mode

When the FastLock bit is set to one, **OUT_0** and **OUT_1** are don't care bits. FastLock mode utilizes the OUT0 and OUT1 output pins to synchronously switch between active low and TRI-STATE. The OUT0 = LOW state occurs whenever the RF loop's CP_8X is selected HIGH while the FastLock bit is set HIGH (see programming description 3.2.2). The OUT0 pin reverts to TRI-STATE when the CP_8X bit is LOW. Similarly for the IF loop, the synchronous activation of OUT1 = LOW or TRI-STATE, is dependent on whether the CP_GAIN_8 is high or low respectively (see programming description 3.1.4).

4.5 SERIAL DATA INPUT TIMING

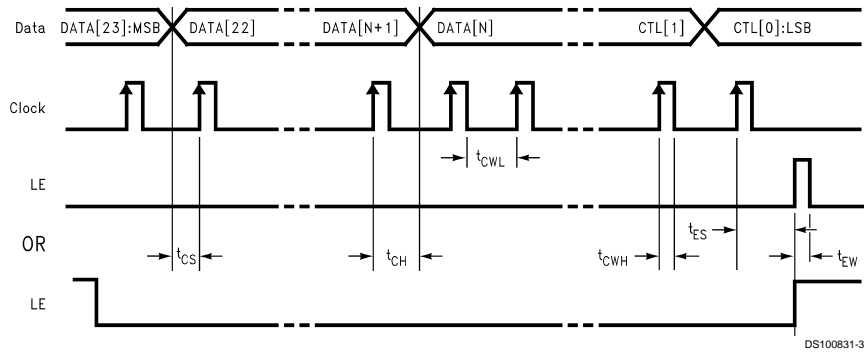

Note: Data shifted into register on clock rising edge. Data is shifted in MSB first.

TEST CONDITIONS: The Serial Data Input Timing is tested using a symmetrical waveform around $V_{cc}/2$. The test waveform has an edge rate of 0.6 V/nsec with amplitudes of 2.2V @ $V_{cc}=2.7$ V and 2.6V @ $V_{cc} = 5.5$ V.

Programming Description (Continued)

4.6 LOCK DETECT DIGITAL FILTER

The Lock Detect Digital Filter compares the difference between the phase of the inputs of the phase detector to a RC generated delay of approximately 15nS. To enter the locked state (Lock = HIGH) the phase error must be less than the 15nS RC delay for 5 consecutive reference cycles. Once in lock (Lock = HIGH), the RC delay is changed to approximately 30nS. To exit the locked state (Lock = LOW), the phase error must become greater than the 30nS RC delay. When the PLL is in the power down mode, Lock is forced LOW. A flow chart of the digital filter is shown at right.

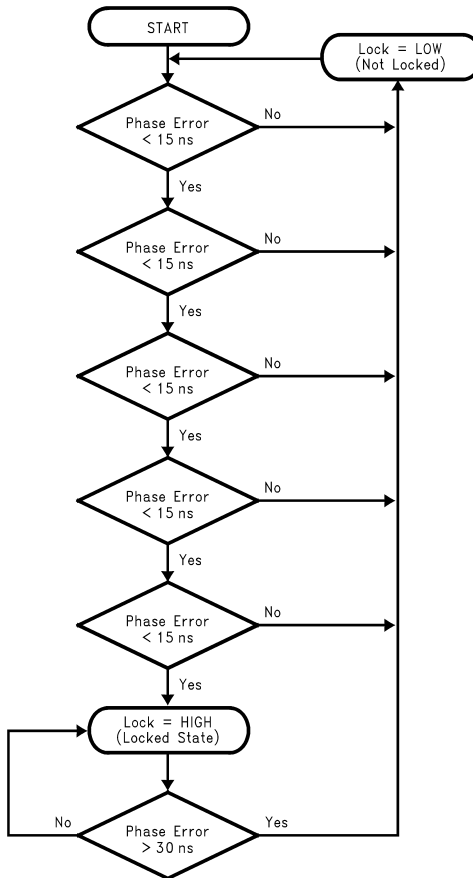

DS100831-4

Programming Description (Continued)

4.7 ANALOG LOCK DETECT FILTER

When the Fo/LD output is configured in analog lock detect mode an external lock detect circuit is needed in order to provide a steady LOW signal when the PLL is in the locked state. A typical circuit is shown below. The fold output is active low (open drain) only when analog lock detect mode is selected.

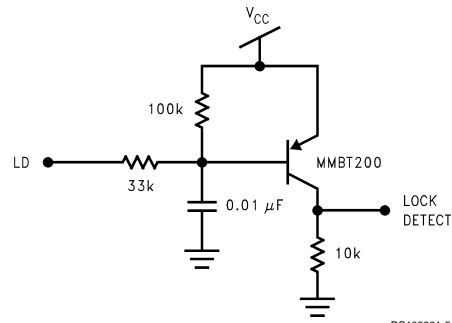

DS100831-5

4.8 TYPICAL LOCK DETECT TIMING

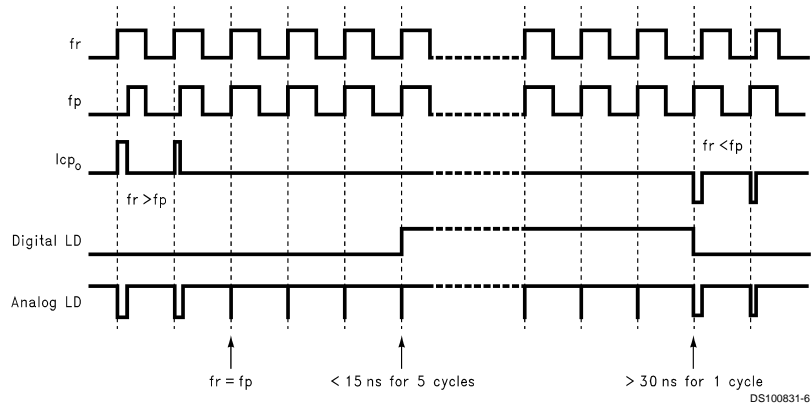

DS100831-6

