

# Round Type

## φ 4.8 mm Series

Conventional Part No.	Global Part No.	Lighting Color
LN21RCPSS	LNG21SLDR	Red
LN31GCPSS	LNG31SMDG	Green
LN41YCPSS	LNG41SNDX	Amber

### ■ Absolute Maximum Ratings (T<sub>a</sub> = 25°C)

Lighting Color	P <sub>D</sub> (mW)	I <sub>F</sub> (mA)	I <sub>FP</sub> (mA)*	V <sub>R</sub> (V)	T <sub>opr</sub> (°C)	T <sub>stg</sub> (°C)
Red	70	25	150	4	-25 ~ +85	-30 ~ +100
Green	90	30	150	4	-25 ~ +85	-30 ~ +100
Amber	90	30	150	4	-25 ~ +85	-30 ~ +100

I<sub>FP</sub>の条件は duty 10% Pulse width 1 msec. The condition of I<sub>FP</sub> is duty 10%, Pulse width 1 msec

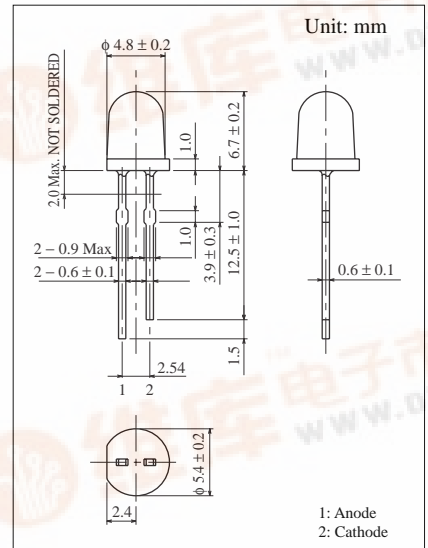

### ■ Electro-Optical Characteristics (T<sub>a</sub> = 25°C)

Conventional Part No.	Lighting Color	Lens Color	I <sub>O</sub>		I <sub>F</sub>	V <sub>F</sub>		λ <sub>P</sub>	Δλ	I <sub>F</sub>	I <sub>R</sub>	
			Typ	Min		Typ	Max				Max	V <sub>R</sub>
LN21RCPSS	Red	Red Clear	4.0	1.5	15	2.2	2.8	700	100	20	5	4
LN31GCPSS	Green	Green Clear	10.0	4.0	20	2.2	2.8	565	30	20	10	4
LN41YCPSS	Amber	Amber Clear	6.0	2.0	20	2.2	2.8	590	30	20	10	4
Unit	—	—	mcd	mcd	mA	V	V	nm	nm	mA	μA	V

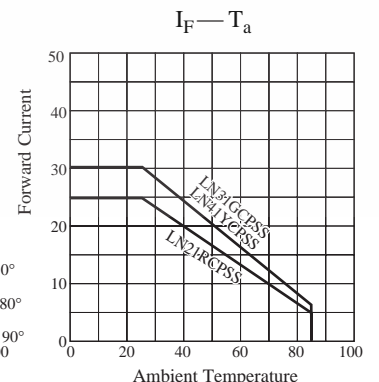
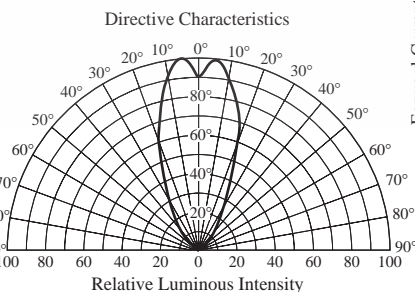
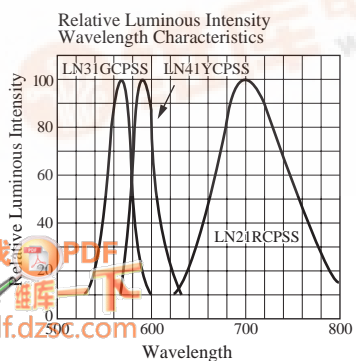
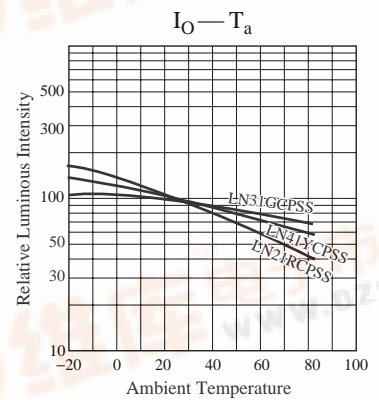
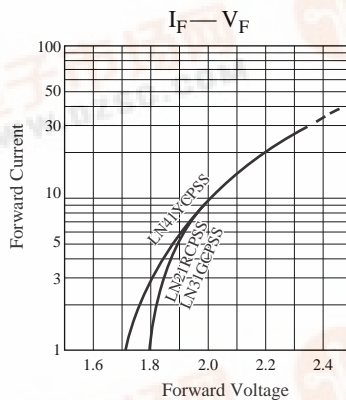
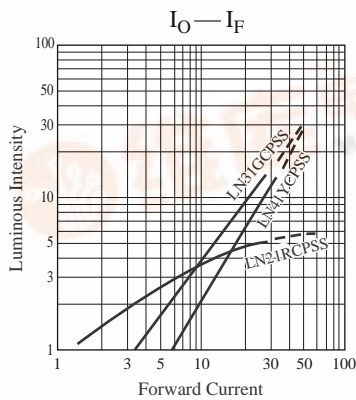

找PDF  
pdf.dzsc.com