

丸形

Round Type

出货

φ 5.0 mm Series

Conventional Part No. Global Part No. Lighting Color
 LN41YPH LNG401YFX Amber
 LN41YCPH LNG401NFX Amber

■ 絶対最大定格 Absolute Maximum Ratings (T_a = 25°C)

Lighting Color	P _D (mW)	I _F (mA)	I _{FP} (mA)*	V _R (V)	T _{opr} (°C)	T _{stg} (°C)
Amber	90	30	150	4	-25 ~ +85	-30 ~ +100

I_{FP}の条件は duty 10% Pulse width 1 msec. The condition of I_{FP} is duty 10%, Pulse width 1 msec

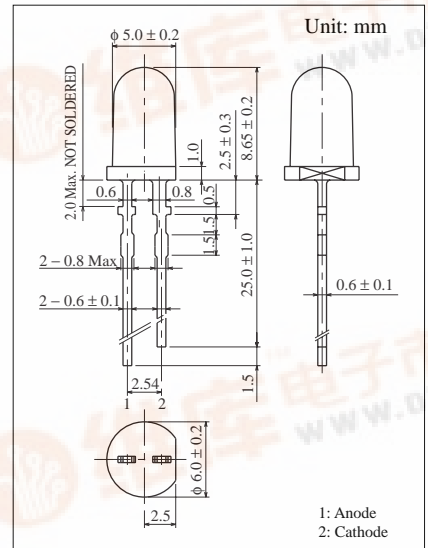

■ 電気的光学的特性 Electro-Optical Characteristics (T_a = 25°C)

Conventional Part No.	Lighting Color	Lens Color	I _O		I _F	V _F		λ _P	Δλ	I _F	I _R	
			Typ	Min		Typ	Max				Typ	Max
LN41YPH	Amber	Amber Diffused	8.0	3.0	20	2.2	2.8	590	30	20	10	4
LN41YCPH	Amber	Amber Clear	20.0	10.0	20	2.2	2.8	590	30	20	10	4
Unit	—	—	mcd	mcd	mA	V	V	nm	nm	mA	μA	V

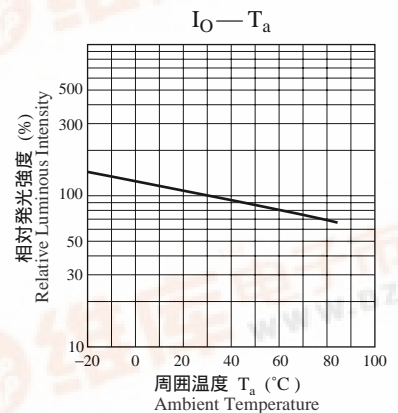
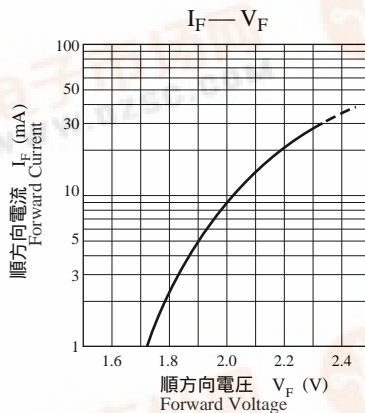
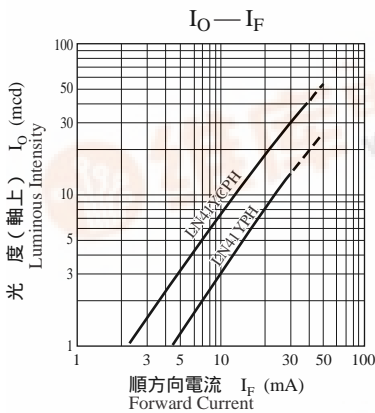

相對發光強度 — 波長特性
Relative Luminous Intensity
Wavelength Characteristics

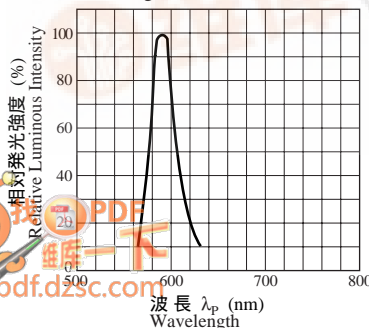

指向特性
Directive Characteristics

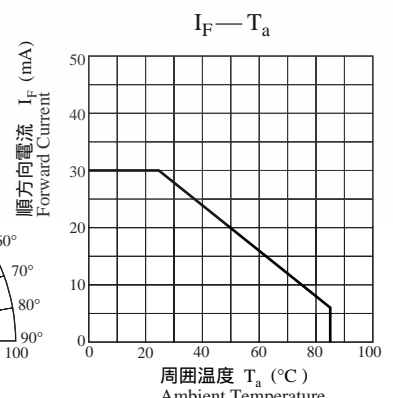
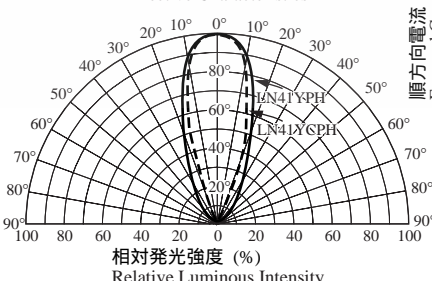

PDF
23
pdf.dzsc.com