

LN54

GaAs Infrared Light Emitting Diode

For optical control systems

Features

- High-power output, high-efficiency : $P_O = 4.6 \text{ mW}$ (typ.)
- Emitted light spectrum suited for silicon photodetectors
- Infrared light emission close to monochromatic light : $\lambda_p = 950 \text{ nm}$ (typ.)
- Small size, thin side-view type package

Absolute Maximum Ratings ($T_a = 25^\circ\text{C}$)

Parameter	Symbol	Ratings	Unit
Power dissipation	P_D	75	mW
Forward current (DC)	I_F	50	mA
Pulse forward current	I_{FP}^*	1	A
Reverse voltage (DC)	V_R	3	V
Operating ambient temperature	T_{opr}	-25 to +85	$^\circ\text{C}$
Storage temperature	T_{stg}	-30 to +100	$^\circ\text{C}$

* $f = 100 \text{ Hz}$, Duty cycle = 0.1 %

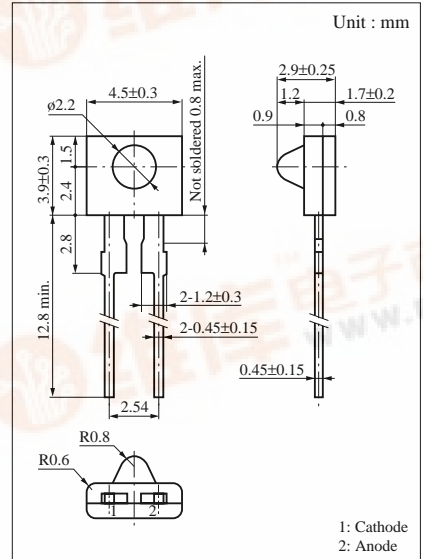

Electro-Optical Characteristics ($T_a = 25^\circ\text{C}$)

Parameter	Symbol	Conditions	min	typ	max	Unit
Radiant power	P_O	$I_F = 50\text{mA}$	2.5	4.6		mW
Peak emission wavelength	λ_p	$I_F = 50\text{mA}$		950		nm
Spectral half band width	$\Delta\lambda$	$I_F = 50\text{mA}$		50		nm
Forward voltage (DC)	V_F	$I_F = 50\text{mA}$			1.5	V
Reverse current (DC)	I_R	$V_R = 3\text{V}$			10	μA
Capacitance between pins	C_t	$V_R = 0\text{V}$, $f = 1\text{MHz}$		35		pF
Half-power angle	θ	The angle in which radiant intensity is 50%		17		deg.

$I_F - T_a$

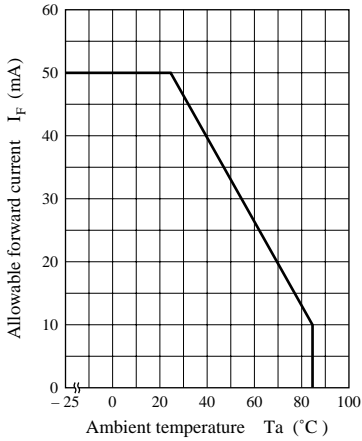

$I_{FP} - \text{Duty cycle}$

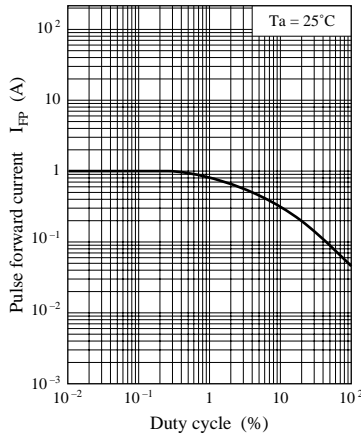

$I_F - V_F$

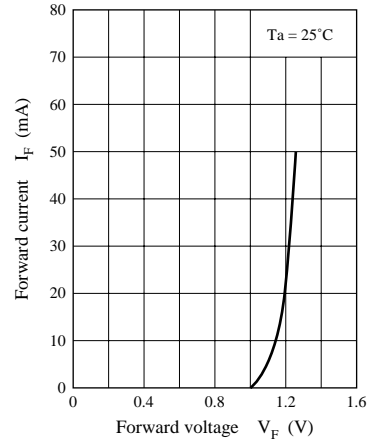

$I_{FP} - V_F$

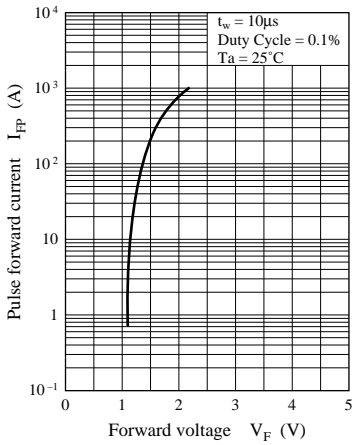

$\Delta P_O - I_F$

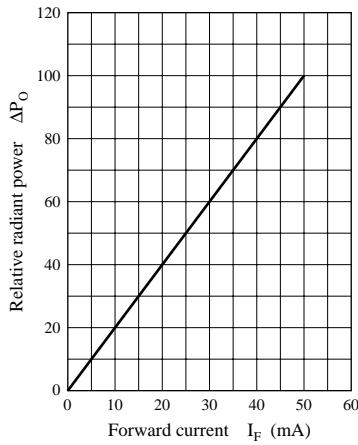

$\Delta P_O - I_{FP}$

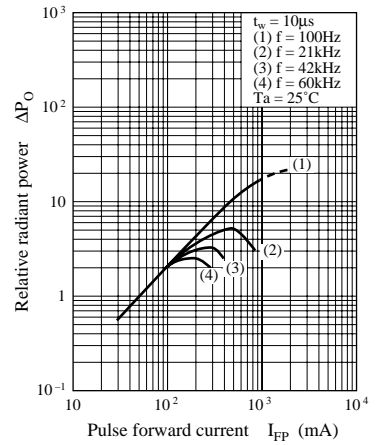

$V_F - T_a$

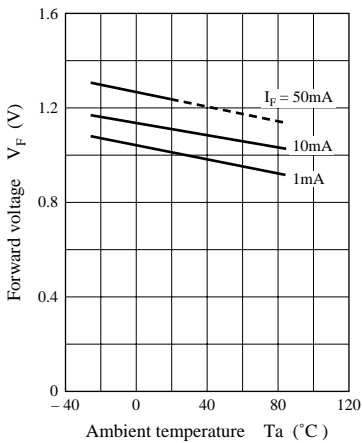

$\Delta P_O - T_a$

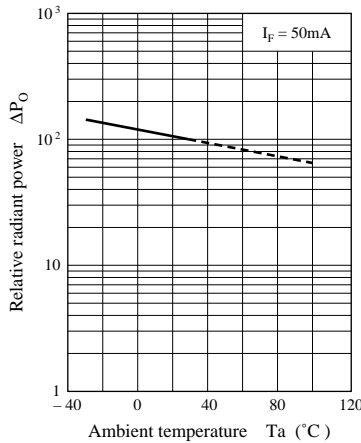

$\lambda_p - T_a$

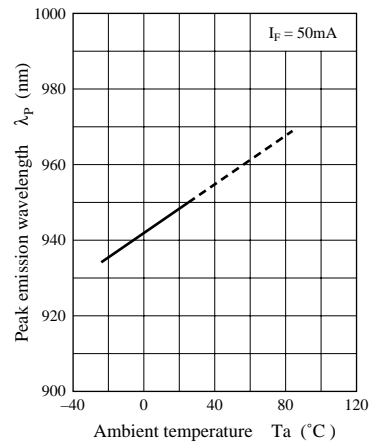

Spectral characteristics

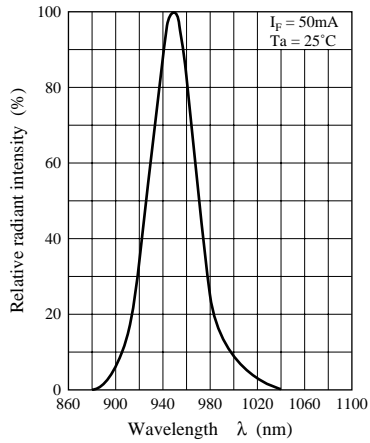

Directivity characteristics

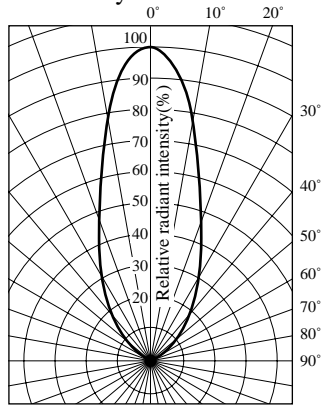

Frequency characteristics

