



August 2005

LPV511

880 nA, Rail-to-Rail Input and Output Operational Amplifier

General Description

The LPV511 is a micropower operational amplifier that operates from a voltage supply range as wide as 2.7V to 12V with guaranteed specifications at 3V, 5V and 12V. The LPV511 exhibits an excellent speed to power ratio, drawing only 880 nA of supply current with a bandwidth of 27 kHz. These specifications make the LPV511 an ideal choice for battery powered systems that require long life through low supply current, such as instrumentation, sensor conditioning and battery current monitoring.

The LPV511 has an input range that includes both supply rails for ground and high side battery sensing applications. The LPV511 output swings within 100 mV of either rail to maximize the signal's dynamic range in low supply applications. In addition, the output is capable of sourcing 650 μA of current when powered by a 12V battery.

The LPV511 is available in the space saving SC70 package which makes it ideal for portable electronics with area constrained PC boards.

Features

(Typical at 3V supply unless otherwise noted)

- Supply voltage range 2.7V to 12V
- Slew rate 7.7 V/ms
- Supply current 880 nA
- Output short circuit current 1.35 mA
- Rail-to-rail input
- Output voltage swing 100 mV from rails
- Bandwidth (C_L = 50 pF, R_L = 1 MΩ) 27 kHz

Applications

- Battery powered systems
- Security systems
- Micropower thermostats
- Solar powered systems
- Portable instrumentation
- Micropower filter
- Remote sensor amplifier

Typical Application

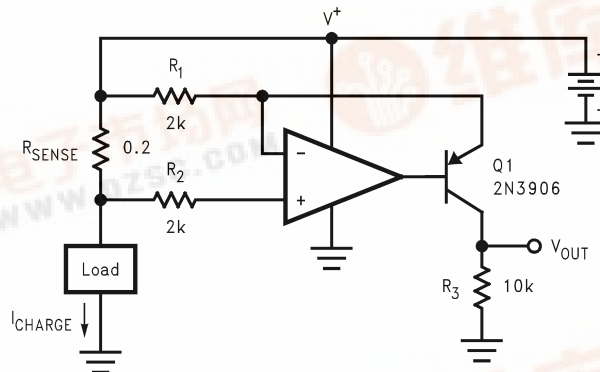

$$V_{OUT} = \frac{R_{SENSE} \cdot R_3}{R_1} \cdot I_{CHARGE} = 1 \Omega \cdot I_{CHARGE}$$

20117003

LPV511 880 nA, Rail-to-Rail Input and Output Operational Amplifier



Absolute Maximum Ratings (Note 1)

If Military/Aerospace specified devices are required, please contact the National Semiconductor Sales Office/Distributors for availability and specifications.

| | |
|---|--|
| ESD Tolerance (Note 2) | |
| Human Body | 2 KV |
| Machine Model | 200V |
| V _{IN} Differential | 2.1V |
| Supply Voltage (V ⁺ - V ⁻) | 13.2V |
| Voltage at Input/Output pins | V ⁺ +0.3V, V ⁻ -0.3V |
| Storage Temperature Range | -65°C to +150°C |
| Short Circuit Duration | (Note 4) |

| | |
|------------------------------------|--------|
| Junction Temperature (Note 3) | +150°C |
| Soldering Information | |
| Infrared or Convection (20 sec) | 235°C |
| Wave Soldering Lead Temp. (10 sec) | 260°C |

Operating Ratings (Note 1)

| | |
|---|----------------|
| Temperature Range (Note 3) | -40°C to +85°C |
| Supply Voltage (V ⁺ - V ⁻) | 2.7V to 12V |
| Package Thermal Resistance (θ _{JA} (Note 3)) | |
| 5-Pin SC70 | 456°C/W |

3V Electrical Characteristics (Note 5)

Unless otherwise specified, all limits are guaranteed for T_J = 25°C, V⁺ = 3V, V⁻ = 0V, V_{CM} = V_O = V⁺/2, and R_L = 100 kΩ to V⁺/2. **Boldface limits apply to the temperature range of -40°C to 85°C.**

| Symbol | Parameter | Conditions | Min (Note 6) | Typ (Note 7) | Max (Note 6) | Units |
|--------------------|--|---|-----------------------|--------------|--------------------|-------|
| V _{OS} | Input Offset Voltage | | | ±0.2 | ±3 ±3.8 | mV |
| TC V _{OS} | Input Offset Average Drift | (Note 8) | | ±5 | | µV/C |
| I _B | Input Bias Current (Note 9) | V _{CM} = 0.5V | -1000 -1600 | -320 | | pA |
| | | V _{CM} = 2.5V | | 110 | 800 1900 | |
| I _{OS} | Input Offset Current | | | ±10 | | pA |
| CMRR | Common Mode Rejection Ratio | V _{CM} Stepped from 0V to 1.5V | 77 70 | 100 | | dB |
| | | V _{CM} Stepped from 2.4V to 3V | 75 68 | 115 | | |
| | | V _{CM} Stepped from 0.5V to 2.5V | 60 56 | 80 | | |
| PSRR | Power Supply Rejection Ratio | V ⁺ = 2.7V to 5V, V _{CM} = 0.5V | 72 68 | 114 | | dB |
| | | V ⁺ = 3V to 5V, V _{CM} = 0.5V | 76 72 | 115 | | |
| | | V ⁺ = 5V to 12V, V _{CM} = 0.5V | 84 80 | 117 | | |
| CMVR | Input Common-Mode Voltage Range | CMRR ≥ 50 dB | -0.1 0 | | 3.1 3.0 | V |
| A _{VOL} | Large Signal Voltage Gain | Sinking, V _O = 2.5V | 75 | 105 | | dB |
| | | Sourcing, V _O = 0.5V | 70 | | | |
| V _O | Output Swing High | V _{ID} = 100 mV | 2.85 2.8 | 2.90 | | V |
| | Output Swing Low | V _{ID} = -100 mV | | 100 | 150 200 | mV |
| I _{SC} | Output Short Circuit Current (Note 10) | Sourcing V _{ID} = 100 mV | | -500 | -225 | µA |
| | | Sinking V _{ID} = -100 mV | 225 | 1350 | | |
| I _S | Supply Current | | | 0.88 | 1.2 1.5 | µA |

3V Electrical Characteristics (Note 5) (Continued)

Unless otherwise specified, all limits are guaranteed for $T_J = 25^\circ\text{C}$, $V^+ = 3\text{V}$, $V^- = 0\text{V}$, $V_{CM} = V_O = V^+/2$, and $R_L = 100\text{ k}\Omega$ to $V^+/2$. **Boldface limits apply to the temperature range of -40°C to 85°C .**

| Symbol | Parameter | Conditions | Min (Note 6) | Typ (Note 7) | Max (Note 6) | Units |
|--------|------------------------------|---|---------------------|-----------------|-----------------|------------------------|
| SR | Slew Rate (Note 11) | $A_V = +1$, V_O ramps from 0.5V to 2.5V | 5.25 3.10 | 7.7 | | V/ms |
| GBW | Gain Bandwidth Product | $R_L = 1\text{ M}\Omega$, $C_L = 50\text{ pF}$ | | 27 | | kHz |
| | Phase Margin | $R_L = 1\text{ M}\Omega$, $C_L = 50\text{ pF}$ | | 53 | | deg |
| e_n | Input-Referred Voltage Noise | $f = 100\text{ Hz}$ | | 320 | | nV/ $\sqrt{\text{Hz}}$ |
| i_n | Input-Referred Current Noise | $f = 10\text{ Hz}$ | | .02 | | pA/ $\sqrt{\text{Hz}}$ |
| | | $f = 1\text{ kHz}$ | | .01 | | |

5V Electrical Characteristics (Note 5)

Unless otherwise specified, all limits are guaranteed for $T_J = 25^\circ\text{C}$, $V^+ = 5\text{V}$, $V^- = 0\text{V}$, $V_{CM} = V_O = V^+/2$, and $R_L = 100\text{ k}\Omega$ to $V^+/2$. **Boldface limits apply to the temperature range of -40°C to 85°C .**

| Symbol | Parameter | Conditions | Min (Note 6) | Typ (Note 7) | Max (Note 6) | Units |
|-------------|--|---|-----------------------|-----------------|--|------------------------|
| V_{OS} | Input Offset Voltage | | | ± 0.2 | ± 3 ± 3.8 | mV |
| TC V_{OS} | Input Offset Average Drift | (Note 8) | | ± 5 | | $\mu\text{V}/\text{C}$ |
| I_B | Input Bias Current (Note 9) | $V_{CM} = 0.5\text{V}$ | -1000 -1600 | -320 | | pA |
| | | $V_{CM} = 4.5\text{V}$ | | 110 | 800 1900 | |
| I_{OS} | Input Offset Current | | | ± 10 | | pA |
| CMRR | Common Mode Rejection Ratio | V_{CM} Stepped from 0V to 2.5V | 80 73 | 115 | | dB |
| | | V_{CM} Stepped from 4.4 to 5V | 75 68 | 107 | | |
| | | V_{CM} Stepped from 0.5 to 4.5V | 65 62 | 87 | | |
| PSRR | Power Supply Rejection Ratio | $V^+ = 2.7\text{V}$ to 5V, $V_{CM} = 0.5\text{V}$ | 72 68 | 114 | | dB |
| | | $V^+ = 3\text{V}$ to 5V, $V_{CM} = 0.5\text{V}$ | 76 72 | 115 | | |
| | | $V^+ = 5\text{V}$ to 12V, $V_{CM} = 0.5\text{V}$ | 84 80 | 117 | | |
| CMVR | Input Common-Mode Voltage Range | CMRR $\geq 50\text{ dB}$ | -0.1 0 | | 5.1 5 | V |
| A_{VOL} | Large Signal Voltage Gain | Sinking, $V_O = 4.5\text{V}$ | 78 | 110 | | dB |
| | | Sourcing, $V_O = 0.5\text{V}$ | 73 | | | |
| V_O | Output Swing High | $V_{ID} = 100\text{ mV}$ | 4.8 4.75 | 4.89 | | V |
| | Output Swing Low | $V_{ID} = -100\text{ mV}$ | | 110 | 200 250 | mV |
| I_{SC} | Output Short Circuit Current (Note 10) | Sourcing to V^- $V_{ID} = 100\text{ mV}$ | | -550 | -225 | μA |
| | | Sinking to V^+ $V_{ID} = -100\text{ mV}$ | 225 | 1350 | | |
| I_S | Supply Current | | | 0.97 | 1.2 1.5 | μA |

5V Electrical Characteristics (Note 5) (Continued)

Unless otherwise specified, all limits are guaranteed for $T_J = 25^\circ\text{C}$, $V^+ = 5\text{V}$, $V^- = 0\text{V}$, $V_{\text{CM}} = V_O = V^+/2$, and $R_L = 100\text{ k}\Omega$ to $V^+/2$. **Boldface limits apply to the temperature range of -40°C to 85°C .**

| Symbol | Parameter | Conditions | Min (Note 6) | Typ (Note 7) | Max (Note 6) | Units |
|--------|------------------------------|---|---------------------|-----------------|-----------------|------------------------|
| SR | Slew Rate (Note 11) | $A_V = +1$, V_O ramps from 0.5V to 4.5V | 5.25 3.10 | 7.5 | | V/ms |
| GBW | Gain Bandwidth Product | $R_L = 1\text{ M}\Omega$, $C_L = 50\text{ pF}$ | | 27 | | kHz |
| | Phase Margin | $R_L = 1\text{ M}\Omega$, $C_L = 50\text{ pF}$ | | 53 | | deg |
| e_n | Input-Referred Voltage Noise | $f = 100\text{ Hz}$ | | 320 | | nV/ $\sqrt{\text{Hz}}$ |
| i_n | Input-Referred Current Noise | $f = 10\text{ Hz}$ | | .02 | | pA/ $\sqrt{\text{Hz}}$ |
| | | $f = 1\text{ kHz}$ | | .01 | | |

12V Electrical Characteristics (Note 5)

Unless otherwise specified, all limits are guaranteed for $T_J = 25^\circ\text{C}$, $V^+ = 12\text{V}$, $V^- = 0\text{V}$, $V_{\text{CM}} = V_O = V^+/2$, and $R_L = 100\text{ k}\Omega$ to $V^+/2$. **Boldface limits apply to the temperature range of -40°C to 85°C .**

| Symbol | Parameter | Conditions | Min (Note 6) | Typ (Note 7) | Max (Note 6) | Units |
|--------------------|--|--|-----------------------|-----------------|--|------------------------|
| V_{OS} | Input Offset Voltage | | | ± 0.2 | ± 3 ± 3.8 | mV |
| TC V_{OS} | Input Offset Average Drift | (Note 8) | | ± 7 | | $\mu\text{V}/\text{C}$ |
| I_B | Input Bias Current (Note 9) | $V_{\text{CM}} = 0.5\text{V}$ | -1000 -1600 | -320 | | pA |
| | | $V_{\text{CM}} = 11.5\text{V}$ | | 110 | 800 1900 | |
| I_{OS} | Input Offset Current | | | ± 10 | | pA |
| CMRR | Common Mode Rejection Ratio | V_{CM} Stepped from 0V to +6V | 75 70 | 115 | | dB |
| | | V_{CM} Stepped from 11.4V to 12V | 75 68 | 110 | | |
| | | V_{CM} Stepped from 0.5V to 11.5 | 70 65 | 97 | | |
| PSRR | Power Supply Rejection Ratio | $V^+ = 2.7\text{V}$ to 5V, $V_{\text{CM}} = 0.5\text{V}$ | 72 68 | 114 | | dB |
| | | $V^+ = 3\text{V}$ to 5V, $V_{\text{CM}} = 0.5\text{V}$ | 76 72 | 115 | | |
| | | $V^+ = 5\text{V}$ to 12V, $V_{\text{CM}} = 0.5\text{V}$ | 84 80 | 117 | | |
| CMVR | Input Common-Mode Voltage Range | CMRR $\geq 50\text{ dB}$ | -0.1 0 | | 12.1 12 | V |
| A_{VOL} | Large Signal Voltage Gain | Sinking, $V_O = 0.5\text{V}$ | 89 | 110 | | dB |
| | | Sourcing, $V_O = 11.5\text{V}$ | 84 | | | |
| V_O | Output Swing High | $V_{\text{ID}} = 100\text{ mV}$ | 11.8 11.72 | 11.85 | | V |
| | Output Swing Low | $V_{\text{ID}} = -100\text{ mV}$ | | 150 | 200 280 | mV |
| I_{SC} | Output Short Circuit Current (Note 10) | Sourcing $V_{\text{ID}} = 100\text{ mV}$ | | -650 | -200 | μA |
| | | Sinking $V_{\text{ID}} = -100\text{ mV}$ | 200 | 1300 | | |
| I_S | Supply Current | | | 1.2 | 1.75 2.5 | μA |

12V Electrical Characteristics (Note 5) (Continued)

Unless otherwise specified, all limits are guaranteed for $T_J = 25^\circ\text{C}$, $V^+ = 12\text{V}$, $V^- = 0\text{V}$, $V_{\text{CM}} = V_O = V^+/2$, and $R_L = 100\text{ k}\Omega$ to $V^+/2$. **Boldface limits apply to the temperature range of -40°C to 85°C .**

| Symbol | Parameter | Conditions | Min (Note 6) | Typ (Note 7) | Max (Note 6) | Units |
|--------|------------------------------|---|---------------------|-----------------|-----------------|------------------------------|
| SR | Slew Rate (Note 11) | $A_V = +1$, V_O ramped from 1V to 11V | 5.25 3.10 | 7.0 | | V/ms |
| GBW | Gain Bandwidth Product | $R_L = 1\text{ M}\Omega$, $C_L = 50\text{ pF}$ | | 25 | | kHz |
| | Phase Margin | $R_L = 1\text{ M}\Omega$, $C_L = 50\text{ pF}$ | | 52 | | deg |
| e_n | Input-Referred Voltage Noise | $f = 100\text{ Hz}$ | | 320 | | $\text{nV}/\sqrt{\text{Hz}}$ |
| i_n | Input-Referred Current Noise | $f = 10\text{ Hz}$ | | .02 | | $\text{pA}/\sqrt{\text{Hz}}$ |
| | | $f = 1\text{ kHz}$ | | .01 | | |

Note 1: Absolute Maximum Ratings indicate limits beyond which damage to the device may occur. Operating Ratings indicate conditions for which the device is intended to be functional, but specific performance is not guaranteed. For guaranteed specifications and the test conditions, see the Electrical Characteristics Tables.

Note 2: Human Body Model: 1.5 k Ω in series with 100 pF. Machine Model: 0 Ω in series with 200 pF.

Note 3: The maximum power dissipation is a function of $T_{J(\text{MAX})}$, θ_{JA} , and T_A . The maximum allowable power dissipation at any ambient temperature is $P_D = (T_{J(\text{MAX})} - T_A) / \theta_{JA}$. All numbers apply for packages soldered directly onto a PC board.

Note 4: Output short circuit duration is infinite for $V^+ < 6\text{V}$ at room temperature and below. For $V^+ > 6\text{V}$, allowable short circuit duration is 1.5 ms.

Note 5: Electrical table values apply only for factory testing conditions at the temperature indicated. Factory testing conditions result in very limited self-heating of the device.

Note 6: Limits are 100% production tested at 25 $^\circ\text{C}$. Limits over the operating temperature range are guaranteed through correlations using the Statistical Quality Control (SQC) method.

Note 7: Typical values represent the most likely parametric norm at the time of characterization.

Note 8: Offset voltage average drift is determined by dividing the change in V_{OS} at temperature extremes into the total temperature change.

Note 9: Positive current corresponds to current flowing into the device.

Note 10: The Short Circuit Test is a momentary test. See (Note 4).

Note 11: Slew rate is the average of the rising and falling slew rates.

Connection Diagram

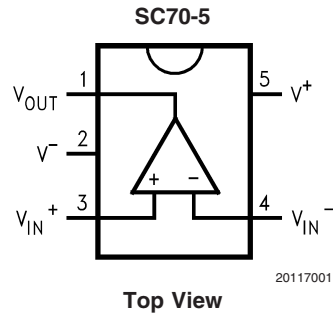

Ordering Information

| Package | Part Number | Package Marking | Transport Media | NSC Drawing |
|------------|-------------|-----------------|------------------------|-------------|
| 5-Pin SC70 | LPV511MG | A91 | 1k Units Tape and Reel | MA005A |
| | LPV511MGX | | 3k Units Tape and Reel | |

Simplified Schematic

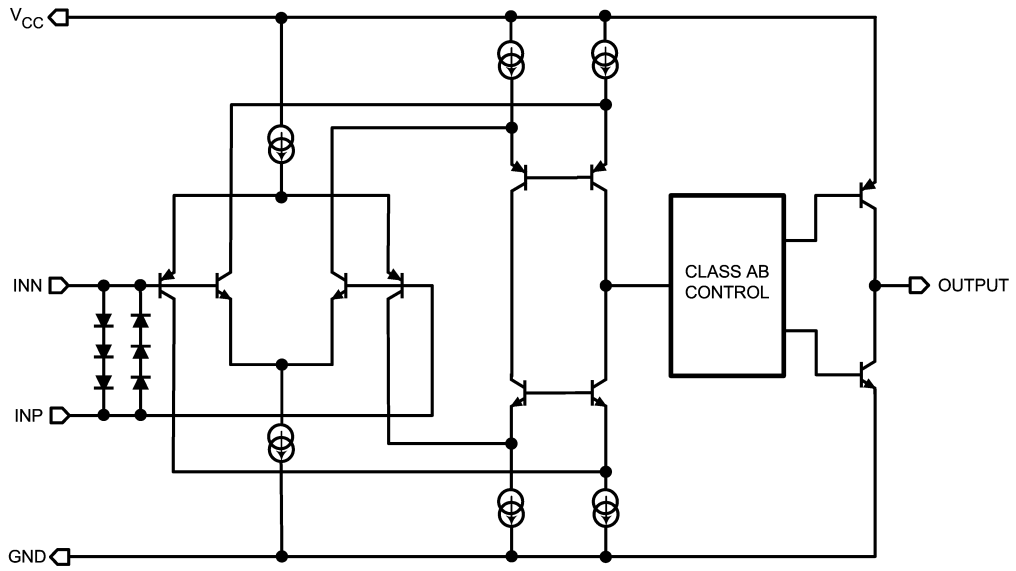

Typical Performance Characteristics At $T_J = 25^\circ\text{C}$, unless otherwise specified.

Supply Current vs. Supply Voltage

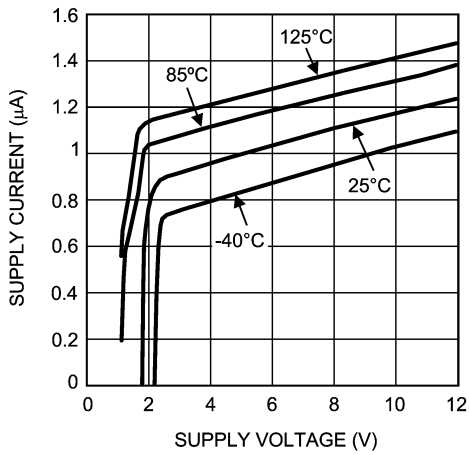

Input Offset Voltage vs. Input Common Mode

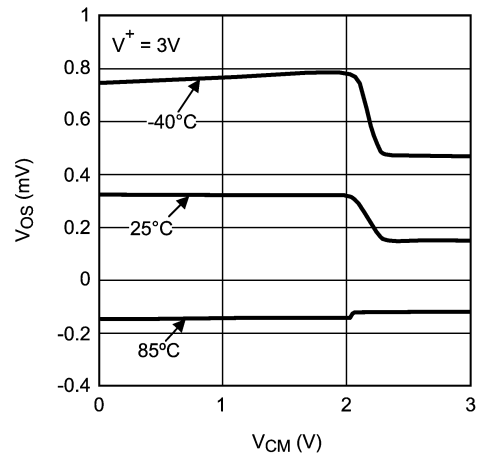

Input Offset Voltage vs. Input Common Mode

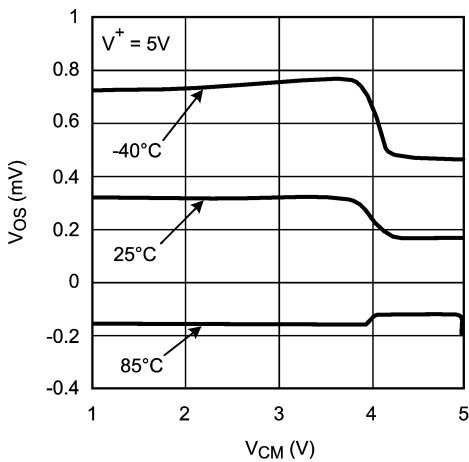

Input Offset Voltage vs. Input Common Mode

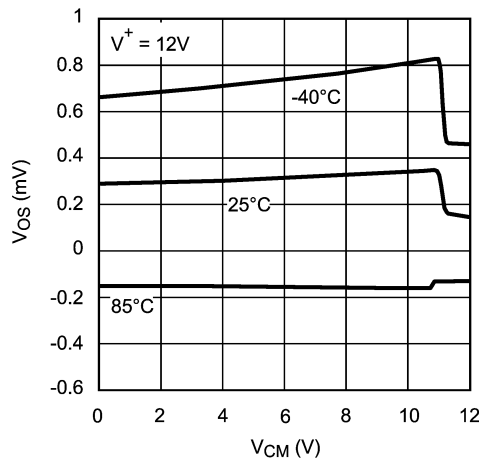

Sourcing Current vs. Output Voltage

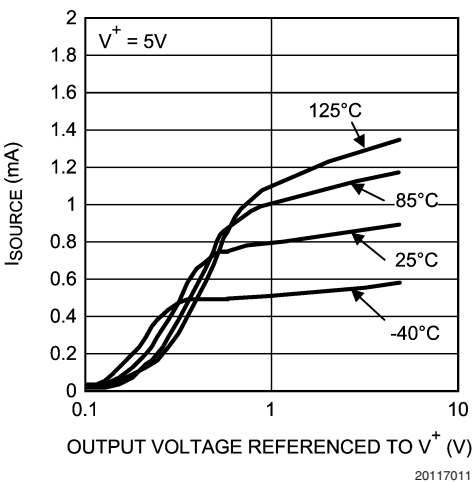

Sinking Current vs. Output Voltage

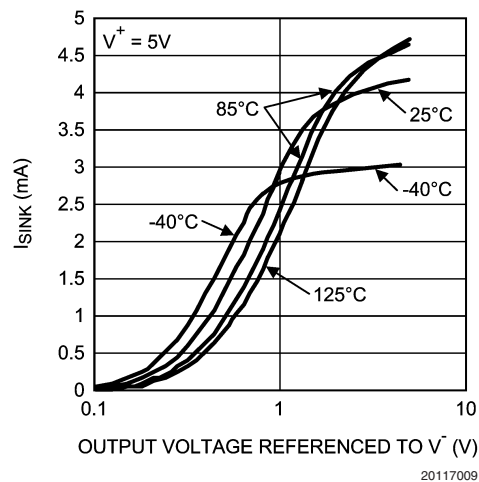

Typical Performance Characteristics At $T_J = 25^\circ\text{C}$, unless otherwise specified. (Continued)

Sourcing Current vs. Output Voltage

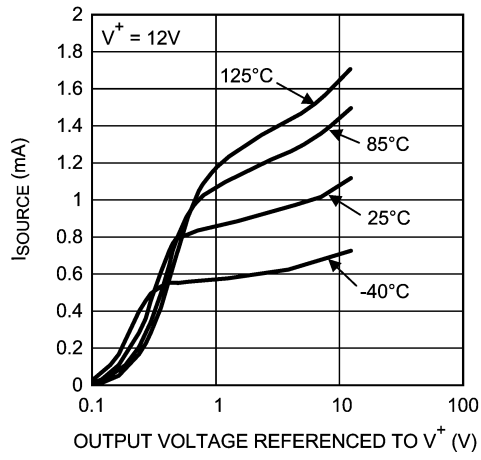

20117010

Sinking Current vs. Output Voltage

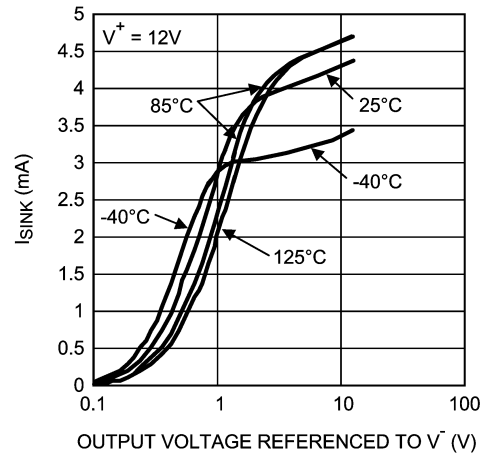

20117008

Input Bias Current vs. Common Mode Voltage

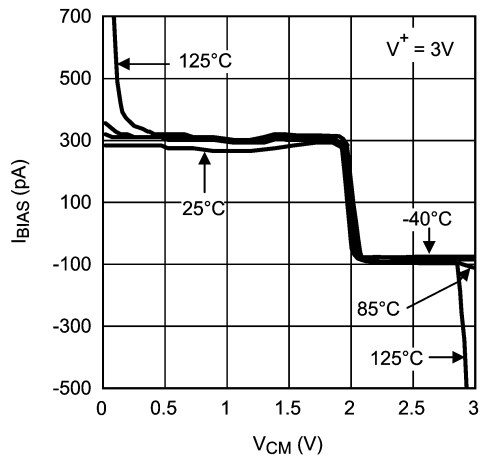

20117014

Input Bias Current vs. Common Mode Voltage

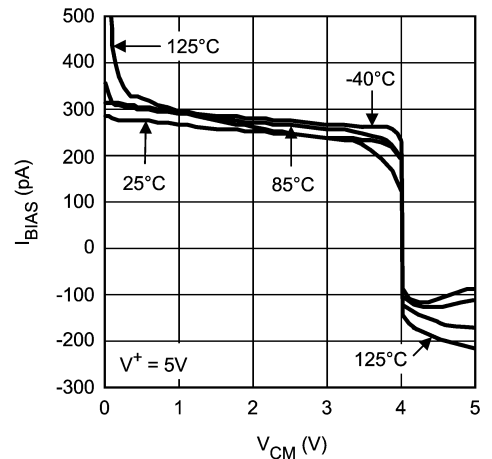

20117015

Input Bias Current vs. Common Mode Voltage

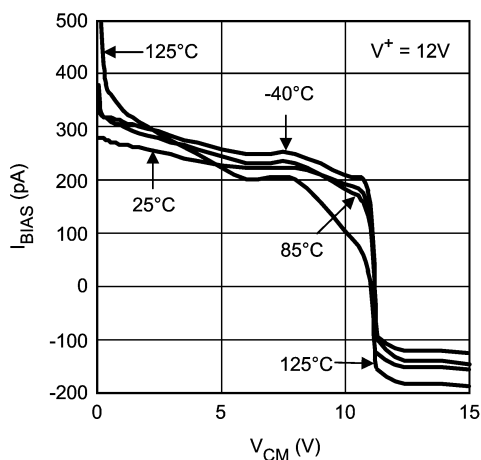

20117016

PSRR vs. Frequency

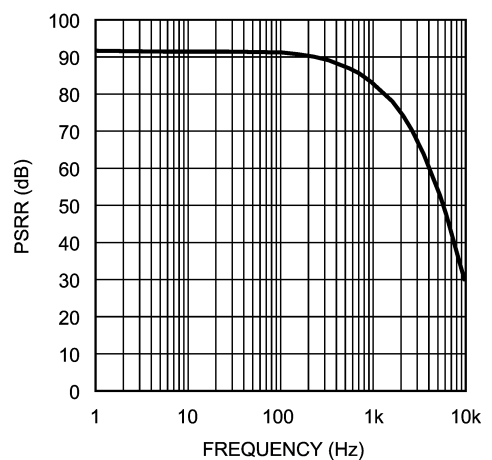

20117027

Typical Performance Characteristics At $T_J = 25^\circ\text{C}$, unless otherwise specified. (Continued)

Frequency Response vs. Temperature

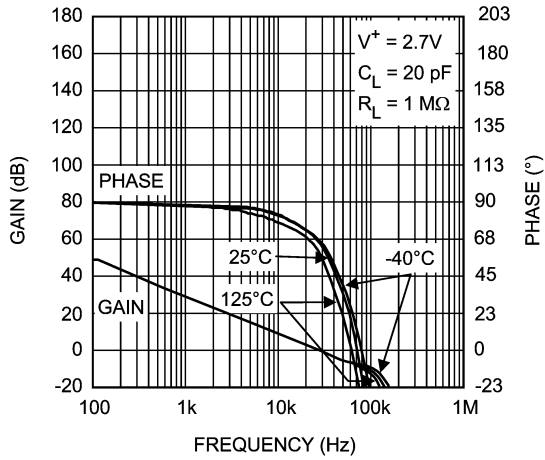

20117023

Frequency Response vs. Temperature

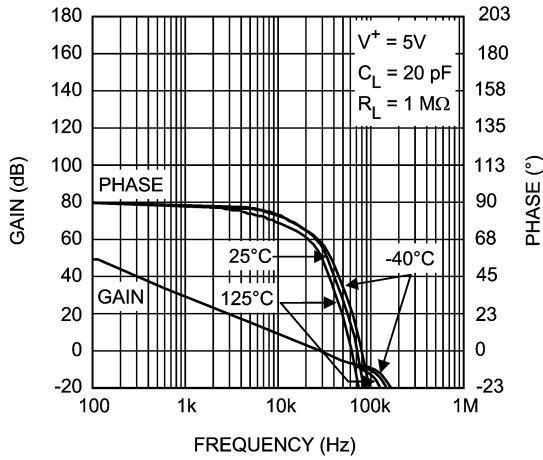

20117024

Frequency Response vs. Temperature

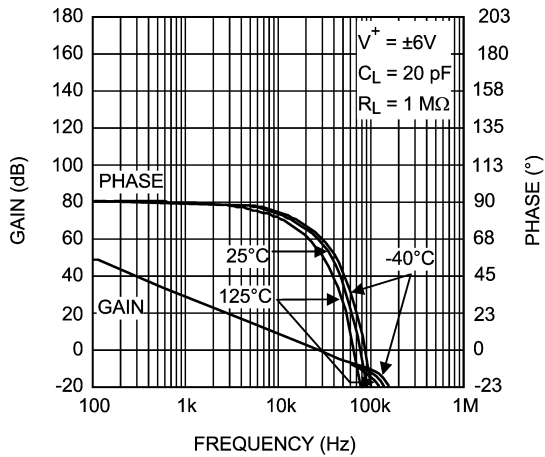

20117022

Frequency Response vs. R_L

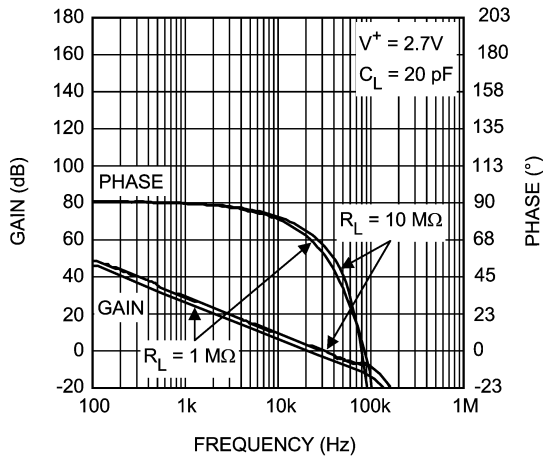

20117020

Frequency Response vs. R_L

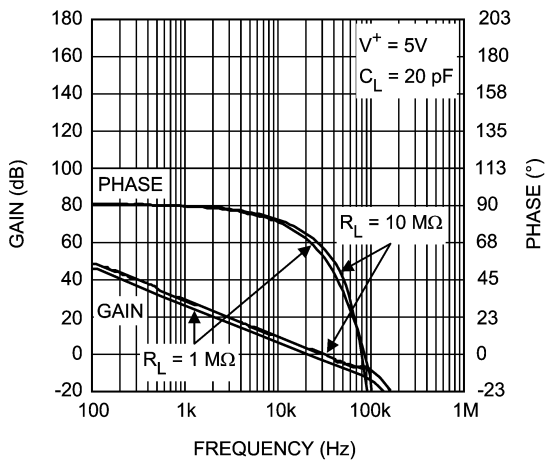

20117021

Frequency Response vs. R_L

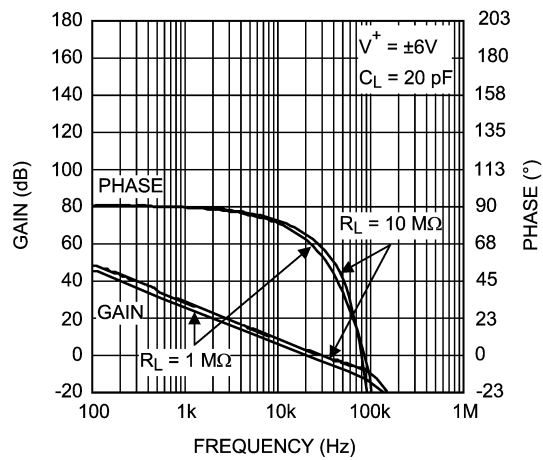

20117019

Typical Performance Characteristics At $T_J = 25^\circ\text{C}$, unless otherwise specified. (Continued)

Frequency Response vs. C_L

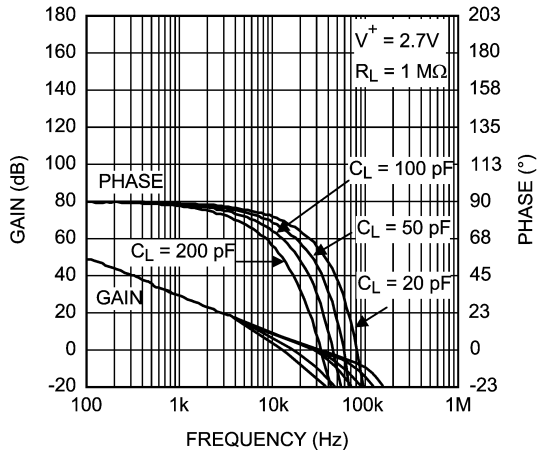

20117017

Frequency Response vs. C_L

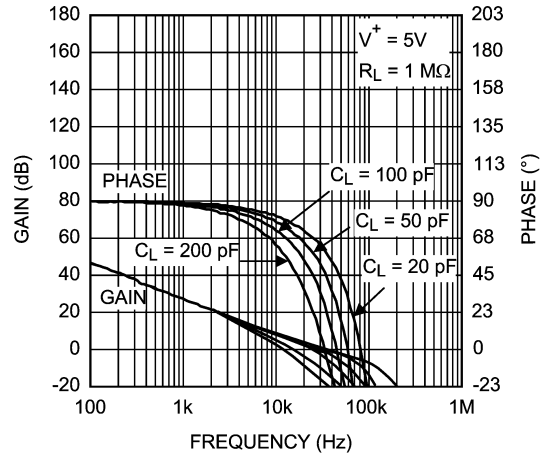

20117018

Frequency Response vs. C_L

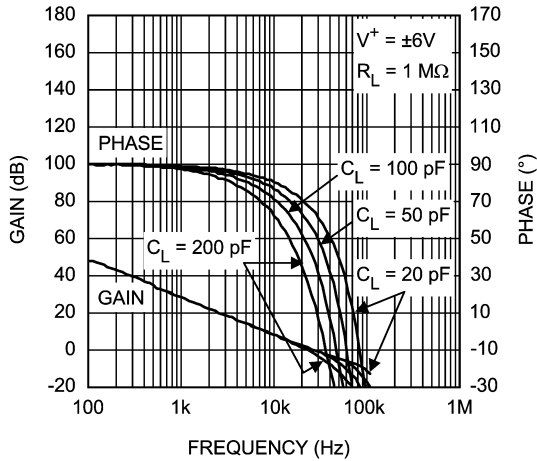

20117013

Voltage Noise vs. Frequency

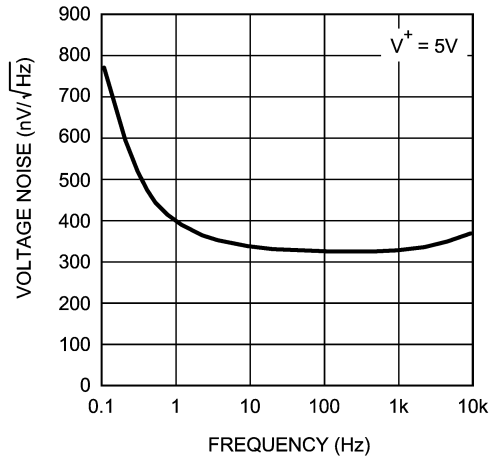

20117026

Non-Inverting Small Signal Pulse Response

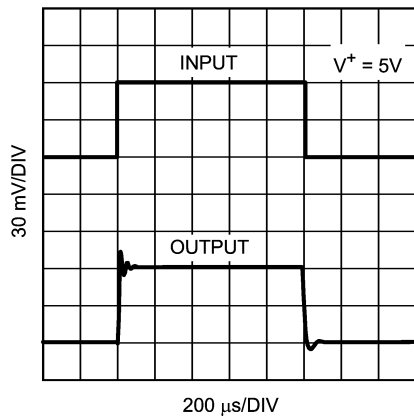

20117031

Non-Inverting Large Signal Pulse Response

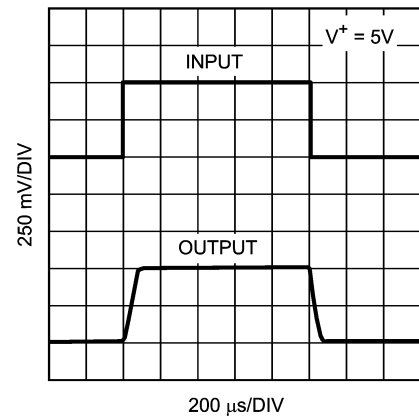

20117030

Typical Performance Characteristics At $T_J = 25^\circ\text{C}$, unless otherwise specified. (Continued)

Inverting Small Signal Pulse Response

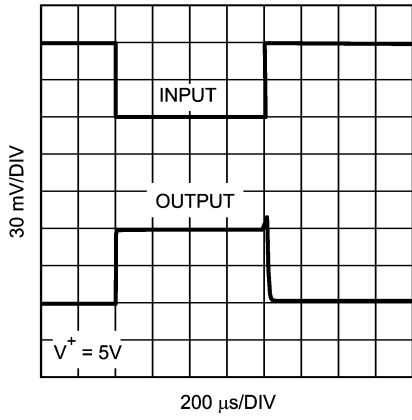

Inverting Large Signal Pulse Response

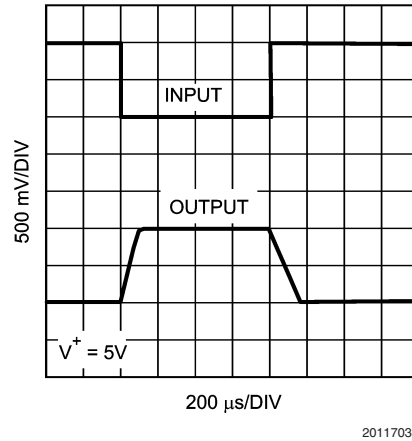

Application Notes

The LPV511 is fabricated with National Semiconductor's state-of-the-art VIP50C process.

INPUT STAGE

The LPV511 has a rail-to-rail input which provides more flexibility for the system designer. As can be seen from the simplified schematic, rail-to-rail input is achieved by using in parallel, one PNP differential pair and one NPN differential pair. When the common mode input voltage (V_{CM}) is near V^+ , the NPN pair is on and the PNP pair is off. When V_{CM} is near V^- , the NPN pair is off and the PNP pair is on. When V_{CM} is between V^+ and V^- , internal logic decides how much current each differential pair will get. This special logic ensures stable and low distortion amplifier operation within the entire common mode voltage range.

Because both input stages have their own offset voltage (V_{OS}) characteristic, the offset voltage of the LPV511 becomes a function of V_{CM} . V_{OS} has a crossover point at 1.0V below V^+ . Refer to the ' V_{OS} vs. V_{CM} ' curve in the Typical Performance Characteristics section. Caution should be taken in situations where the input signal amplitude is comparable to the V_{OS} value and/or the design requires high accuracy. In these situations, it is necessary for the input signal to avoid the crossover point.

The input bias current, I_B will change in value and polarity as the input crosses the transition region. In addition, parameters such as PSRR and CMRR which involve the input offset voltage will also be affected by changes in V_{CM} across the differential pair transition region.

Differential input voltage is the difference in voltage between the non-inverting (+) input and the inverting input (-) of the op amp. Due to the three series diodes across the two inputs, the absolute maximum differential input voltage is $\pm 2.1V$. This may not be a problem to most conventional op amp designs; however, designers should avoid using the LPV511 as a comparator.

OUTPUT STAGE

The LPV511 output voltage swing 100 mV from rails @ 3V supply, which provides the maximum possible dynamic range at the output. This is particularly important when operating on low supply voltages.

The LPV511 Maximum Output Voltage Swing defines the maximum swing possible under a particular output load. The LPV511 output swings 110 mV from the rail @ 5V supply with an output load of 100 k Ω .

DRIVING CAPACITIVE LOAD

The LPV511 is unity gain stable. However, the unity gain follower is the most sensitive configuration to capacitive load. Direct capacitive loading reduces the phase margin of the op amp. When the output is required to drive a large capacitive load, greater than 100 pF, a small series resistor at the output of the amplifier improves the phase margin (see Figure 1).

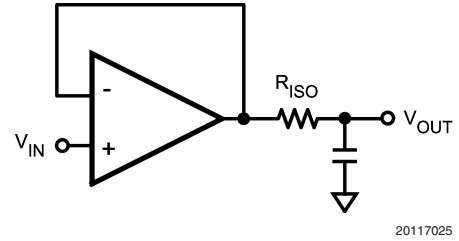

20117025

FIGURE 1. Resistive Isolation of Capacitive Load

POWER SUPPLIES AND LAYOUT

The LPV511 operates from a single 2.7V to 12V power supply. It is recommended to bypass the power supplies with a 0.1 μF ceramic capacitor placed close to the V^+ and V^- pins.

Ground layout improves performance by decreasing the amount of stray capacitance and noise at the op amp's inputs and outputs. To decrease stray capacitance, minimize PC board trace lengths and resistor leads, and place external components close to the op amps's pins.

Typical Applications

BATTERY CURRENT SENSING

The rail-to-rail common mode input range and the very low quiescent current make the LPV511 ideal to use in high side and low side battery current sensing applications. The high side current sensing circuit in Figure 2 is commonly used in a battery charger to monitor the charging current in order to prevent over charging. A sense resistor R_{SENSE} is connected to the battery directly.

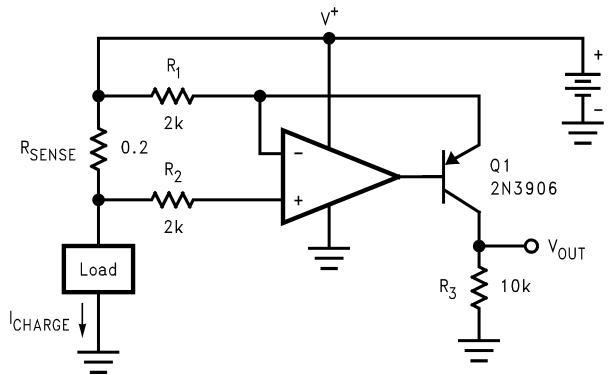

$$V_{OUT} = \frac{R_{SENSE} \cdot R_3}{R_1} \cdot I_{CHARGE} = 1\Omega \cdot I_{CHARGE}$$

20117003

FIGURE 2. High Side Current Sensing

Typical Applications (Continued)

SUMMING AMPLIFIER

The LPV511 operational amplifier is a perfect fit in a summing amplifier circuit because of the rail-to-rail input and output and the sub-micro Amp quiescent current. In this configuration, the amplifier outputs the sum of the three input voltages.

$$V_{OUT} = R_F \left(\frac{V_{REF} - V_1}{R_1} + \frac{V_{REF} - V_2}{R_2} + \frac{V_{REF} - V_3}{R_3} \right) + V_{REF}$$

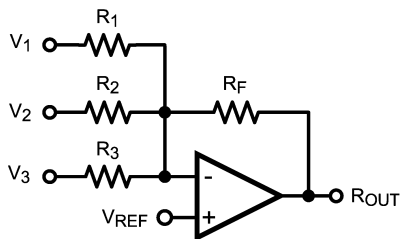

20117029

FIGURE 3. Summing Amplifier Circuit

Physical Dimensions inches (millimeters) unless otherwise noted

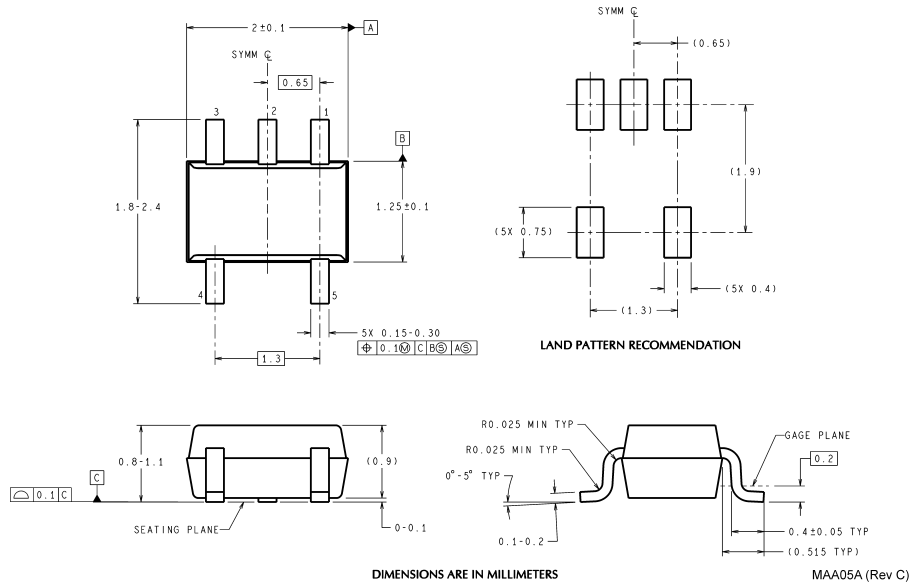

**5-Pin SC70
NS Package Number MAA05A**

National does not assume any responsibility for use of any circuitry described, no circuit patent licenses are implied and National reserves the right at any time without notice to change said circuitry and specifications.

For the most current product information visit us at www.national.com.

LIFE SUPPORT POLICY

NATIONAL'S PRODUCTS ARE NOT AUTHORIZED FOR USE AS CRITICAL COMPONENTS IN LIFE SUPPORT DEVICES OR SYSTEMS WITHOUT THE EXPRESS WRITTEN APPROVAL OF THE PRESIDENT AND GENERAL COUNSEL OF NATIONAL SEMICONDUCTOR CORPORATION. As used herein:

1. Life support devices or systems are devices or systems which, (a) are intended for surgical implant into the body, or (b) support or sustain life, and whose failure to perform when properly used in accordance with instructions for use provided in the labeling, can be reasonably expected to result in a significant injury to the user.
2. A critical component is any component of a life support device or system whose failure to perform can be reasonably expected to cause the failure of the life support device or system, or to affect its safety or effectiveness.

BANNED SUBSTANCE COMPLIANCE

National Semiconductor manufactures products and uses packing materials that meet the provisions of the Customer Products Stewardship Specification (CSP-9-111C2) and the Banned Substances and Materials of Interest Specification (CSP-9-111S2) and contain no "Banned Substances" as defined in CSP-9-111S2.

Leadfree products are RoHS compliant.

**National Semiconductor
Americas Customer
Support Center**
Email: new.feedback@nsc.com
Tel: 1-800-272-9959

**National Semiconductor
Europe Customer Support Center**
Fax: +49 (0) 180-530 85 86
Email: europe.support@nsc.com
Deutsch Tel: +49 (0) 69 9508 6208
English Tel: +44 (0) 870 24 0 2171
Français Tel: +33 (0) 1 41 91 8790

**National Semiconductor
Asia Pacific Customer
Support Center**
Email: ap.support@nsc.com

**National Semiconductor
Japan Customer Support Center**
Fax: 81-3-5639-7507
Email: jpn.feedback@nsc.com
Tel: 81-3-5639-7560